

**DISCRETE SEMICONDUCTORS**

# DATA SHEET

## **BLV904** UHF power transistor

Product specification  
Supersedes data of 1996 Feb 08

1997 Jul 15

# UHF power transistor

# BLV904

### FEATURES

- Emitter ballasting resistors for optimum temperature profile
- Gold metallization ensures excellent reliability
- Internal input matching to achieve high power gain and easy design of wideband circuits.

### APPLICATIONS

- Common emitter class-AB operation in base stations in the 820 to 960 MHz frequency range.

### DESCRIPTION

NPN silicon planar epitaxial power transistor in an 8-lead SOT409B SMD package with ceramic cap. All leads are isolated from the mounting base.

### PINNING - SOT409B

| PIN        | DESCRIPTION |
|------------|-------------|
| 1, 4, 5, 8 | emitter     |
| 2, 3       | base        |
| 6, 7       | collector   |

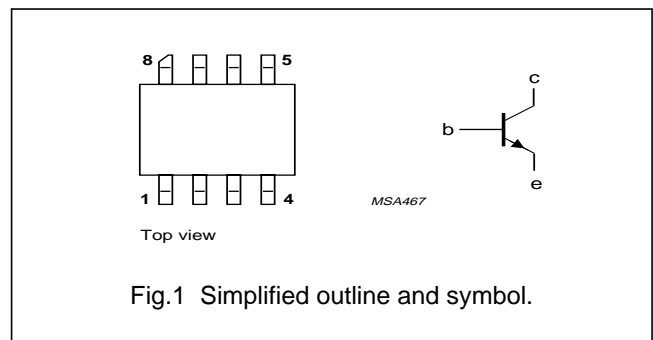

### QUICK REFERENCE DATA

RF performance at  $T_{mb} = 25\text{ °C}$  in a common emitter test circuit.

| MODE OF OPERATION | f (MHz)                  | $V_{CE}$ (V) | $P_L$ (W) | $G_p$ (dB) | $\eta_c$ (%) | $d_{im}$ (dBc) |
|-------------------|--------------------------|--------------|-----------|------------|--------------|----------------|
| CW, class-AB      | 960                      | 26           | 5         | $\geq 13$  | $\geq 50$    | –              |
| 2-tone, class-AB  | $f_1 = 960; f_2 = 960.1$ | 26           | 5 (PEP)   | typ. 15.5  | typ. 40      | typ. -30       |

UHF power transistor

BLV904

**LIMITING VALUES**

In accordance with the Absolute Maximum Rating System (IEC 134).

| SYMBOL             | PARAMETER                      | CONDITIONS                      | MIN. | MAX. | UNIT |
|--------------------|--------------------------------|---------------------------------|------|------|------|
| V <sub>CBO</sub>   | collector-base voltage         | open emitter                    | –    | 60   | V    |
| V <sub>CEO</sub>   | collector-emitter voltage      | open base                       | –    | 28   | V    |
| V <sub>EBO</sub>   | emitter-base voltage           | open collector                  | –    | 4    | V    |
| I <sub>C</sub>     | collector current (DC)         |                                 | –    | 1.2  | A    |
| I <sub>C(AV)</sub> | collector current (average)    |                                 | –    | 1.2  | A    |
| P <sub>tot</sub>   | total power dissipation        | T <sub>mb</sub> = 25 °C; note 1 | –    | 17   | W    |
| T <sub>stg</sub>   | storage temperature            |                                 | –65  | +150 | °C   |
| T <sub>j</sub>     | operating junction temperature |                                 | –    | 200  | °C   |

**Note**

1. Transistor with metallized ground plane mounted on a printed-circuit board, see “Mounting and soldering recommendations in the General part of handbook SC19a”.

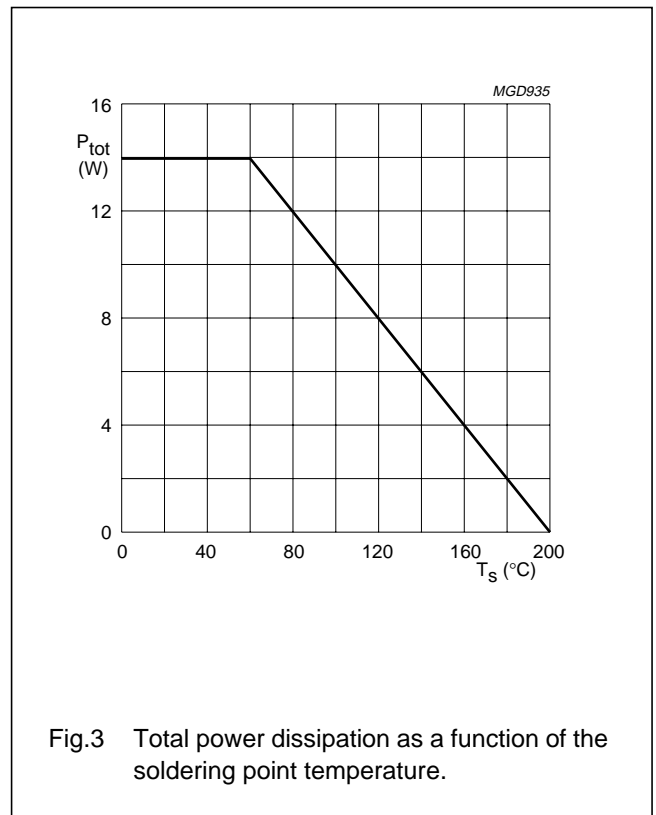
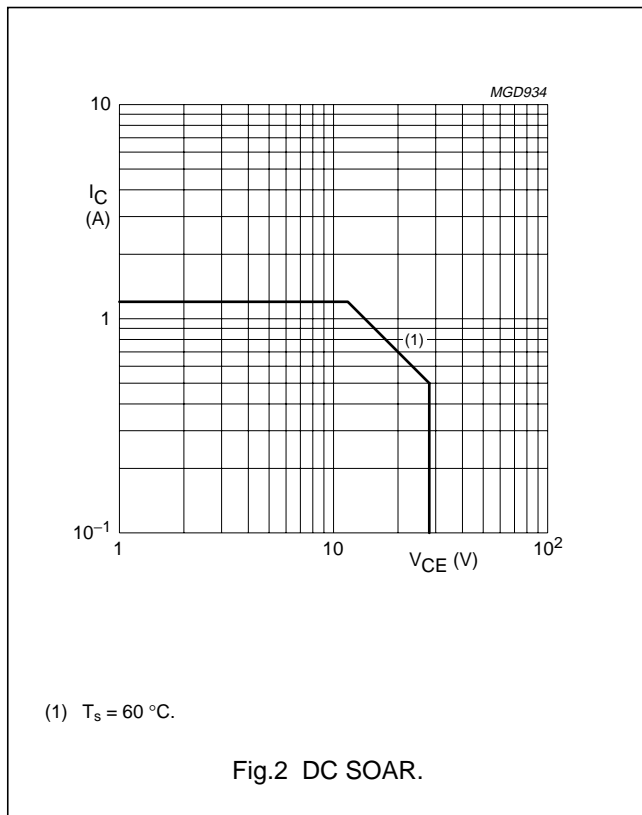

UHF power transistor

BLV904

THERMAL CHARACTERISTICS

| SYMBOL         | PARAMETER   | CONDITIONS   | VALUE | UNIT |
|----------------|---|--|-------|------|
| $R_{th\ j-mb}$ | thermal resistance from junction to mounting base | $P_{tot} = 17\ W$ ; $T_{mb} = 25\ ^\circ C$ ; note 1 | 10    | K/W  |

Note

1. Transistor with metallized ground plane mounted on a printed-circuit board, see "Mounting and soldering recommendations in the General part of handbook SC19a".

CHARACTERISTICS

$T_j = 25\ ^\circ C$  unless otherwise specified.

| SYMBOL        | PARAMETER                           | CONDITIONS  | MIN. | TYP. | MAX. | UNIT |
|---------------|-------------------------------------|---|------|------|------|------|
| $V_{(BR)CBO}$ | collector-base breakdown voltage    | open emitter; $I_C = 5\ mA$                       | 60   | –    | –    | V    |
| $V_{(BR)CEO}$ | collector-emitter breakdown voltage | open base; $I_C = 10\ mA$                         | 28   | –    | –    | V    |
| $V_{(BR)EBO}$ | emitter-base breakdown voltage      | open collector; $I_E = 0.5\ mA$                   | 4    | –    | –    | V    |
| $I_{CES}$     | collector leakage current           | $V_{CE} = 26\ V$ ; $V_{BE} = 0$                   | –    | –    | 1.3  | mA   |
| $h_{FE}$      | DC current gain                     | $V_{CE} = 26\ V$ ; $I_C = 600\ mA$                | 30   | –    | 120  |      |
| $C_c$         | collector capacitance               | $V_{CB} = 26\ V$ ; $I_E = i_e = 0$ ; $f = 1\ MHz$ | –    | 6    | –    | pF   |
| $C_{re}$      | feedback capacitance                | $V_{CE} = 26\ V$ ; $I_C = 0$ ; $f = 1\ MHz$       | –    | 2.5  | –    | pF   |

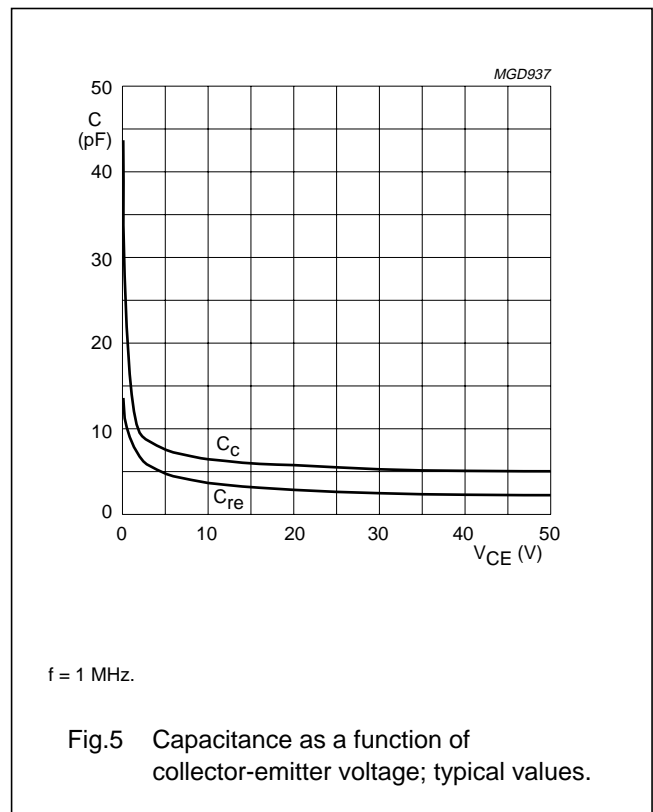
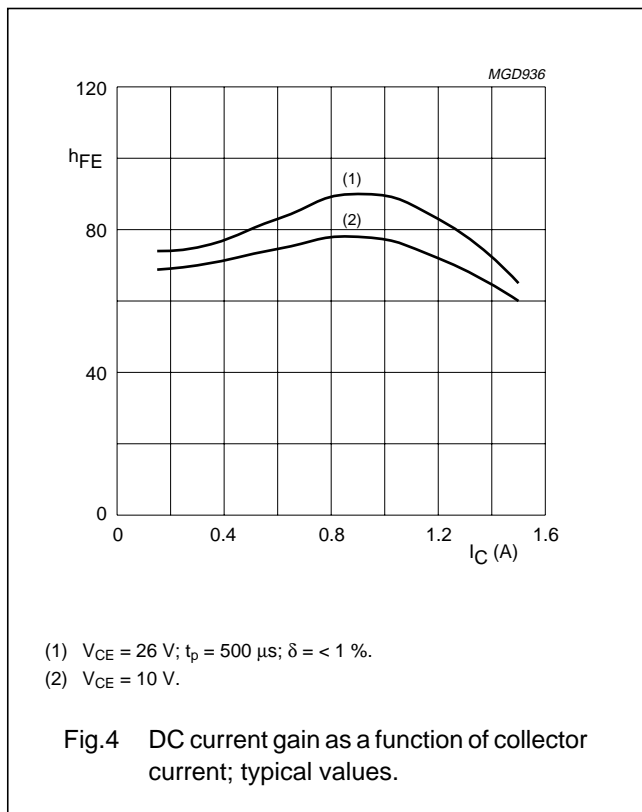

UHF power transistor

BLV904

APPLICATION INFORMATION

RF performance at  $T_{mb} = 25\text{ }^\circ\text{C}$  in a common emitter test circuit.

| MODE OF OPERATION | f (MHz)                  | V <sub>CE</sub> (V) | I <sub>CQ</sub> (mA) | P <sub>L</sub> (W) | G <sub>p</sub> (dB)    | $\eta_c$ (%)         | d <sub>im</sub> (dBc) |
|-------------------|--------------------------|---------------------|----------------------|--------------------|------------------------|----------------------|-----------------------|
| CW, class-AB      | 960                      | 26                  | 15                   | 5                  | $\geq 13$<br>typ. 15.5 | $\geq 50$<br>typ. 55 | –                     |
| 2-tone, class-AB  | $f_1 = 960; f_2 = 960.1$ | 26                  | 15                   | 5 (PEP)            | typ. 15.5              | typ. 40              | typ. -30              |

Ruggedness in class-AB operation

The BLV904 is capable of withstanding a load mismatch corresponding to VSWR = 20 : 1 through all phases under the following conditions: f = 960 MHz; V<sub>CE</sub> = 26 V; I<sub>CQ</sub> = 15 mA; P<sub>L</sub> = 5 W; T<sub>mb</sub> = 25 °C.

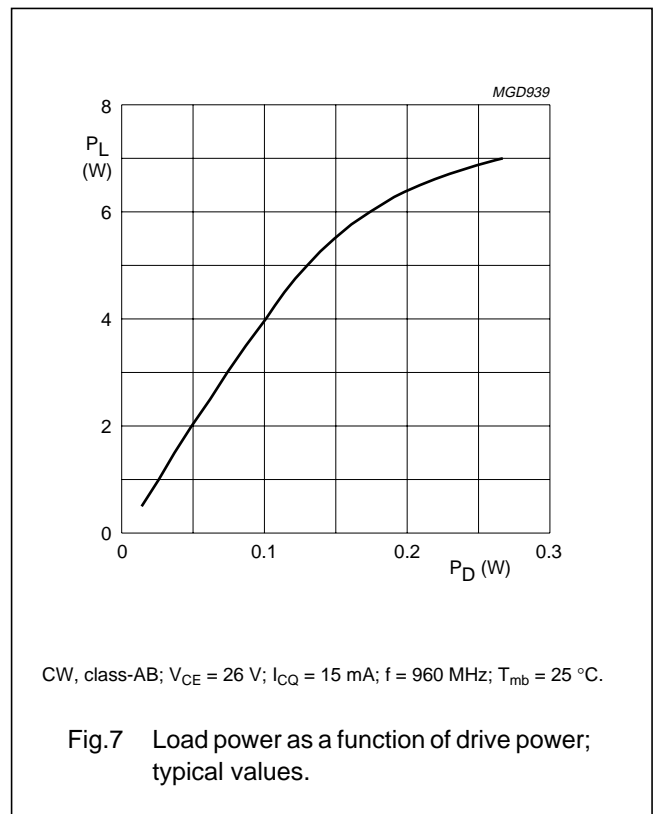
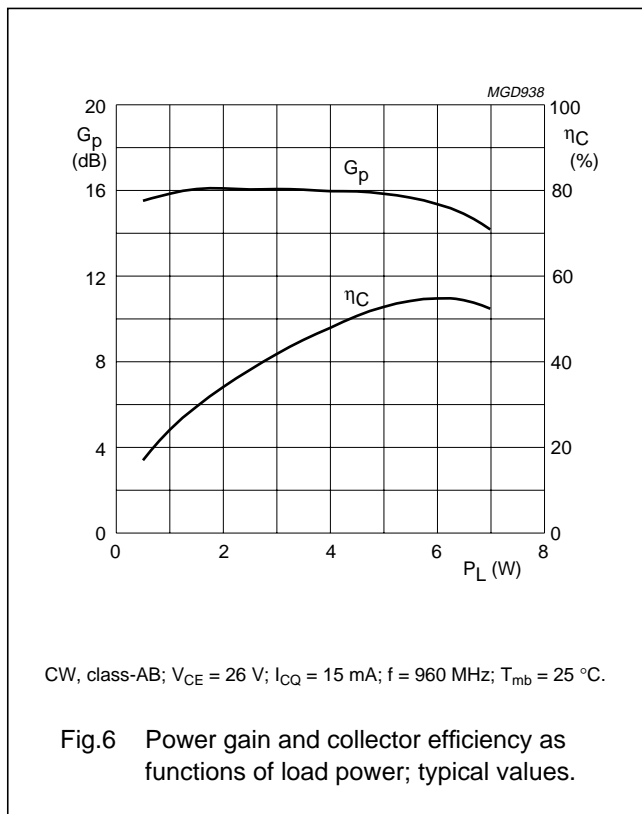

UHF power transistor

BLV904

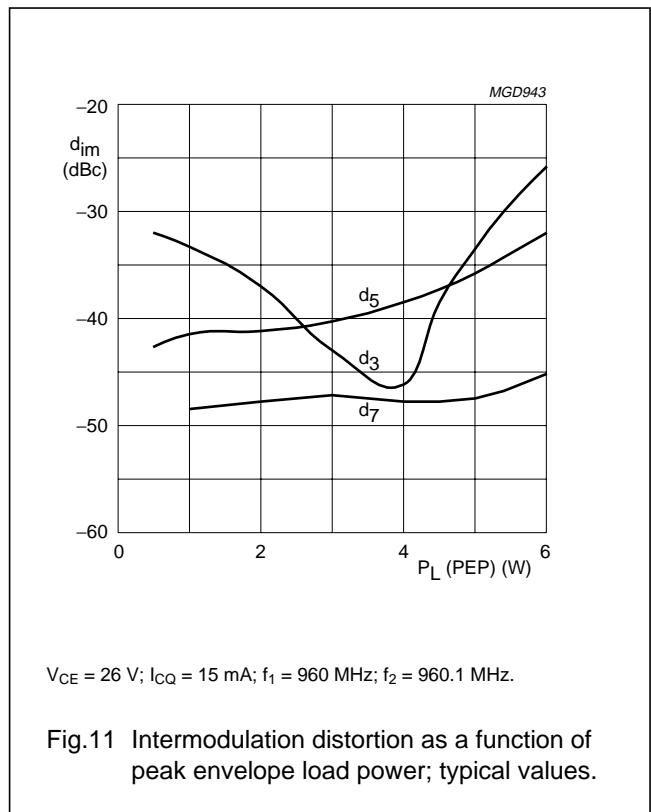
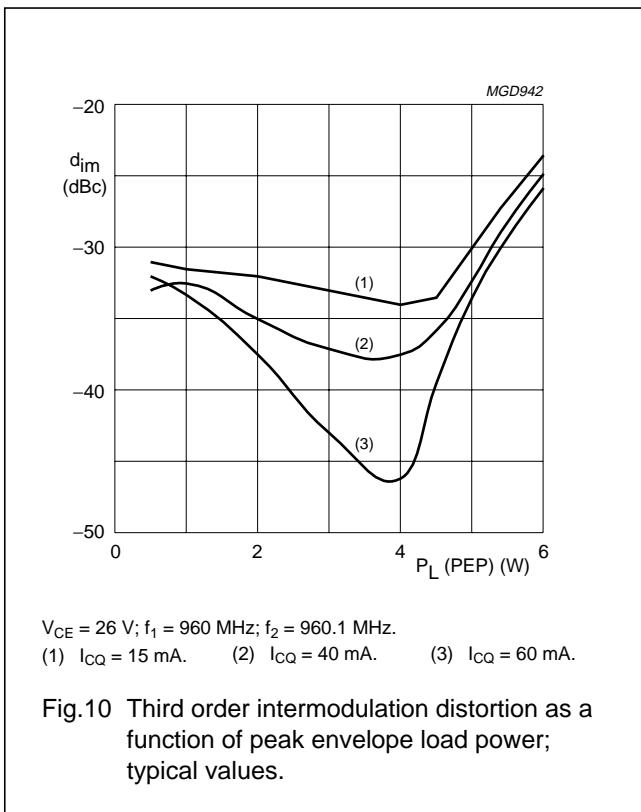
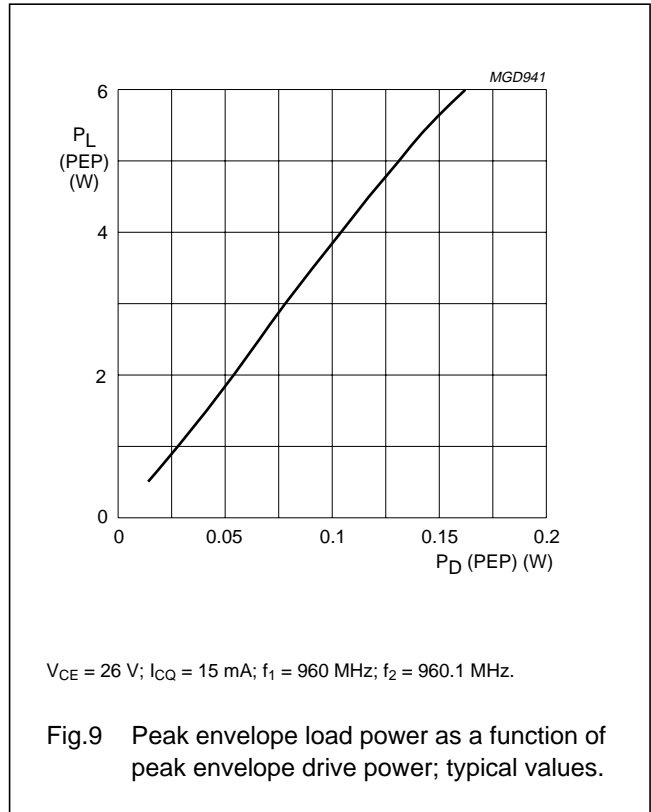
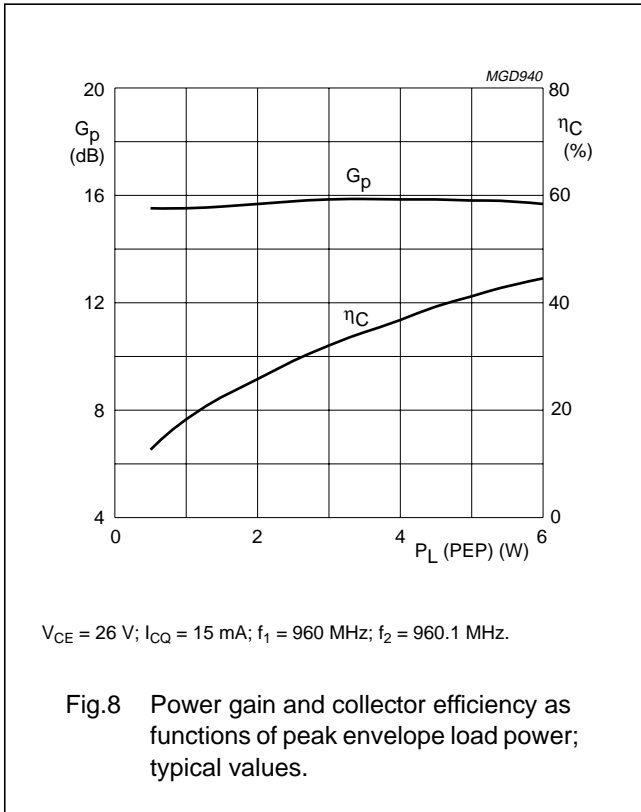

UHF power transistor

BLV904

Test circuit information

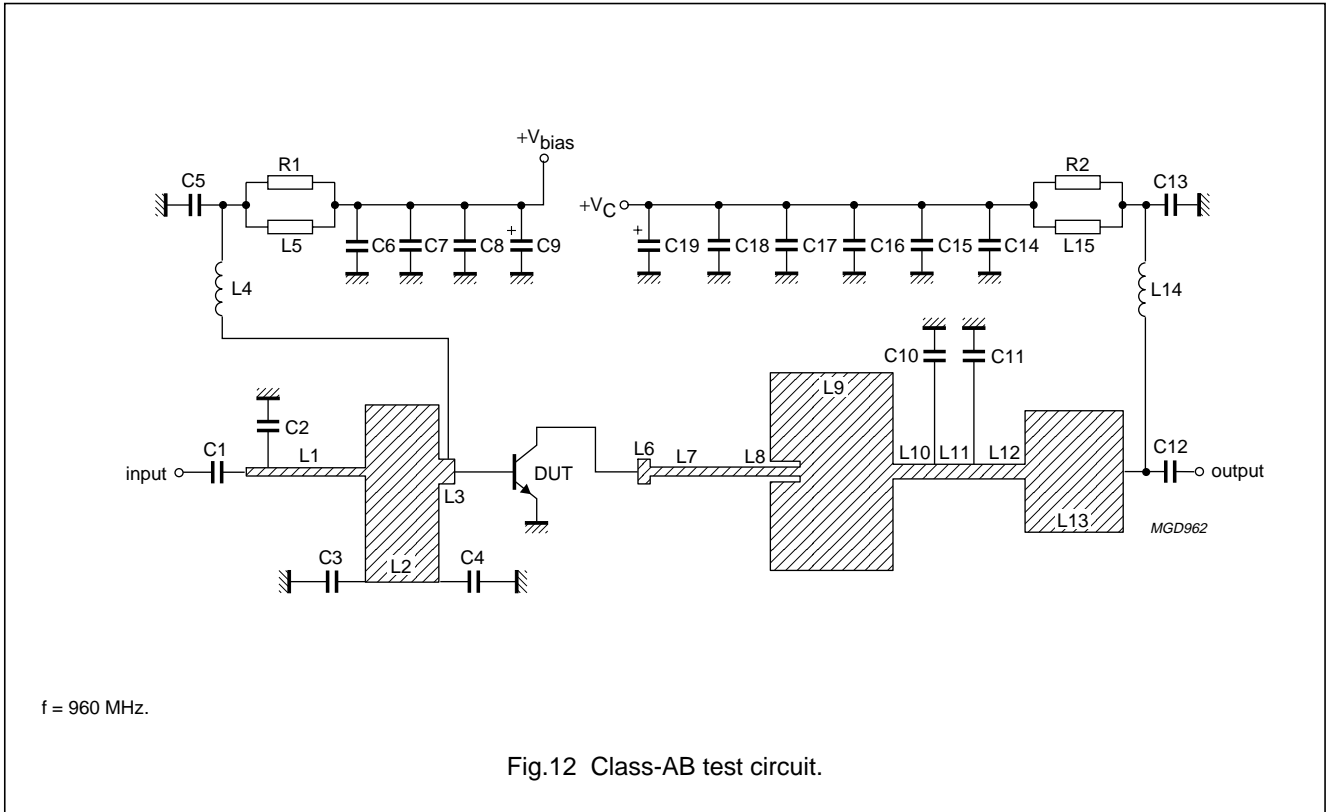

## UHF power transistor

BLV904

## List of components (see Figs 12 and 13)

| COMPONENT         | DESCRIPTION                               | VALUE                | DIMENSIONS            | CATALOGUE No.  |
|-------------------|---|----------------------|-----------------------|----------------|
| C1, C12           | multilayer ceramic chip capacitor; note 1 | 24 pF                |                       |                |
| C2                | multilayer ceramic chip capacitor; note 1 | 3.3 pF               |                       |                |
| C3                | multilayer ceramic chip capacitor; note 1 | 2.2 pF               |                       |                |
| C4                | multilayer ceramic chip capacitor; note 1 | 1.6 pF               |                       |                |
| C5, C6, C13, C18  | multilayer ceramic chip capacitor; note 2 | 200 pF               |                       |                |
| C7, C17           | multilayer ceramic chip capacitor; note 2 | 110 pF               |                       |                |
| C8, C14, C15, C16 | multilayer ceramic chip capacitor         | 100 nF               |                       | 2222 581 16641 |
| C9, C19           | tantalum SMD capacitor                    | 10 $\mu$ F; 35 V     |                       |                |
| C10               | multilayer ceramic chip capacitor; note 1 | 1.8 pF               |                       |                |
| C11               | multilayer ceramic chip capacitor; note 1 | 13 pF                |                       |                |
| L1                | stripline; note 3                         | 50 $\Omega$          | 8.2 $\times$ 0.65 mm  |                |
| L2                | stripline; note 3                         | 4.9 $\Omega$         | 6 $\times$ 14 mm      |                |
| L3, L6            | stripline; note 3                         | 24.5 $\Omega$        | 1.5 $\times$ 2 mm     |                |
| L4                | RF-choke                                  | 0.22 $\mu$ H         |                       |                |
| L5, L15           | grade 4S2 ferroxcube chip-bead            |                      |                       | 4330 030 36301 |
| L7                | stripline; note 3                         | 46.3 $\Omega$        | 12.22 $\times$ 0.7 mm |                |
| L8                | stripline; notes 3 and 4                  | 4.3 $\Omega$         | 7.58 $\times$ 16.1 mm |                |
| L9                | stripline; note 3                         | 4.3 $\Omega$         | 10 $\times$ 16.1 mm   |                |
| L10               | stripline; note 3                         | 34.3 $\Omega$        | 1.9 $\times$ 1.2 mm   |                |
| L11               | stripline; note 3                         | 34.3 $\Omega$        | 3.2 $\times$ 1.2 mm   |                |
| L12               | stripline; note 3                         | 34.3 $\Omega$        | 4.8 $\times$ 1.2 mm   |                |
| L13               | stripline; note 3                         | 6.7 $\Omega$         | 8 $\times$ 9.9 mm     |                |
| L14               | 5 turns enamelled 1 mm copper wire        |                      |                       |                |
| R1                | metal film resistor                       | 100 $\Omega$ ; 0.4 W |                       |                |
| DUT               | transistor                                | BLV904               |                       |                |

## Notes

1. American Technical Ceramics type 100A or capacitor of same quality.
2. American Technical Ceramics type 100B or capacitor of same quality.
3. The striplines are on a double copper-clad printed-circuit board with epoxy fibreglass dielectric ( $\epsilon_r = 10.2$ ); thickness 0.64 mm.
4. Not connected over total length; only 7.58 mm connected.



UHF power transistor

BLV904

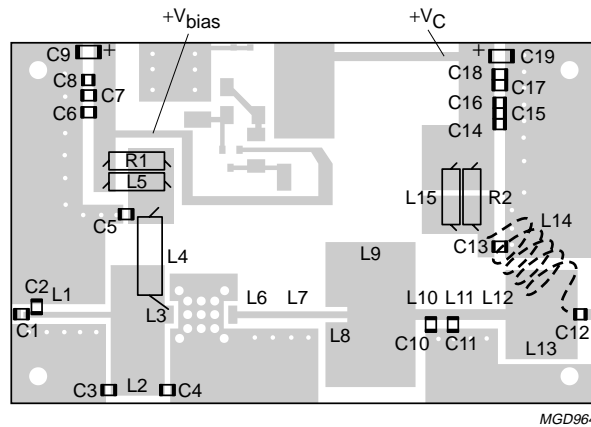

Dimensions in mm.

f = 960 MHz.

The components are situated on one side of the copper-clad epoxy fibreglass board, the other side is not etched and serves as a ground plane. Earth connections from the component side to the ground plane are made by through metallization.

Fig.13 Component layout for class-AB test circuit.

UHF power transistor

BLV904

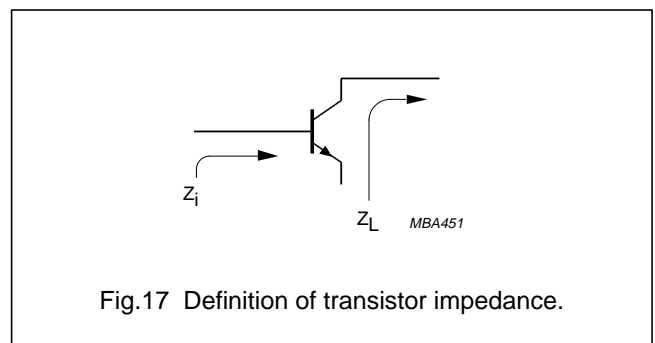
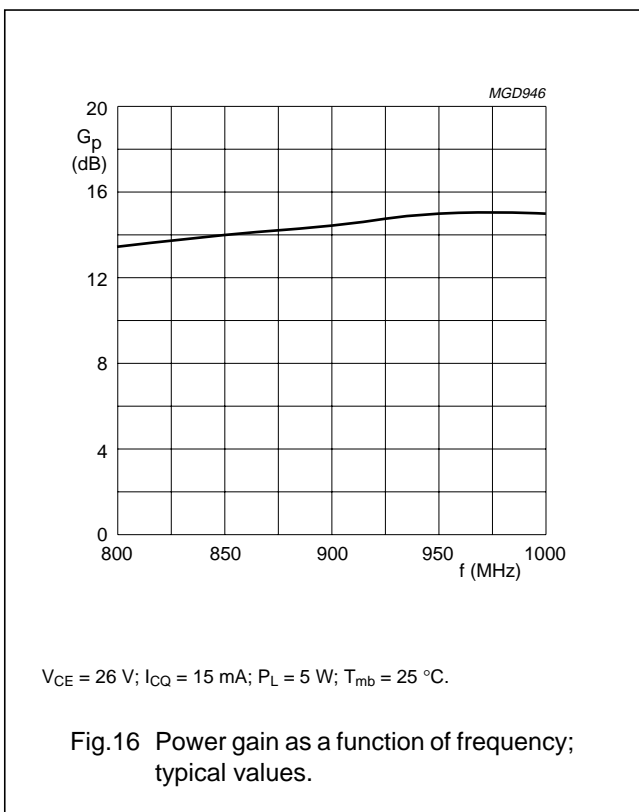
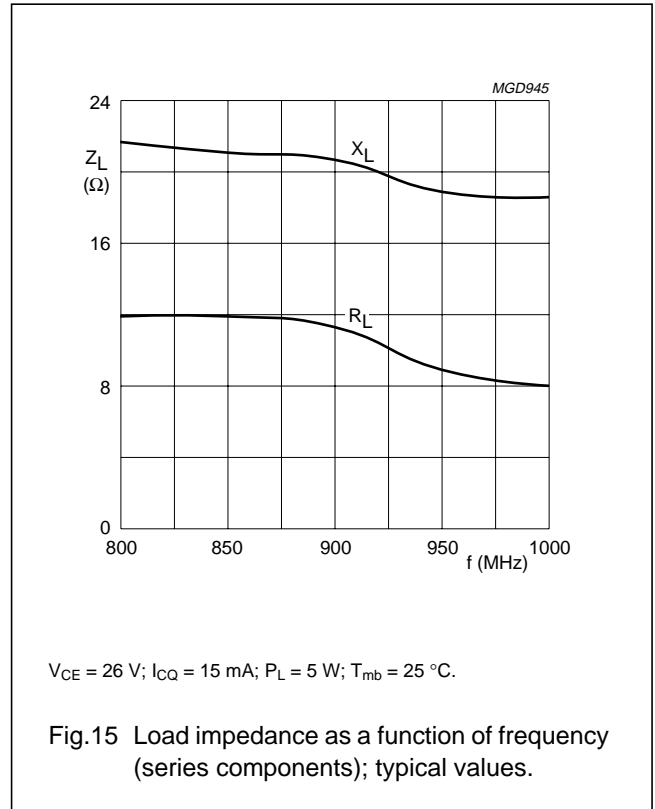
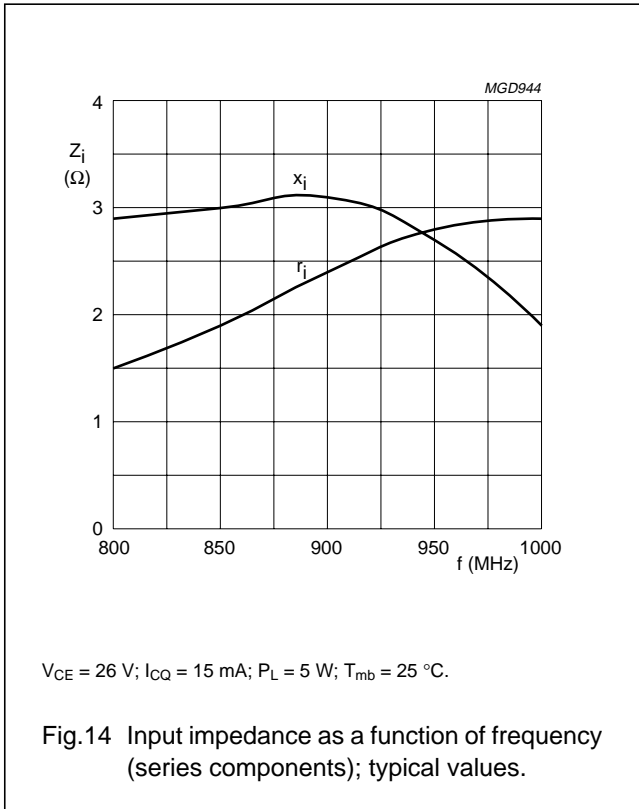

**MOUNTING RECOMMENDATIONS**

Heat from the device is transferred via the leads and the metallized underside. For optimum heat transfer it is recommended that the transistor be mounted on a grounded metallized area on the component side of the printed-circuit board. This metallized area should contain a large number of metallized, solder-filled through-holes. The non-component side of the printed-circuit board forms a ground plane. When the printed-circuit board is mounted on the heatsink using heatsink compound, a thermal resistance from mounting base to heatsink of 0.9 K/W can be attained.

UHF power transistor

BLV904

PACKAGE OUTLINE

Ceramic surface mounted package; 8 leads

SOT409B

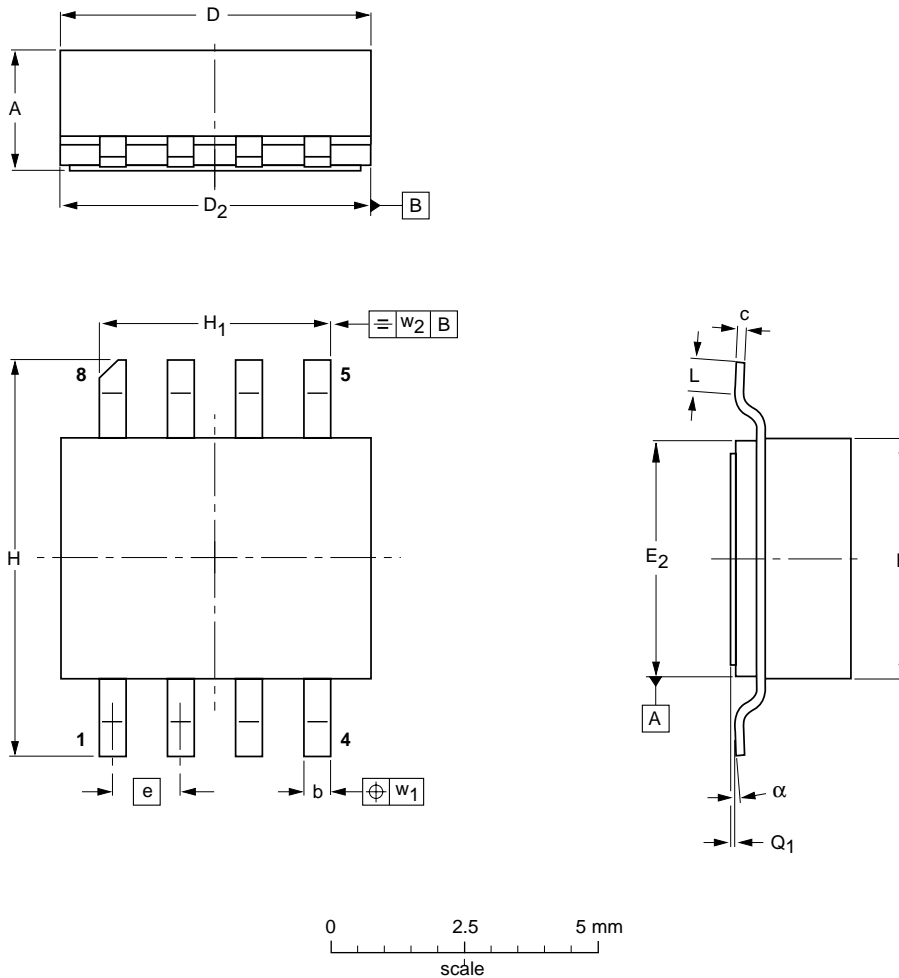

DIMENSIONS (millimetre dimensions are derived from the original inch dimensions)

| UNIT   | A              | b              | c              | D              | D <sub>2</sub> | E              | E <sub>2</sub> | e     | H              | H <sub>1</sub> | L              | Q <sub>1</sub> | w <sub>1</sub> | w <sub>2</sub> | α        |
|--------|----------------|----------------|----------------|----------------|----------------|----------------|----------------|-------|----------------|----------------|----------------|----------------|----------------|----------------|----------|
| mm     | 2.36<br>2.06   | 0.58<br>0.43   | 0.15<br>0.10   | 5.94<br>5.03   | 5.16<br>5.00   | 4.93<br>4.01   | 4.14<br>3.99   | 1.27  | 7.47<br>7.26   | 4.39<br>4.24   | 0.84<br>0.69   | 0.10<br>0.00   | 0.25           | 0.25           | 2°<br>0° |
| inches | 0.093<br>0.081 | 0.023<br>0.017 | 0.006<br>0.004 | 0.234<br>0.198 | 0.203<br>0.197 | 0.194<br>0.158 | 0.163<br>0.157 | 0.050 | 0.294<br>0.286 | 0.173<br>0.167 | 0.033<br>0.027 | 0.004<br>0.000 | 0.010          | 0.010          | 2°<br>0° |

| OUTLINE VERSION | REFERENCES |       |      |  | EUROPEAN PROJECTION | ISSUE DATE |
|-----------------|------------|-------|------|--|---------------------|------------|
|                 | IEC        | JEDEC | EIAJ |  |                     |            |
| SOT409B         |            |       |      |  |                     | 98-01-27   |

## UHF power transistor

BLV904

**DEFINITIONS**

|   |   |
|---|---|
| <b>Data Sheet Status</b>  |   |
| Objective specification   | This data sheet contains target or goal specifications for product development.       |
| Preliminary specification   | This data sheet contains preliminary data; supplementary data may be published later. |
| Product specification   | This data sheet contains final product specifications.                                |
| <b>Limiting values</b>  |   |
| Limiting values given are in accordance with the Absolute Maximum Rating System (IEC 134). Stress above one or more of the limiting values may cause permanent damage to the device. These are stress ratings only and operation of the device at these or at any other conditions above those given in the Characteristics sections of the specification is not implied. Exposure to limiting values for extended periods may affect device reliability. |   |
| <b>Application information</b>  |   |
| Where application information is given, it is advisory and does not form part of the specification.   |   |

**LIFE SUPPORT APPLICATIONS**

These products are not designed for use in life support appliances, devices, or systems where malfunction of these products can reasonably be expected to result in personal injury. Philips customers using or selling these products for use in such applications do so at their own risk and agree to fully indemnify Philips for any damages resulting from such improper use or sale.

UHF power transistor

BLV904

---

**NOTES**

UHF power transistor

BLV904

---

**NOTES**

UHF power transistor

BLV904

---

**NOTES**

# Philips Semiconductors – a worldwide company

**Argentina:** see South America

**Australia:** 34 Waterloo Road, NORTH RYDE, NSW 2113,  
Tel. +61 2 9805 4455, Fax. +61 2 9805 4466

**Austria:** Computerstr. 6, A-1101 WIEN, P.O. Box 213, Tel. +43 160 1010,  
Fax. +43 160 101 1210

**Belarus:** Hotel Minsk Business Center, Bld. 3, r. 1211, Volodarski Str. 6,  
220050 MINSK, Tel. +375 172 200 733, Fax. +375 172 200 773

**Belgium:** see The Netherlands

**Brazil:** see South America

**Bulgaria:** Philips Bulgaria Ltd., Energoproject, 15th floor,  
51 James Bourchier Blvd., 1407 SOFIA,  
Tel. +359 2 689 211, Fax. +359 2 689 102

**Canada:** PHILIPS SEMICONDUCTORS/COMPONENTS,  
Tel. +1 800 234 7381

**China/Hong Kong:** 501 Hong Kong Industrial Technology Centre,  
72 Tat Chee Avenue, Kowloon Tong, HONG KONG,  
Tel. +852 2319 7888, Fax. +852 2319 7700

**Colombia:** see South America

**Czech Republic:** see Austria

**Denmark:** Prags Boulevard 80, PB 1919, DK-2300 COPENHAGEN S,  
Tel. +45 32 88 2636, Fax. +45 31 57 0044

**Finland:** Sinikalliontie 3, FIN-02630 ESPOO,  
Tel. +358 9 615800, Fax. +358 9 61580920

**France:** 4 Rue du Port-aux-Vins, BP317, 92156 SURESNES Cedex,  
Tel. +33 1 40 99 6161, Fax. +33 1 40 99 6427

**Germany:** Hammerbrookstraße 69, D-20097 HAMBURG,  
Tel. +49 40 23 53 60, Fax. +49 40 23 536 300

**Greece:** No. 15, 25th March Street, GR 17778 TAVROS/ATHENS,  
Tel. +30 1 4894 339/239, Fax. +30 1 4814 240

**Hungary:** see Austria

**India:** Philips INDIA Ltd, Band Box Building, 2nd floor,  
254-D, Dr. Annie Besant Road, Worli, MUMBAI 400 025,  
Tel. +91 22 493 8541, Fax. +91 22 493 0966

**Indonesia:** see Singapore

**Ireland:** Newstead, Clonskeagh, DUBLIN 14,  
Tel. +353 1 7640 000, Fax. +353 1 7640 200

**Israel:** RAPAC Electronics, 7 Kehilat Saloniki St, PO Box 18053,  
TEL AVIV 61180, Tel. +972 3 645 0444, Fax. +972 3 649 1007

**Italy:** PHILIPS SEMICONDUCTORS, Piazza IV Novembre 3,  
20124 MILANO, Tel. +39 2 6752 2531, Fax. +39 2 6752 2557

**Japan:** Philips Bldg 13-37, Kohnan 2-chome, Minato-ku, TOKYO 108,  
Tel. +81 3 3740 5130, Fax. +81 3 3740 5077

**Korea:** Philips House, 260-199 Itaewon-dong, Yongsan-ku, SEOUL,  
Tel. +82 2 709 1412, Fax. +82 2 709 1415

**Malaysia:** No. 76 Jalan Universiti, 46200 PETALING JAYA, SELANGOR,  
Tel. +60 3 750 5214, Fax. +60 3 757 4880

**Mexico:** 5900 Gateway East, Suite 200, EL PASO, TEXAS 79905,  
Tel. +9-5 800 234 7381

**Middle East:** see Italy

**Netherlands:** Postbus 90050, 5600 PB EINDHOVEN, Bldg. VB,  
Tel. +31 40 27 82785, Fax. +31 40 27 88399

**New Zealand:** 2 Wagener Place, C.P.O. Box 1041, AUCKLAND,  
Tel. +64 9 849 4160, Fax. +64 9 849 7811

**Norway:** Box 1, Manglerud 0612, OSLO,  
Tel. +47 22 74 8000, Fax. +47 22 74 8341

**Philippines:** Philips Semiconductors Philippines Inc.,  
106 Valero St. Salcedo Village, P.O. Box 2108 MCC, MAKATI,  
Metro MANILA, Tel. +63 2 816 6380, Fax. +63 2 817 3474

**Poland:** Ul. Lukiska 10, PL 04-123 WARSZAWA,  
Tel. +48 22 612 2831, Fax. +48 22 612 2327

**Portugal:** see Spain

**Romania:** see Italy

**Russia:** Philips Russia, Ul. Usatcheva 35A, 119048 MOSCOW,  
Tel. +7 095 755 6918, Fax. +7 095 755 6919

**Singapore:** Lorong 1, Toa Payoh, SINGAPORE 1231,  
Tel. +65 350 2538, Fax. +65 251 6500

**Slovakia:** see Austria

**Slovenia:** see Italy

**South Africa:** S.A. PHILIPS Pty Ltd., 195-215 Main Road Martindale,  
2092 JOHANNESBURG, P.O. Box 7430 Johannesburg 2000,  
Tel. +27 11 470 5911, Fax. +27 11 470 5494

**South America:** Rua do Rocio 220, 5th floor, Suite 51,  
04552-903 São Paulo, SÃO PAULO - SP, Brazil,  
Tel. +55 11 821 2333, Fax. +55 11 829 1849

**Spain:** Balmes 22, 08007 BARCELONA,  
Tel. +34 3 301 6312, Fax. +34 3 301 4107

**Sweden:** Kottbygatan 7, Akalla, S-16485 STOCKHOLM,  
Tel. +46 8 632 2000, Fax. +46 8 632 2745

**Switzerland:** Allmendstrasse 140, CH-8027 ZÜRICH,  
Tel. +41 1 488 2686, Fax. +41 1 481 7730

**Taiwan:** Philips Semiconductors, 6F, No. 96, Chien Kuo N. Rd., Sec. 1,  
TAIPEI, Taiwan Tel. +886 2 2134 2865, Fax. +886 2 2134 2874

**Thailand:** PHILIPS ELECTRONICS (THAILAND) Ltd.,  
209/2 Sanpavuth-Bangna Road Prakanong, BANGKOK 10260,  
Tel. +66 2 745 4090, Fax. +66 2 398 0793

**Turkey:** Talatpasa Cad. No. 5, 80640 GÜLTEPE/ISTANBUL,  
Tel. +90 212 279 2770, Fax. +90 212 282 6707

**Ukraine:** PHILIPS UKRAINE, 4 Patrice Lumumba str., Building B, Floor 7,  
252042 KIEV, Tel. +380 44 264 2776, Fax. +380 44 268 0461

**United Kingdom:** Philips Semiconductors Ltd., 276 Bath Road, Hayes,  
MIDDLESEX UB3 5BX, Tel. +44 181 730 5000, Fax. +44 181 754 8421

**United States:** 811 East Arques Avenue, SUNNYVALE, CA 94088-3409,  
Tel. +1 800 234 7381

**Uruguay:** see South America

**Vietnam:** see Singapore

**Yugoslavia:** PHILIPS, Trg N. Pasica 5/v, 11000 BEOGRAD,  
Tel. +381 11 625 344, Fax. +381 11 635 777

**For all other countries apply to:** Philips Semiconductors, Marketing & Sales Communications,  
Building BE-p, P.O. Box 218, 5600 MD EINDHOVEN, The Netherlands, Fax. +31 40 27 24825

**Internet:** <http://www.semiconductors.philips.com>

© Philips Electronics N.V. 1997

SCA55

All rights are reserved. Reproduction in whole or in part is prohibited without the prior written consent of the copyright owner.

The information presented in this document does not form part of any quotation or contract, is believed to be accurate and reliable and may be changed without notice. No liability will be accepted by the publisher for any consequence of its use. Publication thereof does not convey nor imply any license under patent- or other industrial or intellectual property rights.

Printed in The Netherlands

127067/00/02/pp16

Date of release: 1997 Jul 15

Document order number: 9397 750 02545

*Let's make things better.*

Philips



PHILIPS