

**DISCRETE SEMICONDUCTORS**

# DATA SHEET

## **BLV99/SL** UHF power transistor

Product specification

September 1991

# UHF power transistor

# BLV99/SL

### FEATURES

- Emitter-ballasting resistors for an optimum temperature profile
- Gold metallization ensures excellent reliability.

### DESCRIPTION

NPN silicon planar epitaxial transistor encapsulated in a 4-lead SOT172D envelope with a ceramic cap. It is designed primarily for use as a driver stage in base stations in the 900 MHz communications band. All leads are isolated from the mounting base.

### PINNING - SOT172D

PIN	DESCRIPTION
1	emitter
2	base
3	collector
4	emitter

### PIN CONFIGURATION

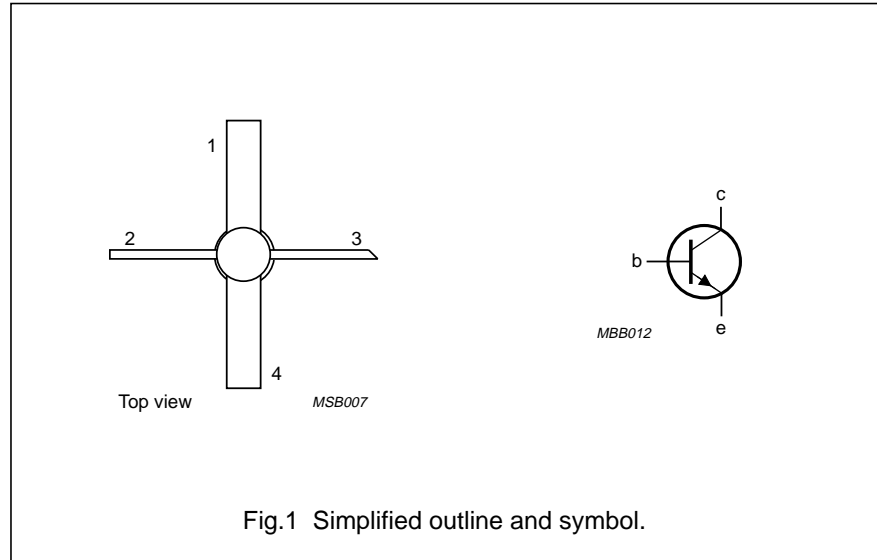

Fig.1 Simplified outline and symbol.

### WARNING

#### Product and environmental safety - toxic materials

This product contains beryllium oxide. The product is entirely safe provided that the BeO disc is not damaged. All persons who handle, use or dispose of this product should be aware of its nature and of the necessary safety precautions. After use, dispose of as chemical or special waste according to the regulations applying at the location of the user. It must never be thrown out with the general or domestic waste.

### QUICK REFERENCE DATA

RF performance at  $T_{mb} = 25\text{ }^{\circ}\text{C}$  in a common emitter class-B test circuit.

MODE OF OPERATION	f (MHz)	V <sub>CE</sub> (V)	P <sub>L</sub> (W)	G <sub>p</sub> (dB)	$\eta_c$ (%)
c.w. narrow band	900	24	2	> 8	> 55

## UHF power transistor

BLV99/SL

## LIMITING VALUES

In accordance with the Absolute Maximum System (IEC 134).

SYMBOL	PARAMETER	CONDITIONS	MIN.	MAX.	UNIT
$V_{CBO}$	collector-base voltage	open emitter	–	50	V
$V_{CEO}$	collector-emitter voltage	open base	–	27	V
$V_{EBO}$	emitter-base voltage	open collector	–	3.5	V
$I_C$	collector current	DC value	–	200	mA
$I_{CM}$	collector current	peak value $f > 1$ MHz	–	600	mA
$P_{tot}$	total power dissipation	$f > 1$ MHz; $T_{mb} = 50$ °C	–	6	W
$T_{stg}$	storage temperature range		–65	150	°C
$T_j$	junction operating temperature		–	200	°C

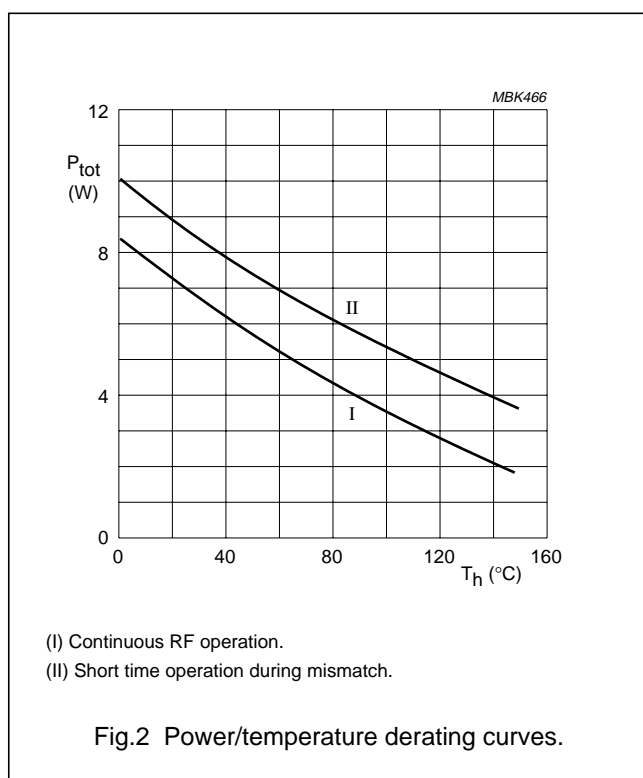

## THERMAL RESISTANCE

SYMBOL	PARAMETER	CONDITIONS	MAX.	UNIT
$R_{th\ j-mb(RF)}$	from junction to mounting base	$P_L = 4.5$ W; $T_{mb} = 25$ °C	20	K/W

UHF power transistor

BLV99/SL

CHARACTERISTICS

T<sub>j</sub> = 25 °C.

SYMBOL	PARAMETER	CONDITIONS	MIN.	TYP.	MAX.	UNIT
V <sub>(BR)CBO</sub>	collector-base breakdown voltage	open emitter; I <sub>C</sub> = 5 mA	50	–	–	V
V <sub>(BR)CEO</sub>	collector-emitter breakdown voltage	V <sub>BE</sub> = 0; I <sub>C</sub> = 10 mA	27	–	–	V
V <sub>(BR)EBO</sub>	emitter-base breakdown voltage	open collector; I <sub>E</sub> = 0.5 mA	3.5	–	–	V
I <sub>CES</sub>	collector-emitter leakage current	V <sub>BE</sub> = 0; V <sub>CE</sub> = 27 V	–	–	2	mA
h <sub>FE</sub>	DC current gain	V <sub>CE</sub> = 20 V; I <sub>C</sub> = 150 mA	25	–	–	
E <sub>SBR</sub>	second breakdown energy	L = 25 mH; R <sub>BE</sub> = 10 Ω; f = 50 Hz	0.5	–	–	mJ
C <sub>c</sub>	collector capacitance	V <sub>CB</sub> = 24 V; I <sub>E</sub> = I <sub>e</sub> = 0; f = 1 MHz	–	3	–	pF
C <sub>re</sub>	feedback capacitance	V <sub>CE</sub> = 24 V; I <sub>C</sub> = 0; f = 1 MHz	–	1.3	–	pF

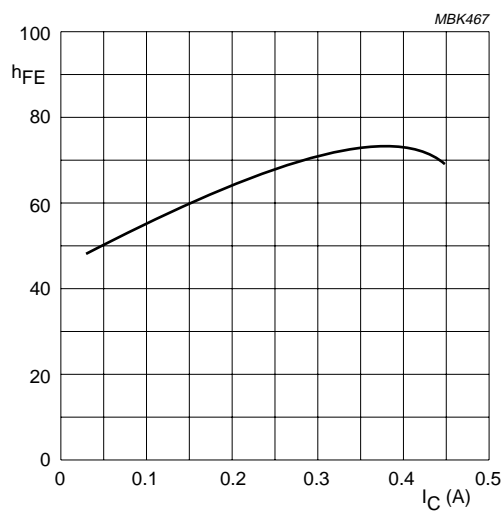

V<sub>CE</sub> = 20 V; T<sub>j</sub> = 25 °C.

Fig.3 DC current gain as a function of collector current, typical values.

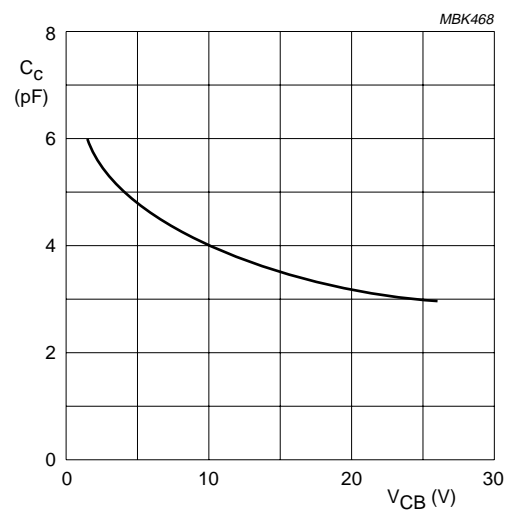

I<sub>E</sub> = I<sub>e</sub> = 0; f = 1 MHz.

Fig.4 Collector capacitance as a function of collector-base voltage, typical values.

UHF power transistor

BLV99/SL

APPLICATION INFORMATION

RF performance  $T_{mb} = 25\text{ }^{\circ}\text{C}$  in a common emitter class-B test circuit.

MODE OF OPERATION	f (MHz)	$V_{CE}$ (V)	$P_L$ (W)	$G_p$ (dB)	$\eta_c$ (%)
c.w. narrow band	900	24	2	> 8 typ. 9.3	> 55 typ. 63

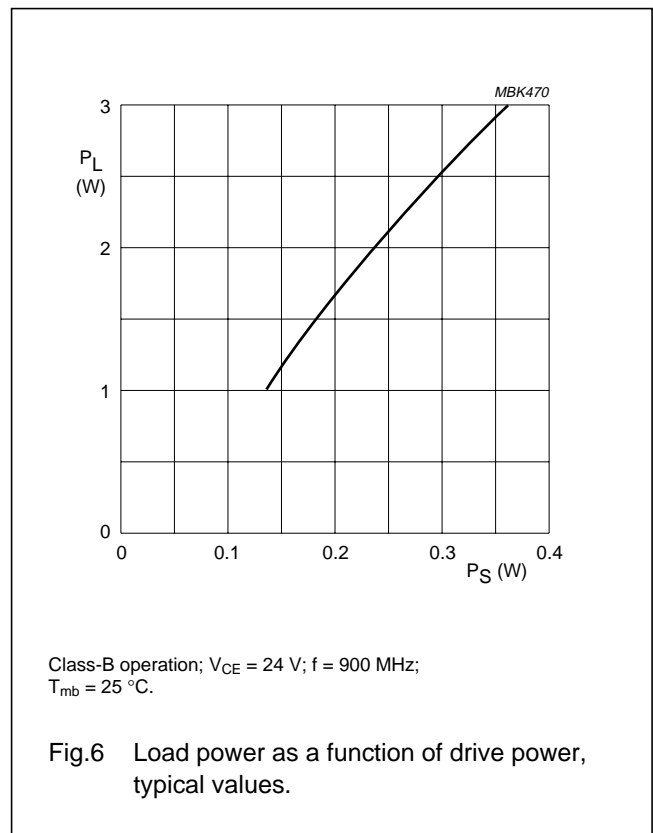
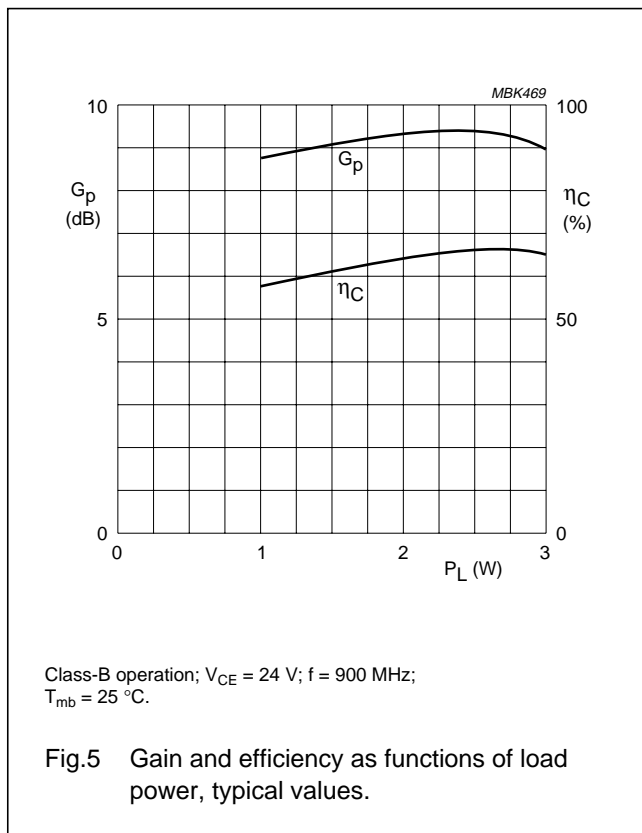

Ruggedness in class-B operation

The BLV99/SL is capable of withstanding a full load mismatch corresponding to  $VSWR = 50:1$  through all phases under the following conditions:

$V_{CE} = 24\text{ V}$ ,  $f = 900\text{ MHz}$ ,  
 $T_{mb} = 25\text{ }^{\circ}\text{C}$ , and rated output power.

UHF power transistor

BLV99/SL

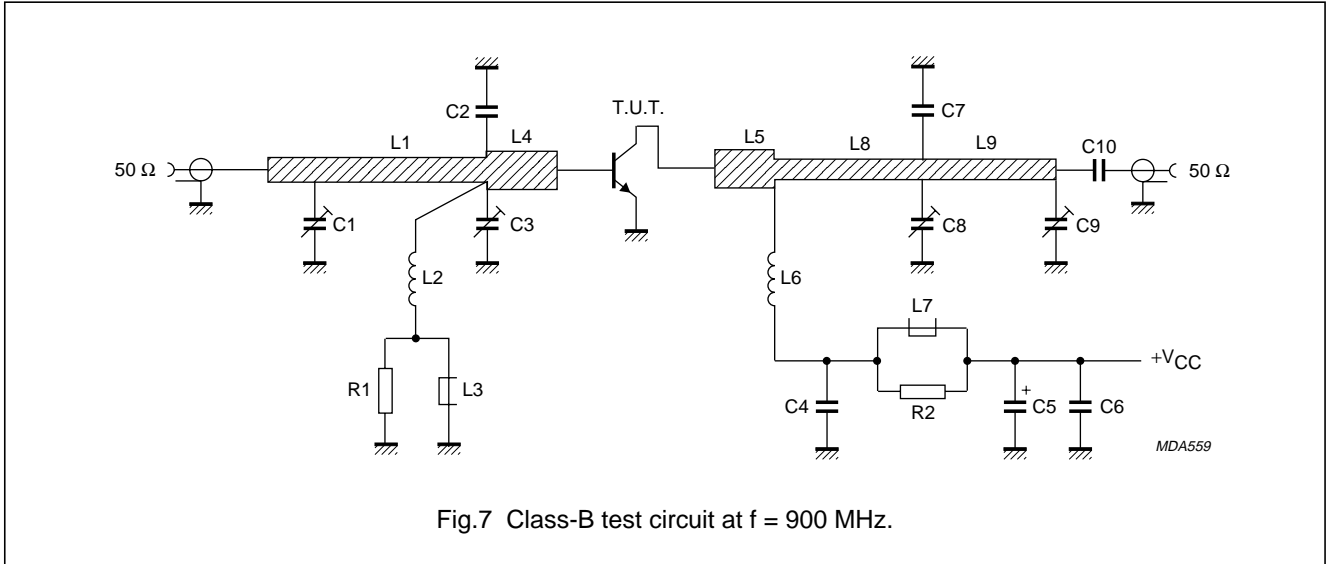

List of components (see test circuit)

COMPONENT	DESCRIPTION	VALUE	DIMENSIONS	CATALOGUE NO.
C1, C3, C8, C9	film dielectric trimmer	1.4 to 5.5 pF		2222 809 09001
C2	multilayer ceramic chip capacitor (note 1)	4.7 pF		
C4, C6, C10	multilayer ceramic chip capacitor	220 pF		
C5	63 V electrolytic capacitor	1 μF		
C7	multilayer ceramic chip capacitor (note 1)	2.2 pF		
L1	stripline (note 2)	50 Ω	48 mm × 2.4 mm	
L2	7 turns enamelled 0.4 mm copper wire	50 nH	int. dia. 2 mm; leads 2 × 5 mm	
L3, L7	grade 3B Ferroxcube wideband HF choke			4312 020 36642
L4, L5	stripline (note 2)	35 Ω	14 mm × 4 mm;	
L6	6 turns enamelled 1 mm copper wire	120 nH	int. dia. 6 mm; length 10 mm; leads 2 × 5 mm	
L8	stripline (note 2)	50 Ω	31 mm × 2.4 mm	
L9	stripline (note 2)	50 Ω	29 mm × 2.4 mm	
R1, R2	0.4 W metal film resistor	10 Ω, 5%		

Notes

1. American Technical Ceramics type 100A or capacitor of the same quality.
2. The striplines are on a double copper-clad printed circuit board, with PTFE fibre-glass dielectric ( $\epsilon_r = 2.2$ ), thickness  $\frac{1}{32}$  inch.

UHF power transistor

BLV99/SL

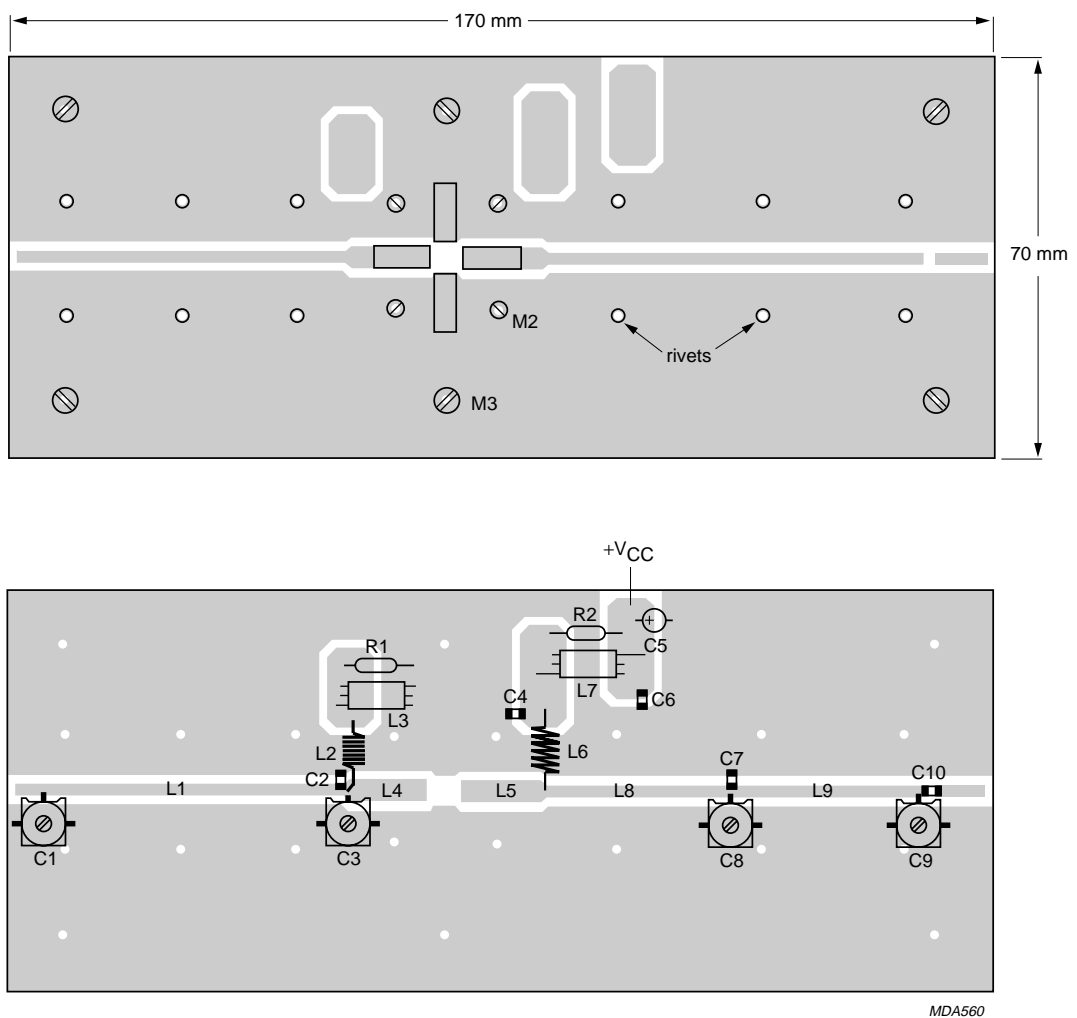

The components are mounted on one side of a copper clad PTFE fibre-glass board; the other side is unetched and serves as a ground plane. Earth connections from the component side to the ground plane are made by fixing screws, hollow rivets and copper straps under the emitters.

Fig.8 Component layout for 900 MHz class-B test circuit.

UHF power transistor

BLV99/SL

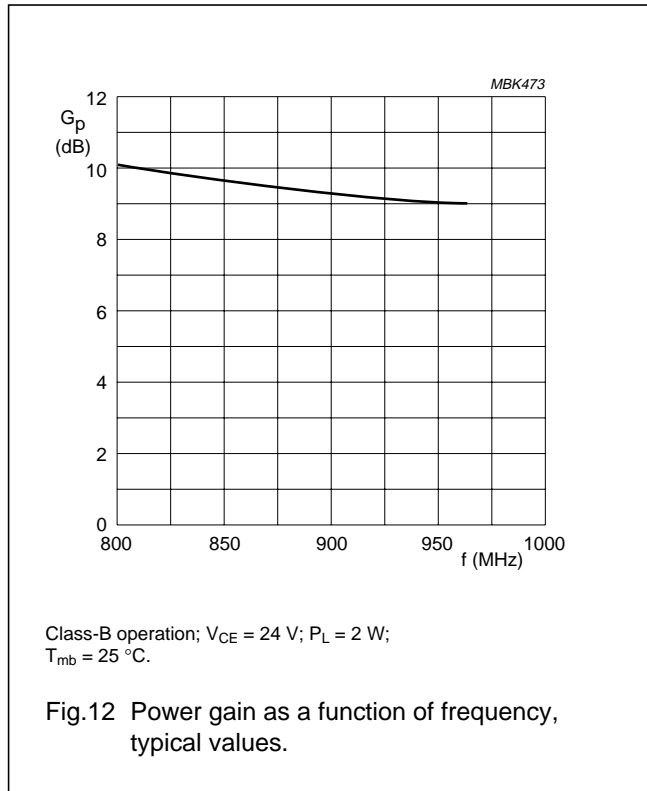
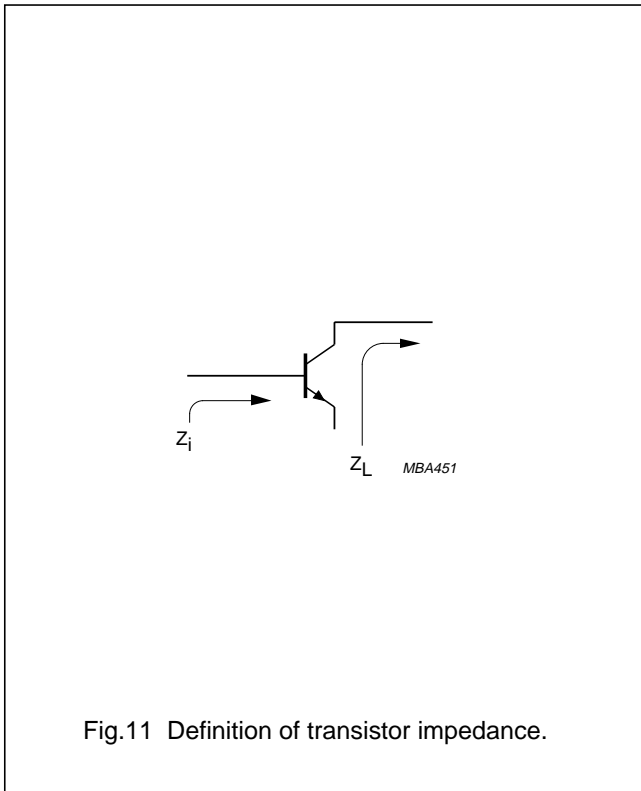
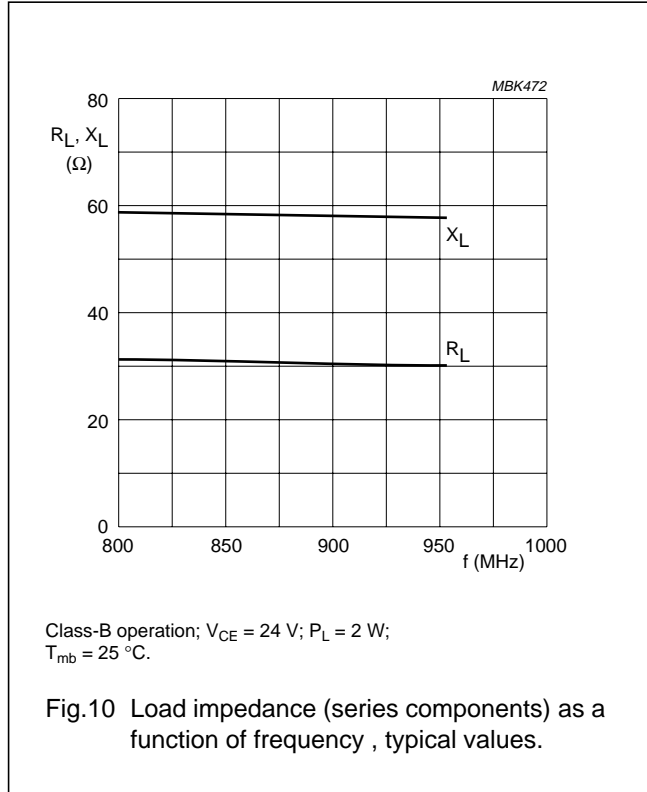
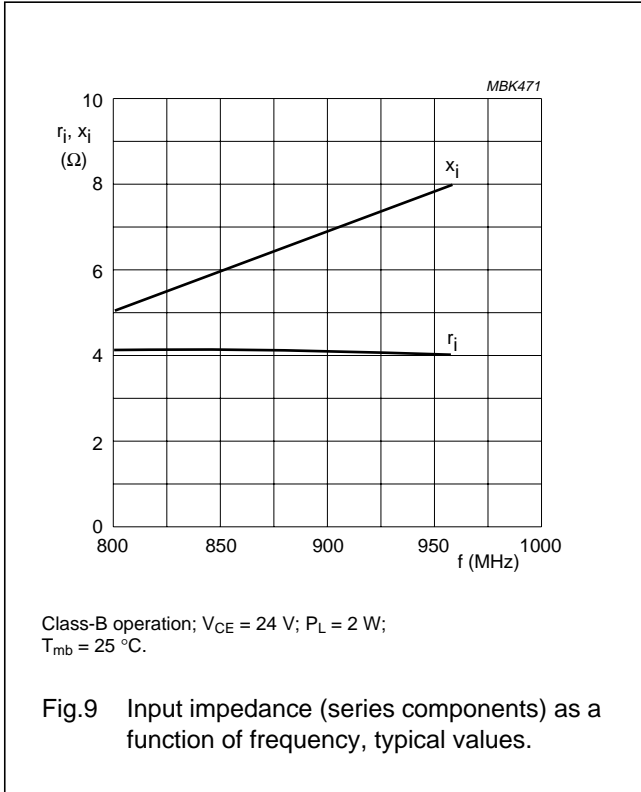



UHF power transistor

BLV99/SL

PACKAGE OUTLINE

Studless ceramic package; 4 leads

SOT172D

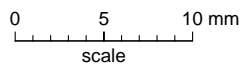
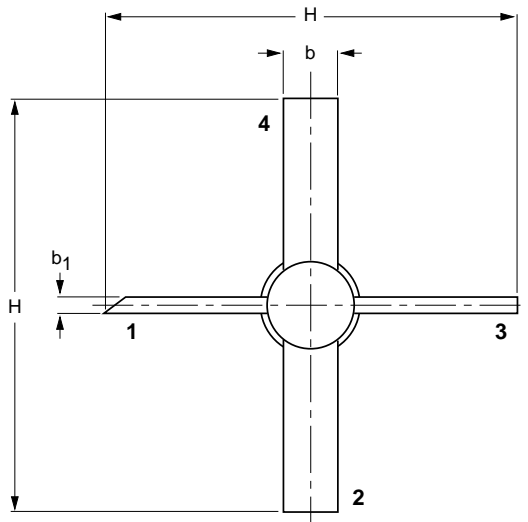
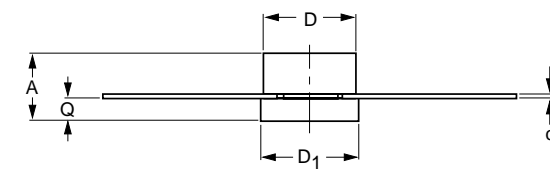

DIMENSIONS (millimetre dimensions are derived from the original inch dimensions)

UNIT	A	b	b <sub>1</sub>	c	D	D <sub>1</sub>	H	Q
mm	3.71 2.89	3.31 3.04	0.89 0.63	0.16 0.10	5.20 4.95	5.33 5.08	26.17 24.63	1.15 0.88
inches	0.146 0.114	0.13 0.12	0.035 0.025	0.006 0.004	0.205 0.195	0.210 0.200	1.03 0.97	0.045 0.035

OUTLINE VERSION	REFERENCES				EUROPEAN PROJECTION	ISSUE DATE
	IEC	JEDEC	EIAJ			
SOT172D						97-06-28

## UHF power transistor

BLV99/SL

**DEFINITIONS**

<b>Data Sheet Status</b>	
Objective specification	This data sheet contains target or goal specifications for product development.
Preliminary specification	This data sheet contains preliminary data; supplementary data may be published later.
Product specification	This data sheet contains final product specifications.
<b>Limiting values</b>	
Limiting values given are in accordance with the Absolute Maximum Rating System (IEC 134). Stress above one or more of the limiting values may cause permanent damage to the device. These are stress ratings only and operation of the device at these or at any other conditions above those given in the Characteristics sections of the specification is not implied. Exposure to limiting values for extended periods may affect device reliability.	
<b>Application information</b>	
Where application information is given, it is advisory and does not form part of the specification.	

**LIFE SUPPORT APPLICATIONS**

These products are not designed for use in life support appliances, devices, or systems where malfunction of these products can reasonably be expected to result in personal injury. Philips customers using or selling these products for use in such applications do so at their own risk and agree to fully indemnify Philips for any damages resulting from such improper use or sale.