

VOLTAGE REGULATOR WITH ON/OFF SWITCH

FEATURES

- High Voltage Precision at $\pm 2.0\%$
- Active High On/Off Control
- Very Low Dropout Voltage 80 mV at 30 mA
- Very Low Noise
- Very Small SOT-23L or SOT-89 Surface Mount Packages
- Internal Thermal Shutdown
- Short Circuit Protection

DESCRIPTION

The TK112xxB is a low dropout linear regulator with a built-in electronic switch. The internal switch can be controlled by TTL or CMOS logic levels. The device is in the "on" state when the control pin is pulled to a logic high level. An external capacitor can be connected to the noise bypass pin to lower the output noise level to 30 μ Vrms.

An internal PNP pass transistor is used to achieve a low dropout voltage of 80 mV (typ.) at 30 mA load current. The TK112xxB has a very low quiescent current of 170 μ A at no load and 1 mA with a 30 mA load. The standby current is typically 100 nA. The internal thermal shut down circuitry limits the junction temperature to below 150 °C. The load current is internally monitored and the device will shut down in the presence of a short circuit or overcurrent condition at the output.

APPLICATIONS

- Battery Powered Systems
- Cellular Telephones
- Pagers
- Personal Communications Equipment
- Portable Instrumentation
- Portable Consumer Equipment
- Radio Control Systems
- Toys
- Low Voltage Systems

The TK112xxB is available in either a 6-pin SOT-23L or a 5-pin SOT-89 surface mount package.

ORDERING INFORMATION

TK112 **B**

Voltage Code

Package Code

Tape/Reel Code

Temp. Code

VOLTAGE CODE 13 = 1.3 V 33 = 3.3 V 14 = 1.4 V 34 = 3.4 V 15 = 1.5 V 35 = 3.5 V 16 = 1.6 V 36 = 3.6 V 17 = 1.7 V 37 = 3.7 V 18 = 1.8 V 38 = 3.8 V 19 = 1.9 V 39 = 3.9 V 20 = 2.0 V 40 = 4.0 V 21 = 2.1 V 41 = 4.1 V 22 = 2.2 V 42 = 4.2 V 23 = 2.3 V 43 = 4.3 V 24 = 2.4 V 44 = 4.4 V 25 = 2.5 V 45 = 4.5 V 26 = 2.6 V 46 = 4.6 V 27 = 2.7 V 47 = 4.7 V 28 = 2.8 V 48 = 4.8 V 29 = 2.9 V 49 = 4.9 V 30 = 3.0 V 50 = 5.0 V 31 = 3.1 V 55 = 5.5 V 32 = 3.2 V 80 = 8.0 V	PACKAGE CODE: M: SOT-23L U: SOT-89 NOTE 1: 1.3 V to 1.9 V available in SOT-23L package only. NOTE 2: 1.3 V to 2.4 V available in C temperature code (-30 to +80 °C) only.	TAPE/REEL CODE L: Tape Left (SOT-23L) B: Tape Left (SOT-89) TEMP. CODE: C: -30 to +80 °C I: -40 to +85 °C
---	---	--

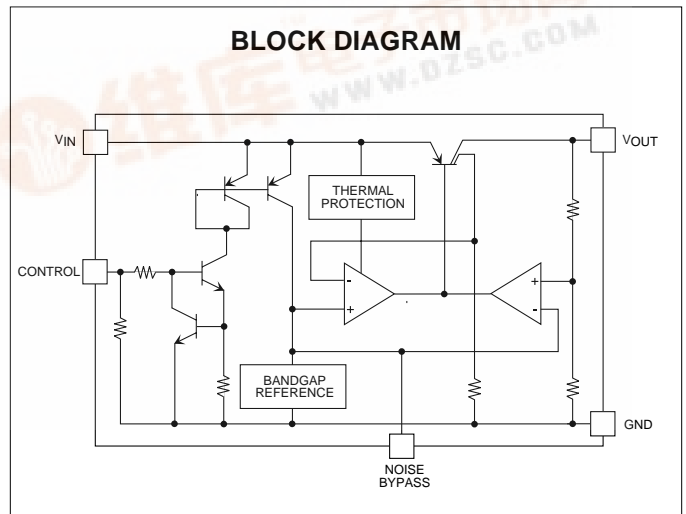
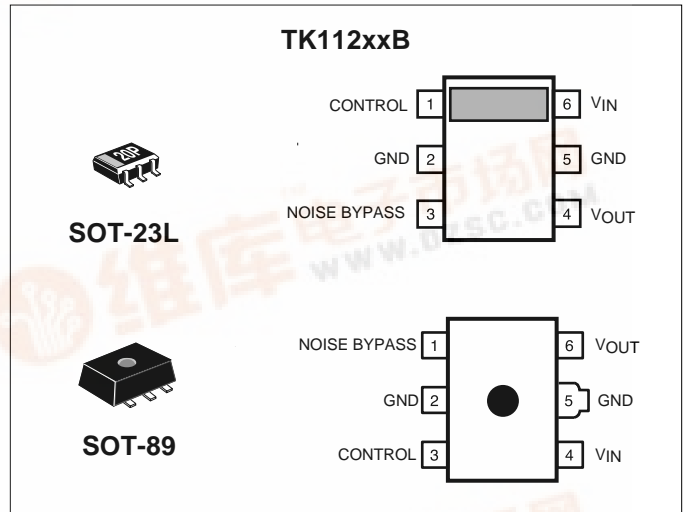

TK112xxB

ABSOLUTE MAXIMUM RATINGS TK112xxBC ($V_{OUT} \geq 2.0 V$)

Supply Voltage	16 V	Storage Temperature Range	-55 to +150 °C
Power Dissipation SOT-23L (Note1)	600 mW	Operating Temperature Range	-30 to +80 °C
Power Dissipation SOT-89 (Note1)	900 mW	Operating Voltage Range	1.8 to 14.5 V
Reverse Bias	10 V	Junction Temperature	150 °C

TK112xxBC ELECTRICAL CHARACTERISTICS ($V_{OUT} \geq 2.0 V$)

Test conditions: $T_A = 25\text{ °C}$, unless otherwise specified.

SYMBOL	PARAMETER	TEST CONDITIONS	MIN	TYP	MAX	UNITS
I_Q	Quiescent Current	$I_{OUT} = 0\text{ mA}$, Excluding I_{CONT}		170	250	μA
I_{STBY}	Standby Current	$V_{IN} = 8\text{ V}$, Output OFF			0.1	μA
V_{OUT}	Output Voltage	$I_{OUT} = 30\text{ mA}$	See Table 1			V
Line Reg	Line Regulation	$V_{OUT} \leq 5.5\text{ V}$, (Note 2)		3.0	20	mV
		$V_{OUT} \geq 5.6\text{ V}$, (Note 2)		15	40	mV
Load Reg	Load Regulation	$I_{OUT} = 1\text{ to }60\text{ mA}$, (Note 2)		6	30	mV
		$I_{OUT} = 1\text{ to }100\text{ mA}$, (Note 2)		18	60	mV
		$I_{OUT} = 1\text{ to }150\text{ mA}$, (Note 2)		23	90	mV
V_{DROP}	Dropout Voltage	$I_{OUT} = 60\text{ mA}$, (Note 2)		0.12	0.20	V
		$I_{OUT} = 150\text{ mA}$, (Note 2)		0.26	0.39	V
I_{OUT}	Continuous Output Current	(Note 2)			150	mA
$I_{OUT(PULSE)}$	Pulse Output Current	5 ms pulse, 12.5 % duty cycle			180	mA
RR	Ripple Rejection	$f = 400\text{ Hz}$, $C_L = 10\text{ }\mu\text{F}$, $C_N = 0.1\text{ }\mu\text{F}$, $V_{IN} = V_{OUT} + 1.5\text{ V}$, $I_{OUT} = 30\text{ mA}$, $V_{RIPPLE} = 100\text{ mVrms}$, (Note 3)		60		dB
V_{NO}	Output Noise Voltage	$10\text{ Hz} \leq f \leq 80\text{ kHz}$, $C_L = 10\text{ }\mu\text{F}$, $C_N = 0.1\text{ }\mu\text{F}$, $V_{CN} = V_{OUT} + 1.5\text{ V}$, $I_{OUT} = 60\text{ mA}$, (Notes 3,4)		30		μVrms
V_{ref}	Noise Bypass Terminal Voltage			1.25		V
$\Delta V_{OUT} / \Delta T$	Temperature Coefficient	$I_{OUT} = 10\text{ mA}$		40		ppm/°C
CONTROL TERMINAL SPECIFICATIONS						
I_{CONT}	Control Current	$V_{CONT} = 1.8\text{ V}$, Output ON		12	35	μA
$V_{CONT(ON)}$	Control Voltage ON	Output ON	1.8			V
$V_{CONT(OFF)}$	Control Voltage OFF	Output OFF			0.6	V

Note 1: When mounted as recommended. Derate at 4.8 mW/°C for SOT-23L and 6.4 mW/°C for SOT-89 packages for operation above 25°C.

Note 2: Refer to "Definition of Terms."

Note 3: Ripple rejection and noise voltage are affected by the value and characteristics of the capacitor used.

Note 4: Output noise voltage can be reduced by connecting a capacitor to a noise pass terminal.

Gen. Note: Parameters with min. or max. values are 100% tested at $T_A = 25\text{ °C}$.

ABSOLUTE MAXIMUM RATINGS TK1121xBC ($V_{OUT} \leq 1.9$ V)

Supply Voltage	16 V	Storage Temperature Range	-55 to +150 °C
Power Dissipation SOT-23L (Note1)	600 mW	Operating Temperature Range	-30 to +80 °C
Power Dissipation SOT-89 (Note1)	900 mW	Operating Voltage Range	1.8 to 14.5 V
Reverse Bias	7 V	Junction Temperature	150 °C

TK1121xBC ELECTRICAL CHARACTERISTICS ($V_{OUT} \leq 1.9$ V)

Test conditions: $T_A = 25$ °C, unless otherwise specified.

SYMBOL	PARAMETER	TEST CONDITIONS	MIN	TYP	MAX	UNITS
I_Q	Quiescent Current	$I_{OUT} = 0$ mA, Excluding I_{CONT}		170	250	μ A
I_{STBY}	Standby Current	$V_{IN} = 8$ V, Output OFF			0.1	μ A
V_{OUT}	Output Voltage	$I_{OUT} = 30$ mA	See Table 2			V
Line Reg	Line Regulation	(Note 2)		3.0	20	mV
Load Reg	Load Regulation	$I_{OUT} = 1$ to 60 mA, (Note 2)		6	30	mV
		$I_{OUT} = 1$ to 100 mA, (Note 2)		18	60	mV
I_{OUT}	Continuous Output Current	2.4 V $\leq V_{IN} \leq 2.6$ V, (Note 2)			130	mA
		$V_{IN} \geq 2.6$ V, (Note 2)			150	mA
$I_{OUT(PULSE)}$	Pulse Output Current	5 ms pulse, $V_{IN} \geq 2.6$ V, 12.5 % duty cycle			180	mA
RR	Ripple Rejection	$f = 400$ Hz, $C_L = 10$ μ F, $C_N = 0.1$ μ F, $V_{IN} = V_{OUT} + 1.5$ V, $I_{OUT} = 30$ mA, $V_{RIPPLE} = 100$ mVrms, (Note 3)		55		dB
V_{NO}	Output Noise Voltage	10 Hz $\leq f \leq 80$ kHz, $C_L = 10$ μ F, $C_N = 0.1$ μ F, $V_{CN} = V_{OUT} + 1.5$ V, $I_{OUT} = 60$ mA, (Notes 3,4)		30		μ Vrms
V_{ref}	Noise Bypass Terminal Voltage			1.25		V
$\Delta V_{OUT} / \Delta T$	Temperature Coefficient	$I_{OUT} = 10$ mA		40		ppm/° C

CONTROL TERMINAL SPECIFICATIONS

I_{CONT}	Control Current	$V_{CONT} = 1.8$ V, Output ON		12	35	μ A
$V_{CONT(ON)}$	Control Voltage ON	Output ON	1.8			V
$V_{CONT(OFF)}$	Control Voltage OFF	Output OFF			0.6	V

Note 1: When mounted as recommended. Derate at 4.8 mW/°C for SOT-23L and 6.4 mW/°C for SOT-89 packages for operation above 25 °C.

Note 2: Refer to "Definition of Terms."

Note 3: Ripple rejection and noise voltage are affected by the value and characteristics of the capacitor used.

Note 4: Output noise voltage can be reduced by connecting a capacitor to a noise pass terminal.

Gen Note: Parameters with min. or max. values are 100% tested at $T_A = 25$ °C.

TK112xxB

ABSOLUTE MAXIMUM RATINGS TK112xxBI ($V_{OUT} \geq 2.5 V$)

Supply Voltage	16 V	Storage Temperature Range	-55 to +150 °C
Power Dissipation SOT-23L (Note1)	600 mW	Operating Temperature Range	-40 to +85 °C
Power Dissipation SOT-89 (Note1)	900 mW	Operating Voltage Range	1.8 to 14.5 V
Reverse Bias	10 V	Junction Temperature	150 °C

TK112xxBI ELECTRICAL CHARACTERISTICS ($V_{OUT} \geq 2.5 V$)

Test conditions: $T_A = -40$ to 85 °C, unless otherwise specified.

SYMBOL	PARAMETER	TEST CONDITIONS	MIN	TYP	MAX	UNITS
I_Q	Quiescent Current	$I_{OUT} = 0$ mA, Excluding I_{CONT}		170	300	μA
I_{STBY}	Standby Current	$V_{IN} = 8$ V, Output OFF			0.2	μA
V_{OUT}	Output Voltage	$I_{OUT} = 30$ mA	See Table 3			V
Line Reg	Line Regulation	$V_{OUT} \leq 5.5$ V, (Note 2)		3.0	25	mV
		$V_{OUT} = 5.6$ V, (Note 2)		15	40	mV
Load Reg	Load Regulation	$I_{OUT} = 1$ to 60 mA, (Note 2)		6	40	mV
		$I_{OUT} = 1$ to 100 mA, (Note 2)		18	80	mV
		$I_{OUT} = 1$ to 150 mA, (Note 2)		23	110	mV
V_{DROP}	Dropout Voltage	$I_{OUT} = 60$ mA, (Note 2)		0.12	0.23	V
		$I_{OUT} = 150$ mA, (Note 2)		0.26	0.40	V
I_{OUT}	Continuous Output Current	(Note 2)			150	mA
$I_{OUT(PULSE)}$	Pulse Output Current	5 ms pulse, 12.5 % duty cycle			180	mA
RR	Ripple Rejection	$f = 400$ Hz, $C_L = 10$ μF , $C_N = 0.1$ μF , $V_{IN} = V_{OUT} + 1.5$ V, $I_{OUT} = 30$ mA, $V_{RIPPLE} = 100$ mVrms, (Note 3)		60		dB
V_{NO}	Output Noise Voltage	10 Hz $\leq f \leq 80$ kHz, $C_L = 10$ μF , $C_N = 0.1$ μF , $V_{CN} = V_{OUT} + 1.5$ V, $I_{OUT} = 60$ mA, (Notes 3,4)		30		$\mu Vrms$
V_{ref}	Noise Bypass Terminal Voltage			1.25		V
$\Delta V_{OUT} / \Delta T$	Temperature Coefficient	$I_{OUT} = 10$ mA		40		ppm/° C

CONTROL TERMINAL SPECIFICATIONS

I_{CONT}	Control Current	$V_{CONT} = 1.8$ V, Output ON		12	40	μA
$V_{CONT(ON)}$	Control Voltage ON	Output ON	2.0			V
$V_{CONT(OFF)}$	Control Voltage OFF	Output OFF			0.5	V

Note 1: When mounted as recommended. Derate at 4.8 mW/°C for SOT-23L and 6.4 mW/°C for SOT-89 packages for operation above 25 °C.

Note 2: Refer to "Definition of Terms."

Note 3: Ripple rejection and noise voltage are affected by the value and characteristics of the capacitor used.

Note 4: Output noise voltage can be reduced by connecting a capacitor to a noise pass terminal.

Gen Note: Parameters with min. or max. values are 100% tested at $T_A = 25$ °C.

Gen Note: For Line Regulation, typ. and max. is changed to $V_{OUT} > 5.6$ V.

TK112xxBMC ELECTRICAL CHARACTERISTICS TABLE 1Test conditions: $T_A = 25\text{ }^\circ\text{C}$, $I_{OUT} = 30\text{ mA}$, unless otherwise specified.

Output Voltage	Voltage Code	$V_{OUT(MIN)}$	$V_{OUT(MAX)}$	Test Voltage
1.3 V	13	1.240 V	1.36 V	2.4 V
1.4 V	14	1.340 V	1.46 V	2.4 V
1.5 V	15	1.440 V	1.560 V	2.4 V
1.6 V	16	1.540 V	1.660 V	2.4 V
1.7 V	17	1.640 V	1.760 V	2.4 V
1.8 V	18	1.740 V	1.860 V	2.4 V
1.9 V	19	1.804 V	1.960 V	2.4 V

TK112xxBC ELECTRICAL CHARACTERISTICS TABLE 2Test conditions: $T_A = 25\text{ }^\circ\text{C}$, $I_{OUT} = 30\text{ mA}$, unless otherwise specified.

Output Voltage	Voltage Code	$V_{OUT(MIN)}$	$V_{OUT(MAX)}$	Test Voltage	Output Voltage	Voltage Code	$V_{OUT(MIN)}$	$V_{OUT(MAX)}$	Test Voltage
2.0 V	20	1.940 V	2.060 V	3.0 V	3.7 V	37	3.630 V	3.770 V	4.7 V
2.1 V	21	2.040 V	2.160 V	3.1 V	3.8 V	38	3.725 V	3.875 V	4.8 V
2.2 V	22	2.140 V	2.260 V	3.2 V	3.9 V	39	3.825 V	3.975 V	4.9 V
2.3 V	23	2.240 V	2.360 V	3.3 V	4.0 V	40	3.920 V	4.080 V	5.0 V
2.4 V	24	2.340 V	2.460 V	3.4 V	4.1 V	41	4.020 V	4.180 V	5.1 V
2.5 V	25	2.440 V	2.560 V	3.5 V	4.2 V	42	4.120 V	4.280 V	5.2 V
2.6 V	26	2.540 V	2.660 V	3.6 V	4.3 V	43	4.215 V	4.385 V	5.3 V
2.7 V	27	2.640 V	2.760 V	3.7 V	4.4 V	44	4.315 V	4.485 V	5.4 V
2.8 V	28	2.740 V	2.860 V	3.8 V	4.5 V	45	4.410 V	4.590 V	5.5 V
2.9 V	29	2.840 V	2.960 V	3.9 V	4.6 V	46	4.510 V	4.690 V	5.6 V
3.0 V	30	2.940 V	3.060 V	4.0 V	4.7 V	47	4.605 V	4.795 V	5.7 V
3.1 V	31	3.040 V	3.160 V	4.1 V	4.8 V	48	4.705 V	4.895 V	5.8 V
3.2 V	32	3.140 V	3.260 V	4.2 V	4.9 V	49	4.800 V	5.000 V	5.9 V
3.3 V	33	3.240 V	3.360 V	4.3 V	5.0 V	50	4.900 V	5.100 V	6.0 V
3.4 V	34	3.335 V	3.465 V	4.4 V	5.5 V	55	5.390 V	5.610 V	6.5 V
3.5 V	35	3.435 V	3.565 V	4.5 V	8.0 V	80	7.840 V	8.160 V	9.0 V
3.6 V	36	3.535 V	3.665 V	4.6 V					

TK112xxB

TK112xxBI ELECTRICAL CHARACTERISTICS TABLE 3

Test Conditions: $V_{IN} = V_{OUT(TYP)} + 1 \text{ V}$, $I_{OUT} = 30 \text{ mA}$, unless otherwise specified.

Output Voltage	Voltage Code	Room Temp. Range ($T_A = 25 \text{ }^\circ\text{C}$)		Full Temp. Range ($T_A = -40 \text{ to } +85 \text{ }^\circ\text{C}$)	
		$V_{OUT(MIN)}$	$V_{OUT(MAX)}$	$V_{OUT(MIN)}$	$V_{OUT(MAX)}$
2.5 V	25	2.440 V	2.560 V	2.400 V	2.600 V
2.6 V	26	2.540 V	2.660 V	2.500 V	2.700 V
2.7 V	27	2.640 V	2.760 V	2.600 V	2.800 V
2.8 V	28	2.750 V	2.860 V	2.700 V	2.900 V
2.9 V	29	2.840 V	2.960 V	2.800 V	3.000 V
3.0 V	30	2.940 V	3.060 V	2.900 V	3.100 V
3.1 V	31	3.040 V	3.160 V	3.000 V	3.200 V
3.2 V	32	3.140 V	3.260 V	3.095 V	3.305 V
3.3 V	33	3.240 V	3.360 V	3.190 V	3.410 V
3.4 V	34	3.335 V	3.465 V	3.290 V	3.510 V
3.5 V	35	3.435 V	3.565 V	3.385 V	3.615 V
3.6 V	36	3.535 V	3.665 V	3.485 V	3.720 V
3.7 V	37	3.630 V	3.770 V	3.580 V	3.820 V
3.8 V	38	3.725 V	3.875 V	3.675 V	3.925 V
3.9 V	39	3.825 V	3.975 V	3.770 V	4.030 V
4.0 V	40	3.920 V	4.080 V	3.870 V	4.130 V
4.1 V	41	4.020 V	4.180 V	3.965 V	4.235 V
4.2 V	42	4.120 V	4.280 V	4.060 V	4.335 V
4.3 V	43	4.215 V	4.385 V	4.160 V	4.440 V
4.4 V	44	4.315 V	4.485 V	4.255 V	4.545 V
4.5 V	45	4.410 V	4.590 V	4.350 V	4.645 V
4.6 V	46	4.510 V	4.690 V	4.450 V	4.750 V
4.7 V	47	4.605 V	4.795 V	4.545 V	4.850 V
4.8 V	48	4.705 V	4.895 V	4.640 V	4.955 V
4.9 V	49	4.800 V	5.000 V	4.740 V	5.060 V
5.0 V	50	4.900 V	5.100 V	4.835 V	5.165 V
5.5 V	55	5.390 V	5.610 V	5.320 V	5.680 V
8.0 V	80	7.840 V	8.160 V	7.745 V	8.265 V

TEST CIRCUITS

SOT-23L

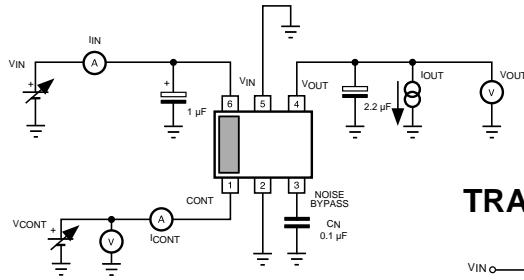

SOT-89

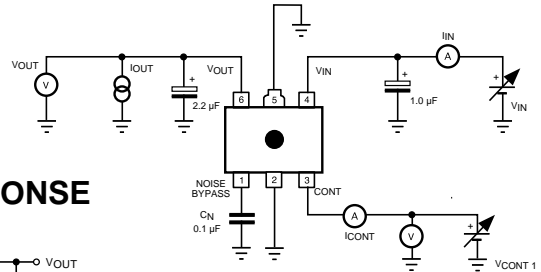

TRANSIENT RESPONSE

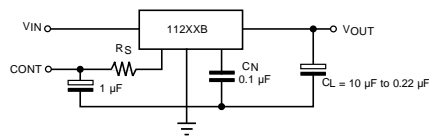

Note: Connect pin 5 to ground for heat sink

TYPICAL PERFORMANCE CHARACTERISTICS

$T_A = 25\text{ }^\circ\text{C}$, unless otherwise specified.

OUTPUT VOLTAGE RESPONSE (OFF→ON)

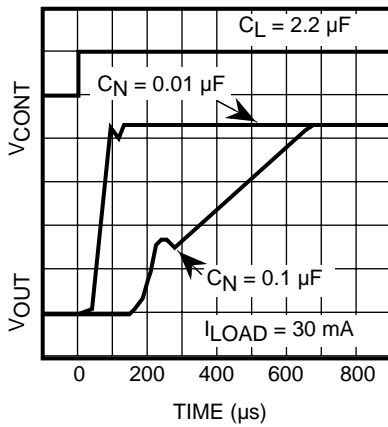

LOAD REGULATION

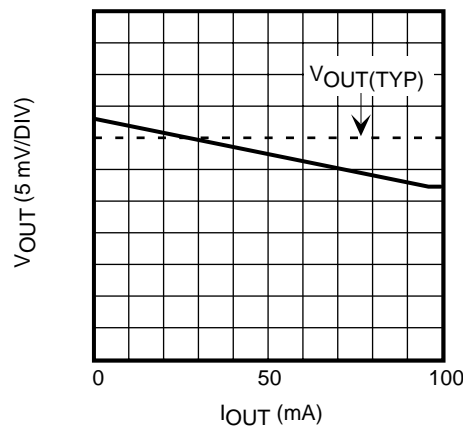

SHORT CIRCUIT CURRENT

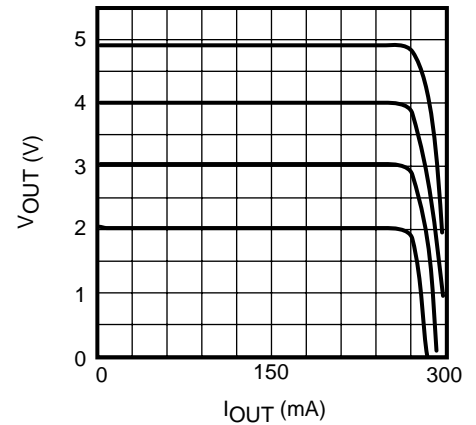

OUTPUT VOLTAGE vs. INPUT VOLTAGE

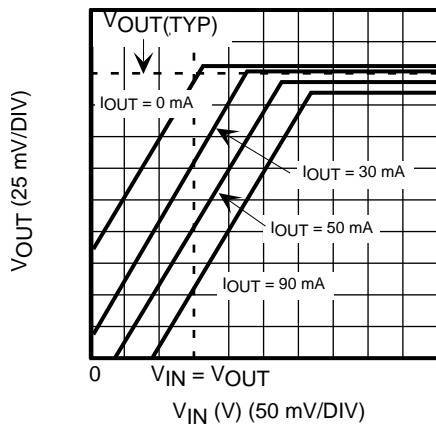

LINE REGULATION

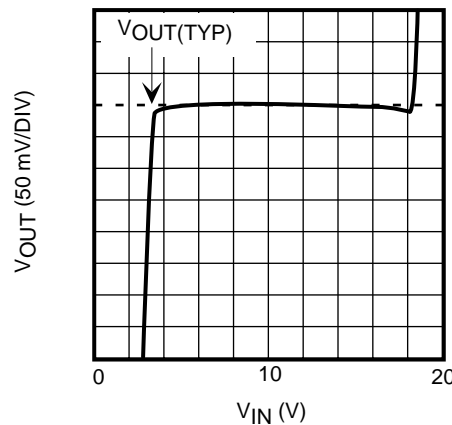

DROPOUT VOLTAGE vs. OUTPUT CURRENT

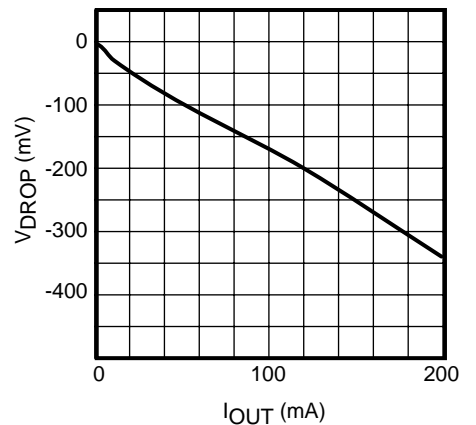

TYPICAL PERFORMANCE CHARACTERISTICS (CONT.)

$T_A = 25\text{ }^\circ\text{C}$, unless otherwise specified.

GROUND CURRENT vs. OUTPUT CURRENT

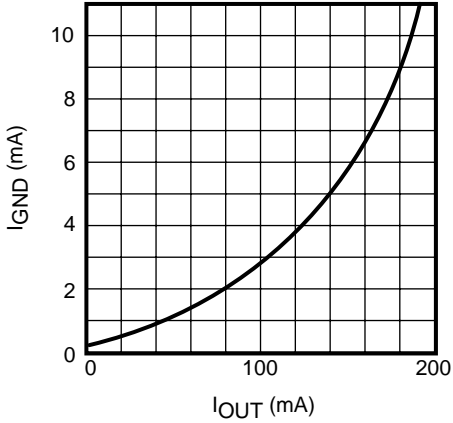

REVERSE BIAS CURRENT ($V_{IN} = 0\text{ V}$)

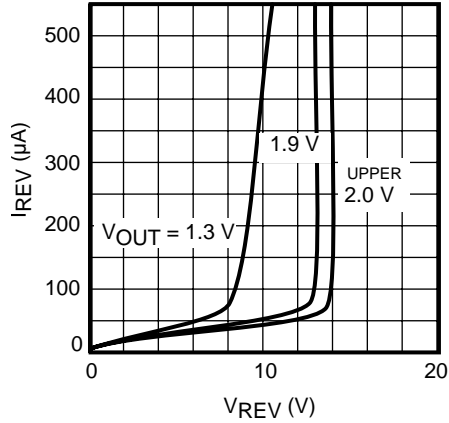

QUIESCENT CURRENT (OFF MODE) vs. INPUT VOLTAGE

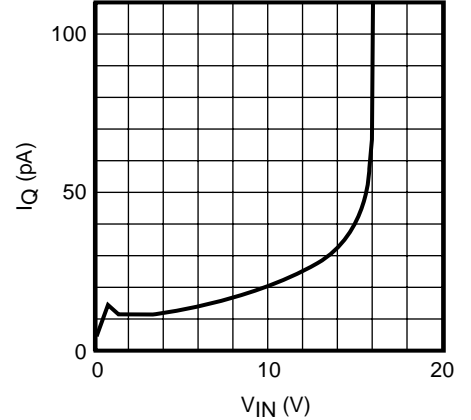

QUIESCENT CURRENT (ON MODE) vs. INPUT VOLTAGE

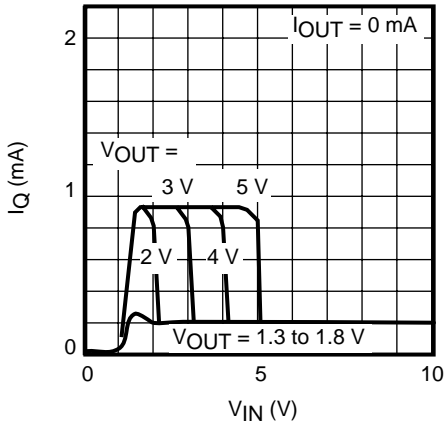

QUIESCENT CURRENT (ON MODE) vs. INPUT VOLTAGE

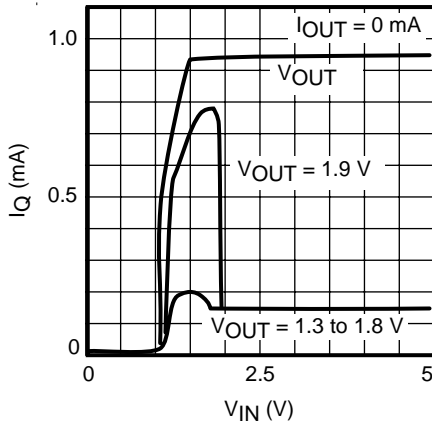

GROUND CURRENT

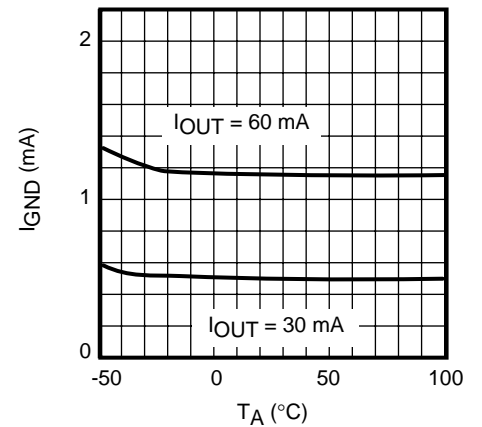

DROPOUT VOLTAGE

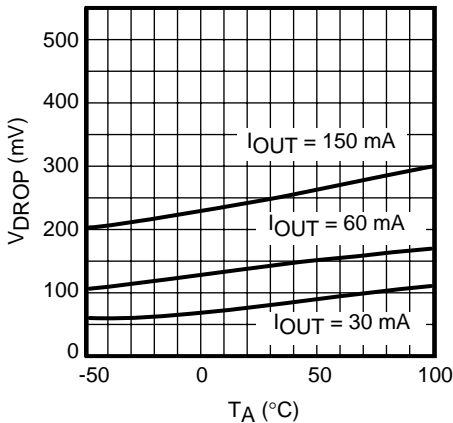

CONTROL CURRENT

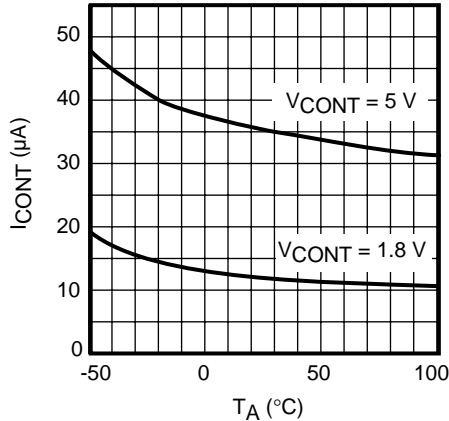

V_{CONT} (V_{OUT} , ON POINT)

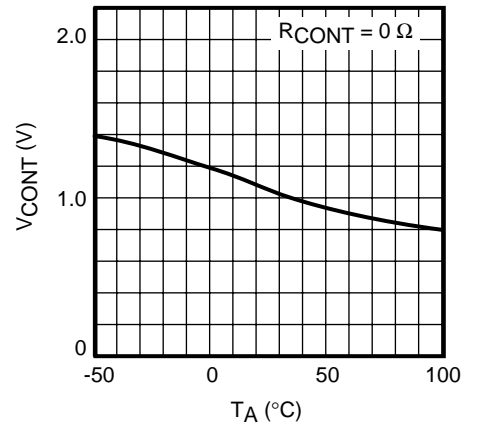

TYPICAL PERFORMANCE CHARACTERISTICS (CONT.)

$T_A = 25\text{ }^\circ\text{C}$, unless otherwise specified.

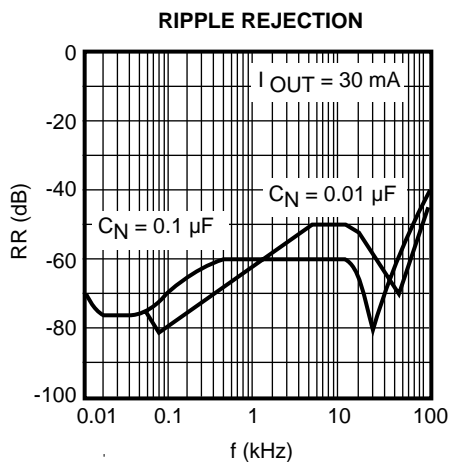
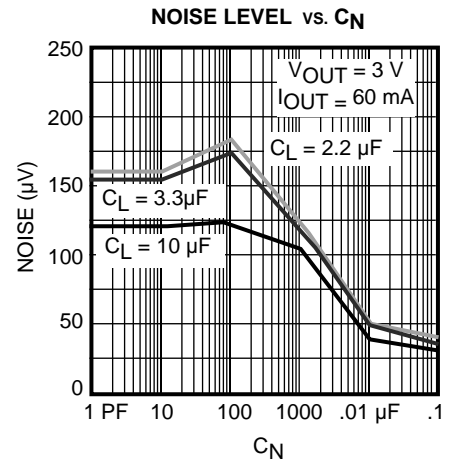
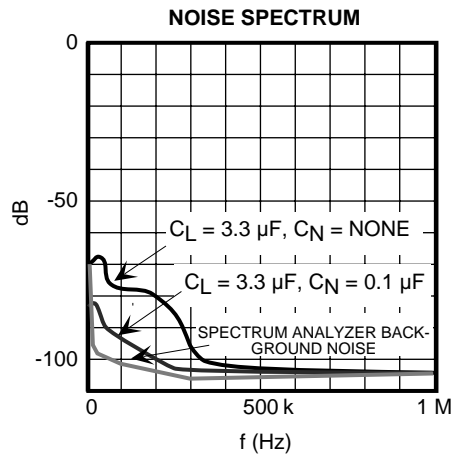
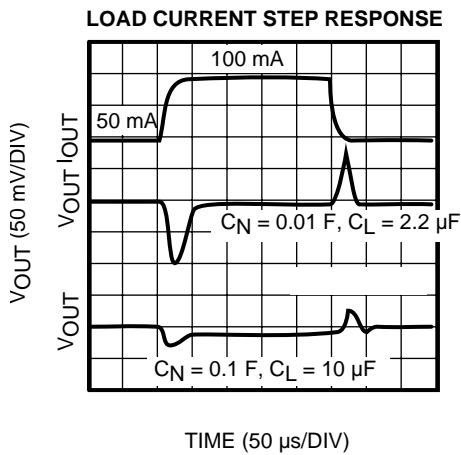
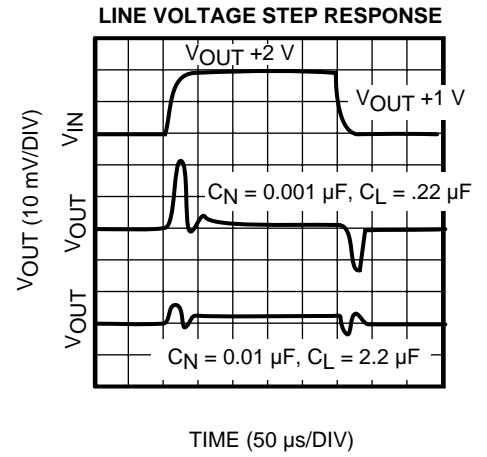
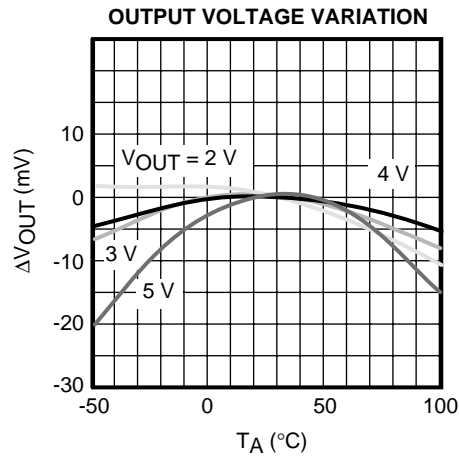
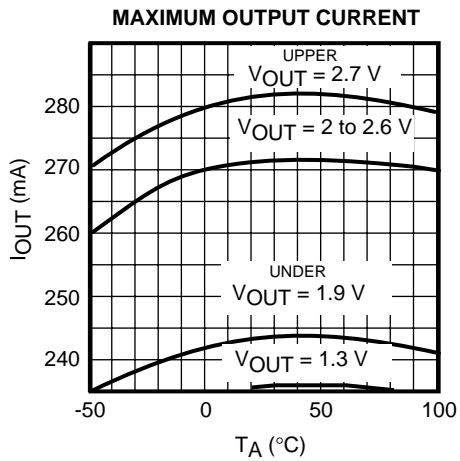

TK112xxB

TYPICAL PERFORMANCE CHARACTERISTICS (CONT.)

$T_A = 25\text{ }^\circ\text{C}$, unless otherwise specified.

TK11213B

OUTPUT VOLTAGE vs. INPUT VOLTAGE

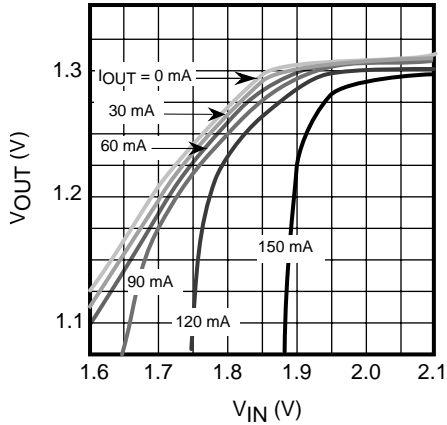

OUTPUT VOLTAGE vs. OUTPUT CURRENT

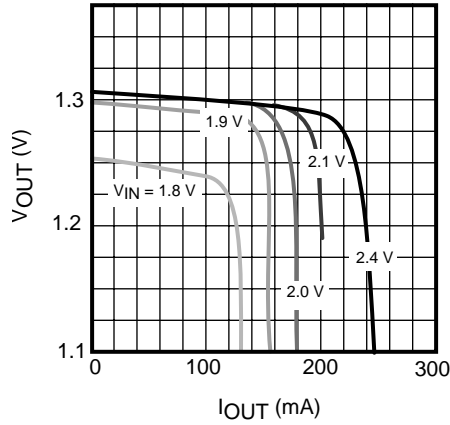

TK11214B

OUTPUT VOLTAGE vs. INPUT VOLTAGE

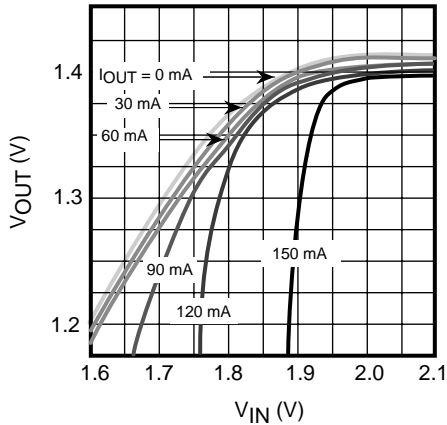

OUTPUT VOLTAGE vs. OUTPUT CURRENT

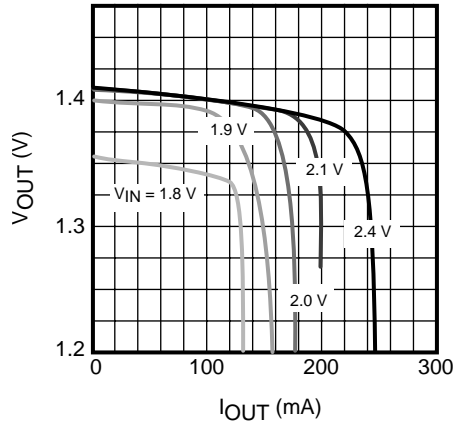

TK11215B

OUTPUT VOLTAGE vs. INPUT VOLTAGE

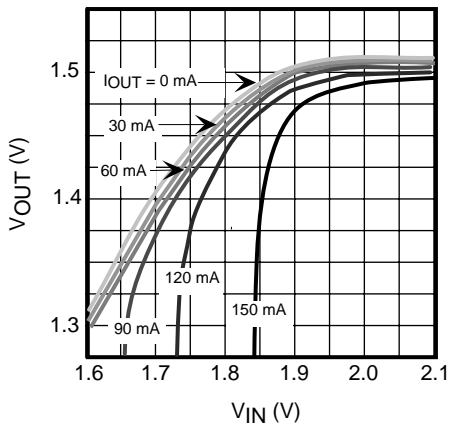

OUTPUT VOLTAGE vs. OUTPUT CURRENT

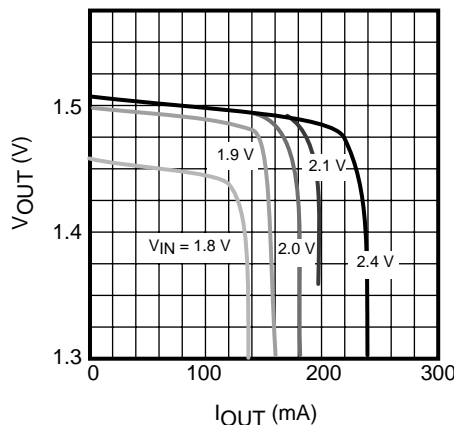

TYPICAL PERFORMANCE CHARACTERISTICS (CONT.)

$T_A = 25\text{ }^\circ\text{C}$, unless otherwise specified.

TK11216B

OUTPUT VOLTAGE vs. INPUT VOLTAGE

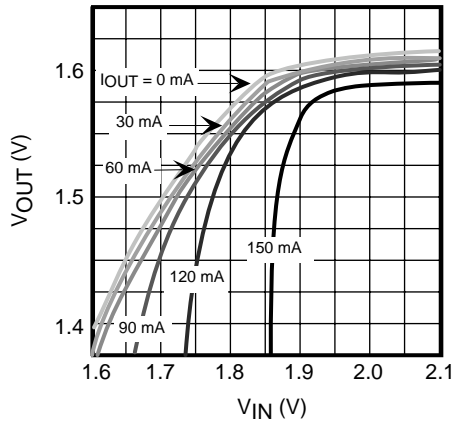

OUTPUT VOLTAGE vs. OUTPUT CURRENT

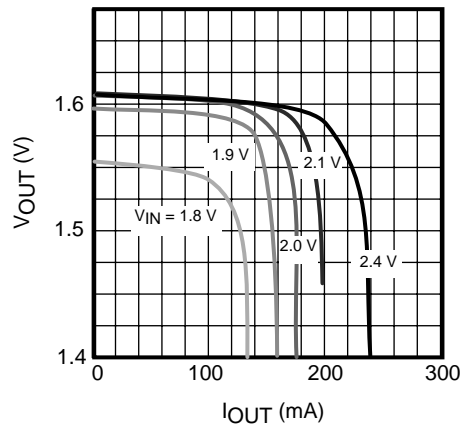

TK11217B

OUTPUT VOLTAGE vs. INPUT VOLTAGE

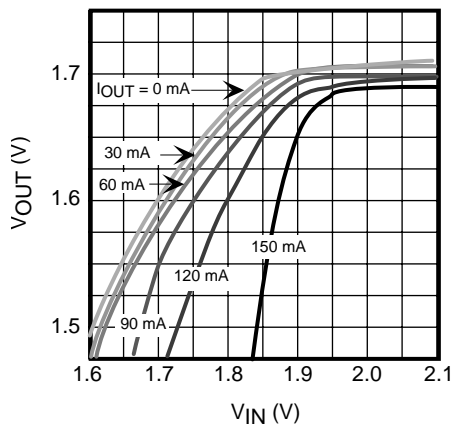

OUTPUT VOLTAGE vs. OUTPUT CURRENT

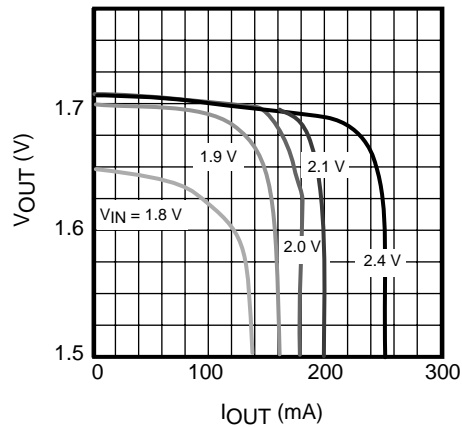

TK11218B

OUTPUT VOLTAGE vs. INPUT VOLTAGE

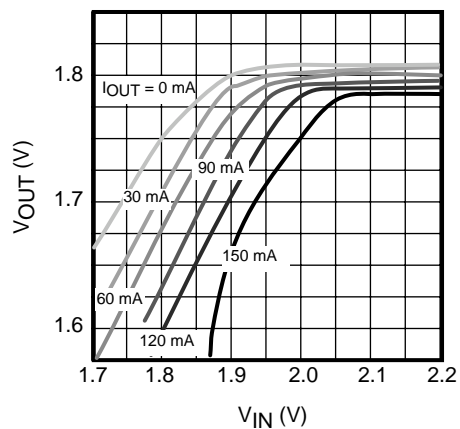

OUTPUT VOLTAGE vs. OUTPUT CURRENT

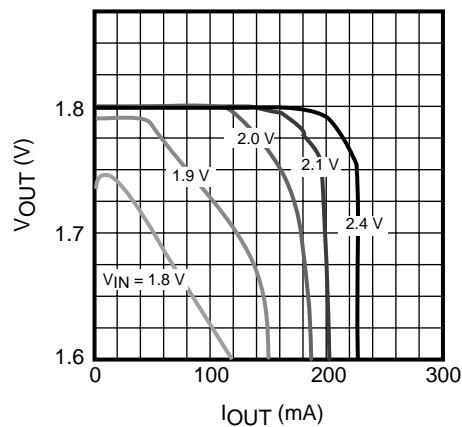

TK112xxB

TYPICAL PERFORMANCE CHARACTERISTICS (CONT.)

$T_A = 25\text{ }^\circ\text{C}$, unless otherwise specified.

TK11219B

OUTPUT VOLTAGE vs. INPUT VOLTAGE

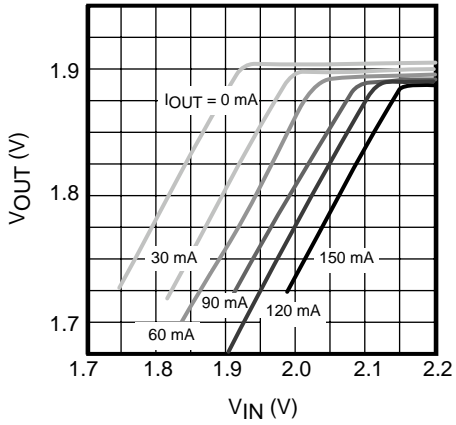

OUTPUT VOLTAGE vs. OUTPUT CURRENT

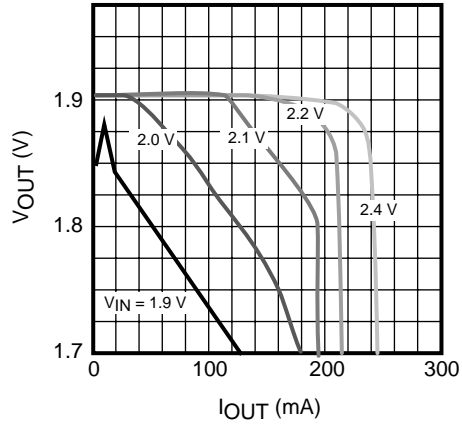

DEFINITION AND EXPLANATION OF TECHNICAL TERMS

OUTPUT VOLTAGE (V_{OUT})

The output voltage is specified with $V_{IN} = (V_{OUT(TYP)} + 1 \text{ V})$ and $I_{OUT} = 30 \text{ mA}$.

DROPOUT VOLTAGE (V_{DROP})

The dropout voltage is the difference between the input voltage and the output voltage at which point the regulator starts to fall out of regulation. Below this value, the output voltage will fall as the input voltage is reduced. It is dependent upon the load current and the junction temperature.

OUTPUT CURRENT ($I_{OUT(MAX)}$)

This is the maximum continuous output current specified under the condition where the output voltage drops 0.3 V below the value specified with $I_{OUT} = 30 \text{ mA}$. The input voltage is set to $V_{OUT} + 1 \text{ V}$, and the current is pulsed to minimize temperature effect.

CONTINUOUS OUTPUT CURRENT (I_{OUT})

Normal operating output current. This is limited by package power dissipation.

PULSE OUTPUT CURRENT ($I_{OUT(PULSE)}$)

Maximum pulse width 5 ms at V_{OUT} upper 2.0 V; 7 ms. at V_{OUT} under 1.9 V; duty cycle 12.5%: pulse load only.

LINE REGULATION (Line Reg)

Line regulation is the ability of the regulator to maintain a constant output voltage as the input voltage changes. The line regulation is specified as the input voltage is changed from $V_{IN} = V_{OUT(TYP)} + 1 \text{ V}$ to $V_{IN} = V_{OUT(TYP)} + 6 \text{ V}$.

LOAD REGULATION (Load Reg)

Load regulation is the ability of the regulator to maintain a constant output voltage as the load current changes. It is a pulsed measurement to minimize temperature effects with the input voltage set to $V_{IN} = V_{OUT} + 1 \text{ V}$. The load regulation is specified under two output current step conditions of 1 mA to 60 mA and 1 mA to 100 mA.

QUIESCENT CURRENT (I_Q)

The quiescent current is the current which flows through the ground terminal under no load conditions ($I_{OUT} = 0 \text{ mA}$).

GROUND CURRENT (I_{GND})

Ground current is the current which flows through the ground pin(s). It is defined as $I_{IN} - I_{OUT}$, excluding I_{CONT} .

RIPPLE REJECTION RATIO (RR)

Ripple rejection is the ability of the regulator to attenuate the ripple content of the input voltage at the output. It is specified with 100 mVrms, 400 Hz superimposed on the input voltage, where $V_{IN} = V_{OUT} + 1.5 \text{ V}$. The output decoupling capacitor is set to 10 μF , the noise bypass capacitor is set to 0.1 μF , and the load current is set to 30 mA. Ripple rejection is the ratio of the ripple content of the output vs. the input and is expressed in dB.

STANDBY CURRENT (I_{STBY})

Standby current is the current which flows into the regulator when the output is turned off by the control function ($V_{CONT} = 0 \text{ V}$). It is measured with $V_{IN} = 8 \text{ V}$ (9 V for the 8 V output device).

SENSOR CIRCUITS

Overcurrent Sensor

The overcurrent sensor protects the device in the event that the output is shorted to ground.

Thermal Sensor

The thermal sensor protects the device in the event that the junction temperature exceeds the safe value ($T_J = 150 \text{ }^\circ\text{C}$). This temperature rise can be caused by external heat, excessive power dissipation caused by large input to output voltage drops, or excessive output current. The regulator will shut off when the temperature exceeds the safe value. As the junction temperatures decrease, the regulator will begin to operate again. Under sustained fault conditions, the regulator output will oscillate as the device turns off then resets. Damage may occur to the device under extreme fault conditions.

DEFINITION AND EXPLANATION OF TECHNICAL TERMS (CONT.)

Reverse Voltage Protection

Reverse voltage protection prevents damage due to the output voltage being higher than the input voltage. This fault condition can occur when the output capacitor remains charged and the input is reduced to zero, or when an external voltage higher than the input voltage is applied to the output side.

If the control function is not used, connect the control terminal to V_{IN} . When the control function is used, the control current can be reduced by inserting a series resistor (R_{CONT}) between the control terminal and V_{IN} . The value of this resistor should be determined from the graph below.

CONTROL FUNCTION

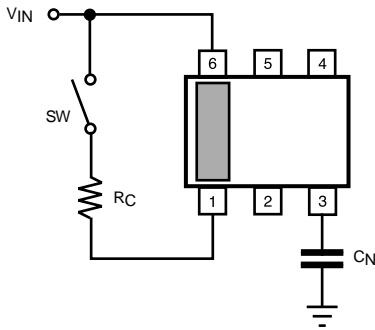

SOT-23L

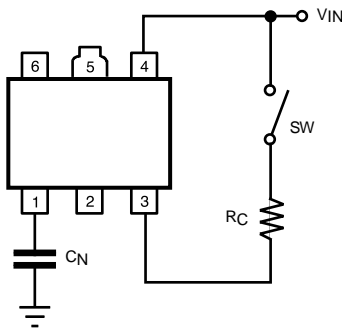

SOT-89

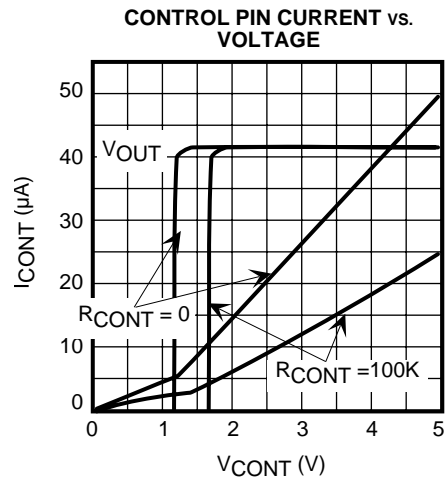

DEFINITION AND EXPLANATION OF TECHNICAL TERMS (CONT.)

ON/OFF RESPONSE WITH CONTROL AND LOAD TRANSIENT RESPONSE

The turn-on time depends upon the value of the output capacitor and the noise bypass capacitor. The turn-on time will increase with the value of either capacitor. The graphs below show the relationship between turn-on time and load capacitance. If the value of these capacitors is reduced, the load and line regulation will suffer and the noise voltage will increase. If the value of these capacitors is increased, the turn-on time will increase.

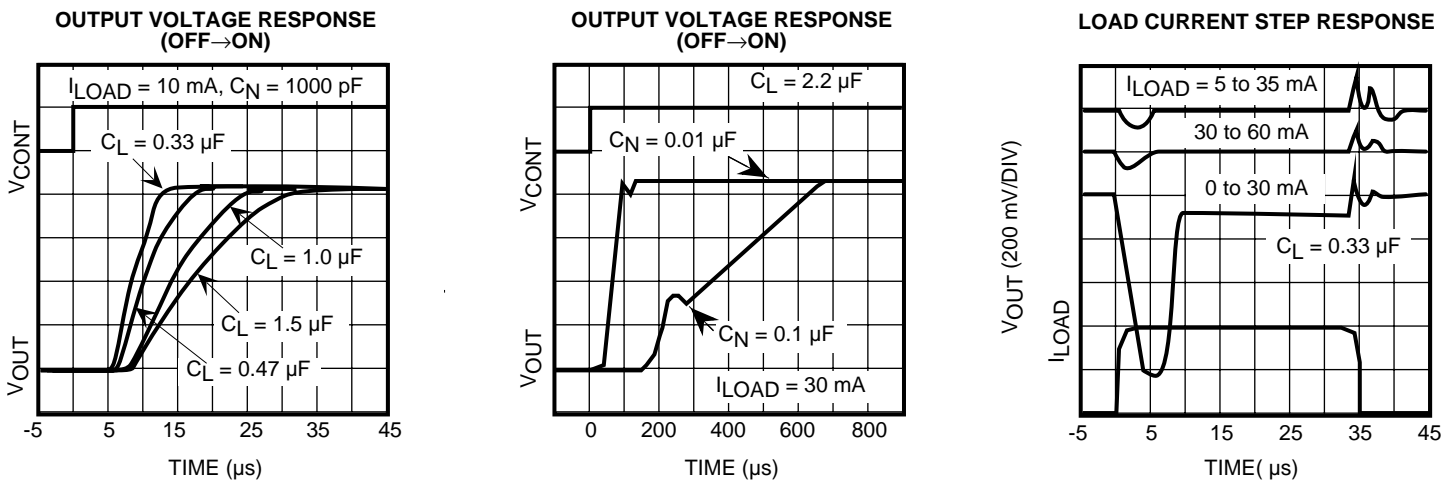

REDUCTION OF OUTPUT NOISE

Although the architecture of the Toko regulators is designed to minimize semiconductor noise, further reduction can be achieved by the selection of external components. The obvious solution is to increase the size of the output capacitor. A more effective solution would be to add a capacitor to the noise bypass terminal. The value of this capacitor should be $0.1 \mu\text{f}$ or higher (higher values provide greater noise reduction). Although stable operation is possible without the noise bypass capacitor, this terminal has a high impedance and care should be taken to avoid a large circuit area on the printed circuit board when the capacitor is not used. Please note that several parameters are affected by the value of the capacitors and bench testing is recommended when deviating from standard values.

DEFINITION AND EXPLANATION OF TECHNICAL TERMS (CONT.)

PACKAGE POWER DISSIPATION (P_D)

This is the power dissipation level at which the thermal sensor is activated. The IC contains an internal thermal sensor which monitors the junction temperature. When the junction temperature exceeds the monitor threshold of 150 °C, the IC is shut down. The junction temperature rises as the difference between the input power ($V_{IN} \times I_{IN}$) and the output power ($V_{OUT} \times I_{OUT}$) increases. The rate of temperature rise is greatly affected by the mounting pad configuration on the PCB, the board material, and the ambient temperature. When the IC mounting has good thermal conductivity, the junction temperature will be low even if the power dissipation is great. When mounted on the recommended mounting pad, the power dissipation of the SOT-23L is increased to 600 mW. For operation at ambient temperatures over 25 °C, the power dissipation of the SOT-23L device should be derated at 4.8 mW/°C. The power dissipation of the SOT-89 package is 900 mW when mounted as recommended. Derate the power dissipation at 7.2 mW/°C for operation above 25 °C. To determine the power dissipation for shutdown when mounted, attach the device on the actual PCB and deliberately increase the output current (or raise the input voltage) until the thermal protection circuit is activated. Calculate the power dissipation of the device by subtracting the output power from the input power. These measurements should allow for the ambient temperature of the PCB. The value obtained from $P_D / (150\text{ °C} - T_A)$ is the derating factor. The PCB mounting pad should provide maximum thermal conductivity in order to maintain low device temperatures. As a general rule, the lower the temperature, the better the reliability of the device. The thermal resistance when mounted is expressed as follows:

$$T_j = \theta_{jA} \times P_D + T_A$$

For Toko ICs, the internal limit for junction temperature is 150 °C. If the ambient temperature (T_A) is 25 °C, then:

$$150\text{ °C} = \theta_{jA} \times P_D + 25\text{ °C}$$

$$\theta_{jA} = 125\text{ °C} / P_D$$

P_D is the value when the thermal sensor is activated. A simple way to determine P_D is to calculate $V_{IN} \times I_{IN}$ when

the output side is shorted. Input current gradually falls as temperature rises. You should use the value when thermal equilibrium is reached.

The range of usable currents can also be found from the graph below.

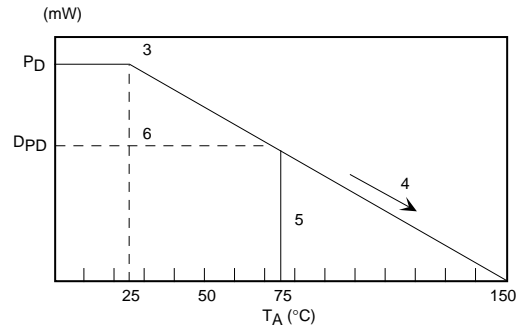

Procedure:

- 1) Find P_D
- 2) P_{D1} is taken to be $P_D \times (-0.8 - 0.9)$
- 3) Plot P_{D1} against 25 °C
- 4) Connect P_{D1} to the point corresponding to the 150 °C with a straight line.
- 5) In design, take a vertical line from the maximum operating temperature (e.g., 75 °C) to the derating curve.
- 6) Read off the value of P_D against the point at which the vertical line intersects the derating curve. This is taken as the maximum power dissipation, D_{PD} .

The maximum operating current is:

$$I_{OUT} = (D_{PD} / (V_{IN(MAX)} - V_{OUT}))$$

DEFINITION AND EXPLANATION OF TECHNICAL TERMS (CONT.)

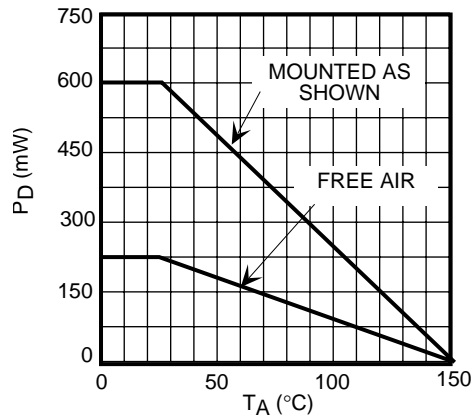

SOT-23L POWER DISSIPATION CURVE

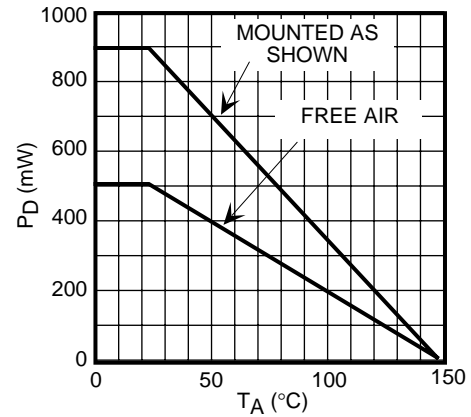

SOT-89 POWER DISSIPATION CURVE

SOT-23L BOARD LAYOUT

SOT-89 BOARD LAYOUT

APPLICATION NOTE

Copper pattern should be as large as possible. Power dissipation is 600 mW for SOT-23L and 900 mW for SOT-89. A low Equivalent Series Resistance (ESR) capacitor is recommended. For low temperature operation, select a capacitor with a low ESR at the lowest operating temperature to prevent oscillation, degradation of ripple rejection and increase in noise. The minimum recommended capacitance is 2.2 μ F.

APPLICATION INFORMATION

INPUT-OUTPUT CAPACITORS

Linear regulators require an output capacitor in order to maintain regulator loop stability. This capacitor should be selected to ensure stable operation over the desired temperature and load range. The graphs below show the effects of capacitance value and ESR on the stable operation area.

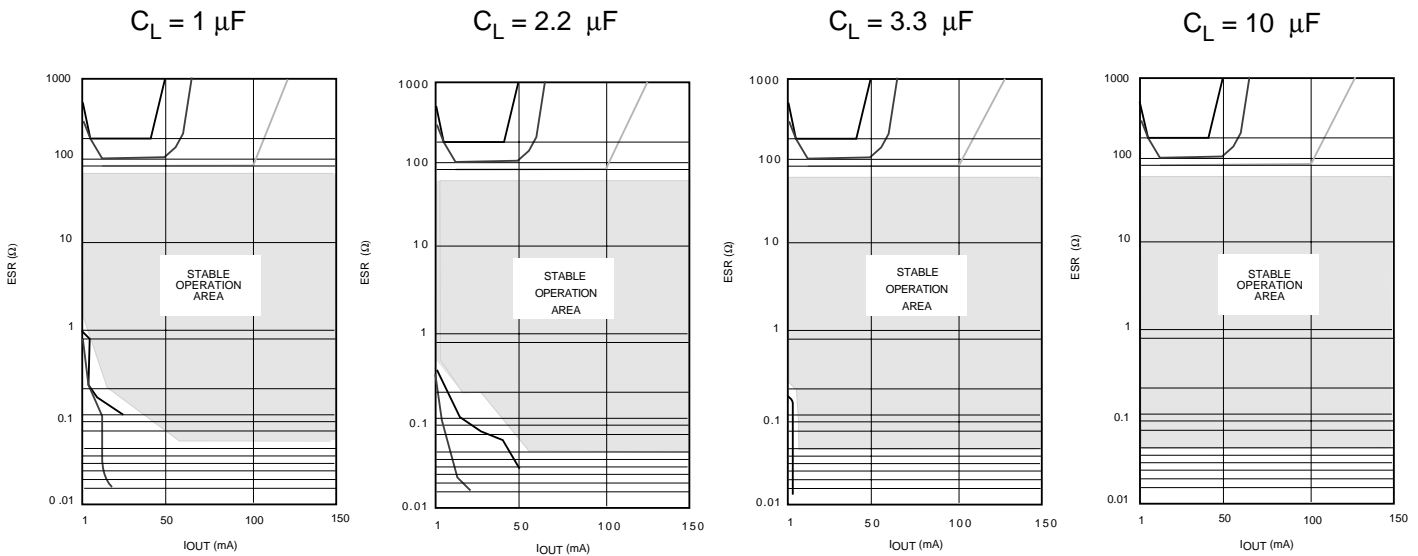
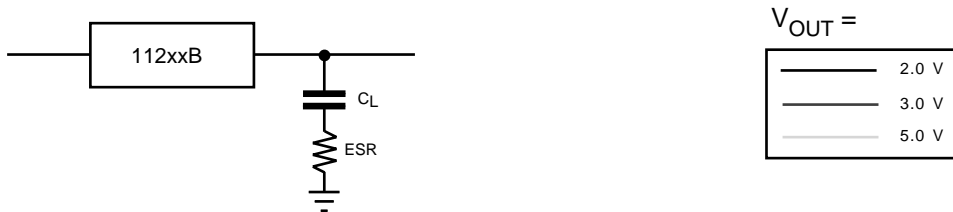

In general, the capacitor should be at least 1 μF (aluminum electrolytic) and be rated for the actual ambient operating temperature range. The table below shows typical characteristics for several types and values of capacitance. Please note that the ESR varies widely depending upon manufacturer, type, size, and material.

ESR / Capacitance	Aluminum Capacitor	Tantalum Capacitor	Ceramic Capacitor
1.0 μF	2.4 Ω	2.3 Ω	0.140 Ω
2.2 μF	2.0 Ω	1.9 Ω	0.059 Ω
3.3 μF	4.6 Ω	1.0 Ω	0.049 Ω
10 μF	1.4 Ω	0.5 Ω	0.025 Ω

Note: ESR is measured at 10 kHz.

COMPARISON BETWEEN TK112xx and TK112xxB

Specification Parameter	TK112xx	TK112xxB
Output voltage tolerance	3.0%	2.0%
Quiescent current	180 μ A	170 μ A
Output current	130 mA	150 mA
Dropout voltage ($I_{OUT} = 50$ mA)	160 mV	110 mV
Ripple rejection at low line regulation point (See Figure below)		Superior
Built-in reverse bias protection	NO	YES
ESD protection		Superior

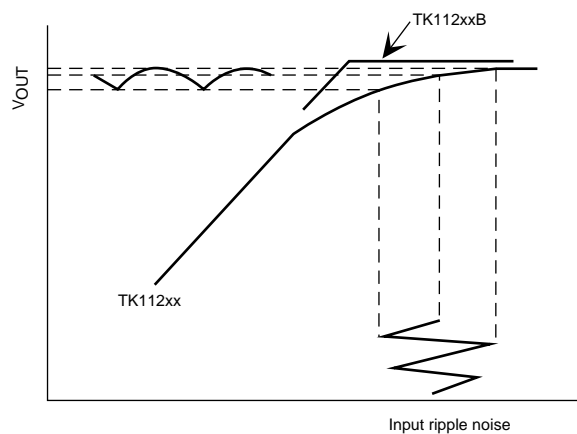

COMPARISON BETWEEN TK112xx and TK112xxB

TK112xx

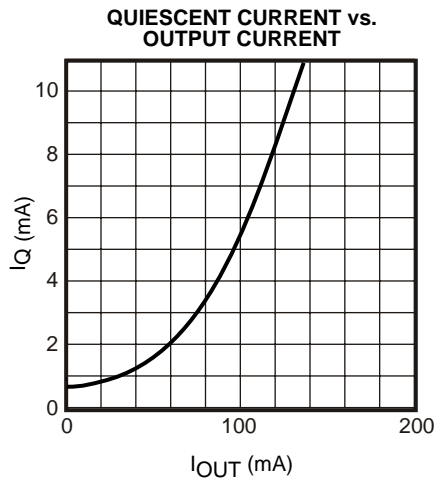

TK112xxB

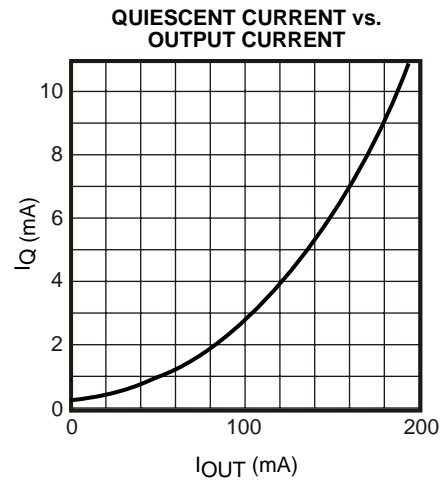

SHORT CIRCUIT CURRENT

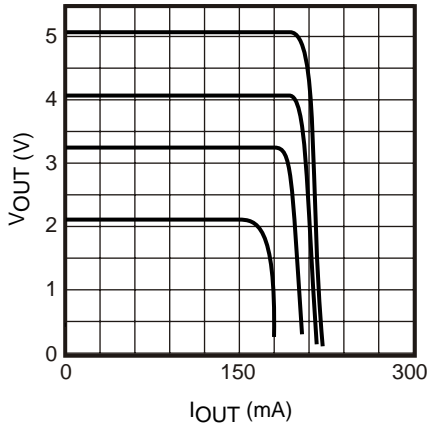

SHORT CIRCUIT CURRENT

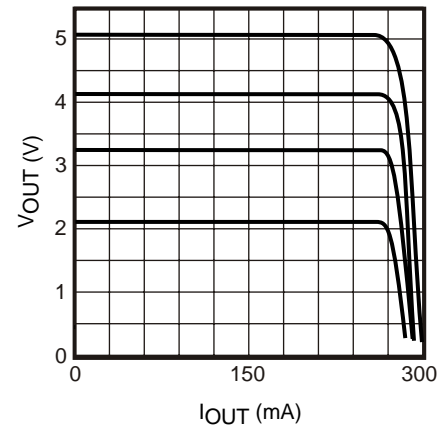

DROPOUT VOLTAGE vs. OUTPUT CURRENT

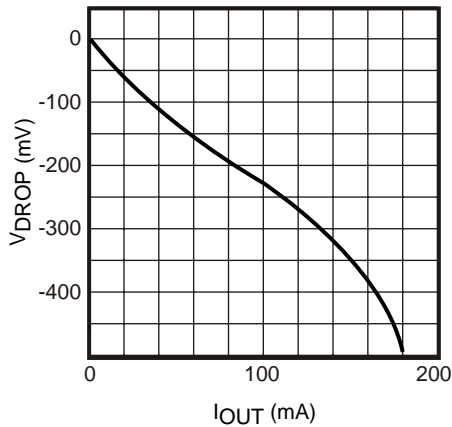

DROPOUT VOLTAGE vs. OUTPUT CURRENT

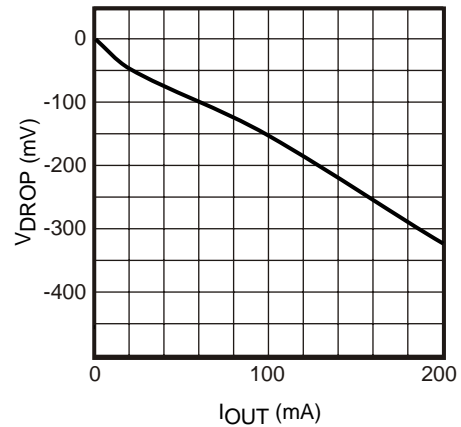

COMPARISON BETWEEN TK112xx and TK112xxB

TK112xx

TK112xxB

OUTPUT VOLTAGE vs. INPUT VOLTAGE

OUTPUT VOLTAGE vs. INPUT VOLTAGE

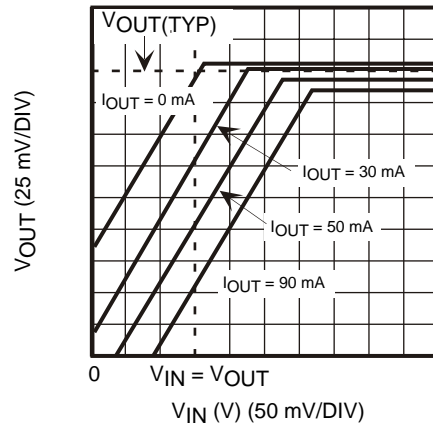
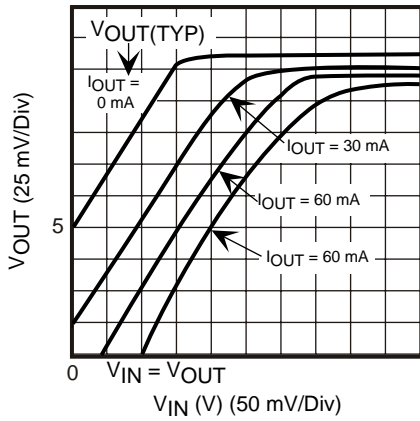

REVERSE BIAS CURRENT

REVERSE BIAS CURRENT

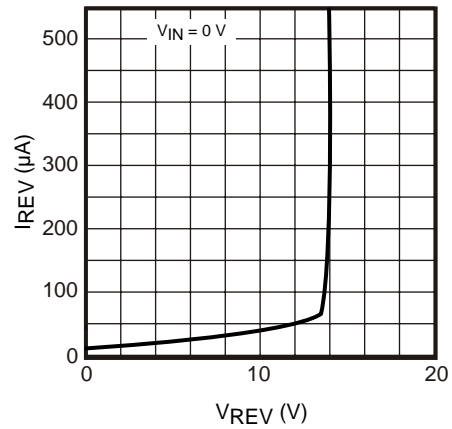
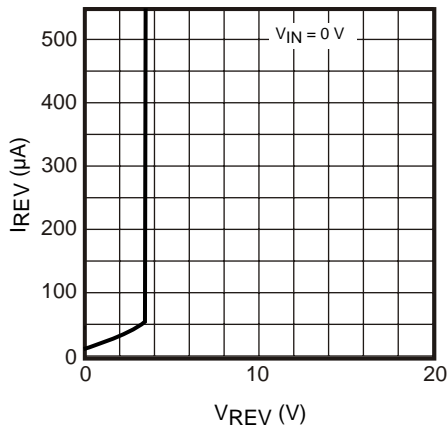

LOAD REGULATION

LOAD REGULATION

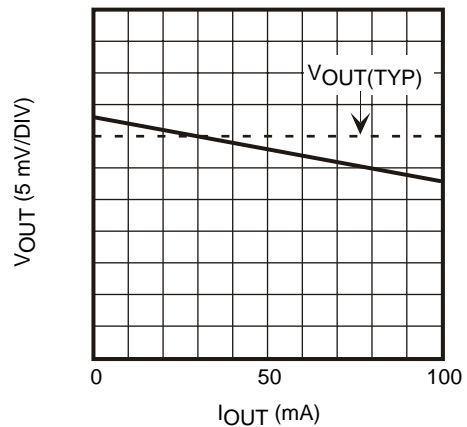
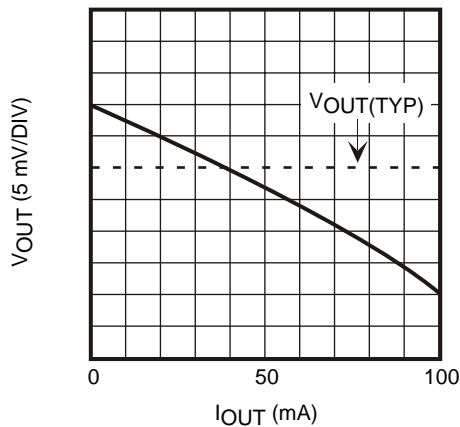

COMPARISON BETWEEN TK112xx and TK112xxB

TK112xx

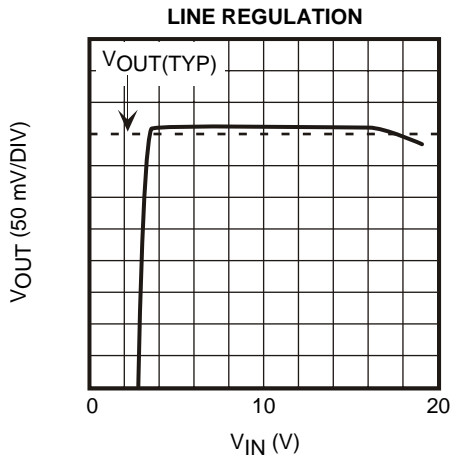

TK112xxB

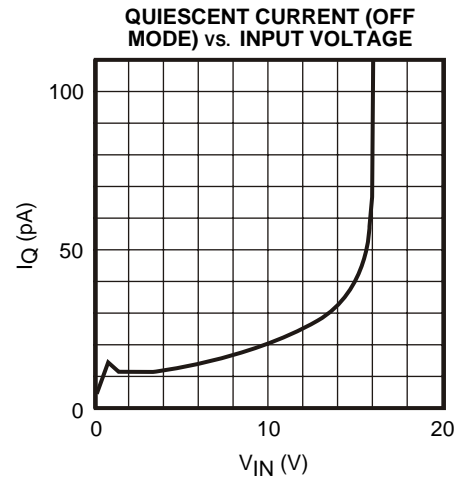
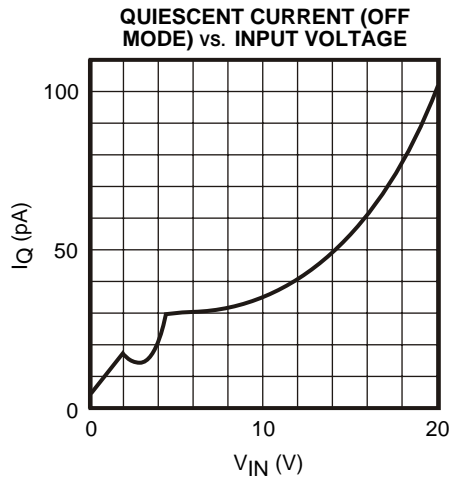
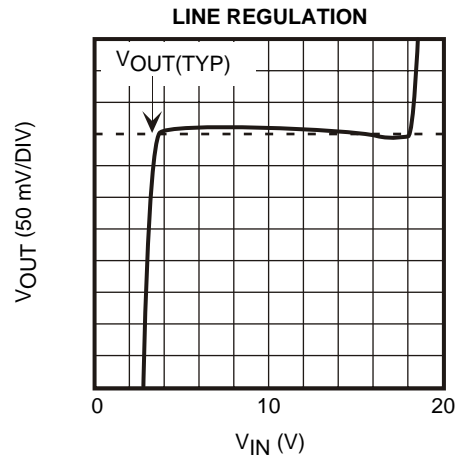

NOTES

PACKAGE OUTLINE

SOT-23L (SOT-23L-6)

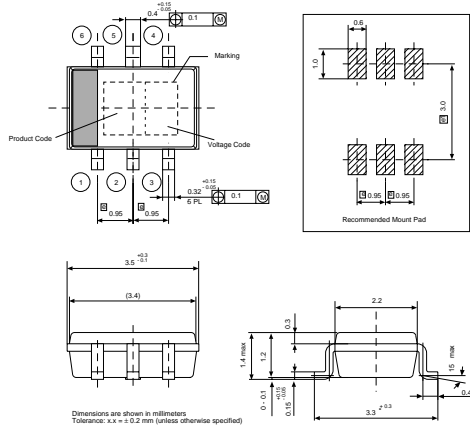

Note: Pin 2 and Pin 5 should be grounded for heat dissipation

Marking Information

Product Code P
Voltage Code

TK11213B	13
TK11214B	14
TK11215B	15
TK11216B	16
TK11217B	17
TK11218B	18
TK11219B	19
TK11220B	20
TK11221B	21
TK11222B	22
TK11223B	23
TK11224B	24
TK11225B	25
TK11226B	26
TK11227B	27
TK11228B	28
TK11229B	29
TK11230B	30
TK11231B	31
TK11232B	32
TK11233B	33
TK11234B	34
TK11235B	35
TK11236B	36
TK11237B	37
TK11238B	38
TK11239B	39
TK11240B	40
TK11241B	41
TK11242B	42
TK11243B	43
TK11244B	44
TK11245B	45
TK11246B	46
TK11247B	47
TK11248B	48
TK11249B	49
TK11250B	50
TK11255B	55
TK11280B	80

SOT-89 (SOT 89-5)

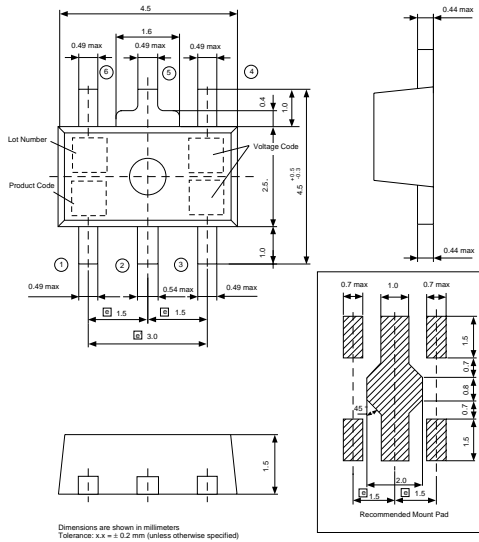

Toko America, Inc. Headquarters
1250 Feehanville Drive, Mount Prospect, Illinois 60056
Tel: (847) 297-0070 Fax: (847) 699-7864

TOKO AMERICA REGIONAL OFFICES

Midwest Regional Office
Toko America, Inc.
1250 Feehanville Drive
Mount Prospect, IL 60056
Tel: (847) 297-0070
Fax: (847) 699-7864

Western Regional Office
Toko America, Inc.
2480 North First Street, Suite 260
San Jose, CA 95131
Tel: (408) 432-8281
Fax: (408) 943-9790

Eastern Regional Office
Toko America, Inc.
107 Mill Plain Road
Danbury, CT 06811
Tel: (203) 748-6871
Fax: (203) 797-1223

Semiconductor Technical Support
Toko Design Center
4755 Forge Road
Colorado Springs, CO 80907
Tel: (719) 528-2200
Fax: (719) 528-2375

Visit our Internet site at <http://www.tokoam.com>