

- ◇ STRUCTURE                      Silicon Monolithic Integrated Circuit
- ◇ PRODUCT                        Microwire BUS 1Kbit(64 × 16bit) EEPROM
- ◇ PART NUMBER                **BR93L46-W Series**

PART NUMBER	PACKAGE
BR93L46F-W	SOP8
BR93L46RF-W	SOP8
BR93L46FJ-W	SOP-J8
BR93L46RFJ-W	SOP-J8
BR93L46FV-W	SSOP-B8
BR93L46RFV-W	SSOP-B8
BR93L46FVT-W	TSSOP-B8
BR93L46RFVT-W	TSSOP-B8
BR93L46RFVM-W	MSOP8
BR93L46RFVJ-W	TSSOP-B8J

- ◇ FEATURES                      Microwire BUS EEPROM
- Wide operating supply voltage range(1.8V~5.5V)
- 1,000,000 erase/write cycles endurance

◇ ABSOLUTE MAXIMUM RATING (Ta=25°C)

Parameter	Symbol	Rating	Unit
Supply Voltage	Vcc	-0.3~6.5	V
Power Dissipation	Pd	450 (BR93L46F-W) *1	mW
		450 (BR93L46RF-W) *2	
		450 (BR93L46FJ-W) *3	
		450 (BR93L46RFJ-W) *4	
		300 (BR93L46FV-W) *5	
		300 (BR93L46RFV-W) *6	
		330 (BR93L46FVT-W) *7	
		330 (BR93L46RFVT-W) *8	
		310 (BR93L46RFVM-W) *9	
		310 (BR93L46RFVJ-W) *10	
Storage Temperature	Tstg	-65~125	°C
Operating Temperature	Topr	-40~85	°C
Terminal Voltage	—	-0.3~Vcc+0.3	V

\* Degradation is done at 4.5mW/°C (\*1,\*2,\*3,\*4), 3.0mW/°C(\*5,\*6), 3.3mW/°C(\*7,\*8), 3.1mW/°C(\*9,\*10) for operation above 25°C

◇ RECOMMENDED OPERATING CONDITION

Parameter	Symbol	Rating	Unit
Supply Voltage	Vcc	1.8~5.5	V
Input Voltage	VIN	0~Vcc	V

Status of this document

The Japanese version of this document is the formal specification.

A customer may use this translation version only for a reference to help reading the formal version.

If there are any differences in translation version of this document, formal version takes priority.

◇ MEMORY CELL CHARACTERISTICS (Ta=25°C, Vcc=1.8~5.5V)

Parameter	Specification	Unit		
		Min.	Typ.	Max
Erase/Write Cycle *1	1,000,000	-	-	Cycles
Data Retention *1	40	-	-	Years

○Initial Data FFFFh in all address. \*1 Not 100% TESTED

◇ DC OPERATING CHARACTERISTICS  
(Unless otherwise specified Ta=-40~85°C, Vcc=1.8~5.5V)

Parameter	Symbol	Specification			Unit	Test Condition
		Min.	Typ.	Max		
"L" Input Voltage1	VIL1	-0.3	-	0.8	V	4.0 ≤ Vcc ≤ 5.5
"L" Input Voltage2	VIL2	-0.3	-	0.2 × Vcc	V	1.8 ≤ Vcc ≤ 4.0
"H" Input Voltage1	VIH1	2.0	-	Vcc+0.3	V	4.0 ≤ Vcc ≤ 5.5
"H" Input Voltage2	VIH2	0.7 × Vcc	-	Vcc+0.3	V	1.8 ≤ Vcc ≤ 4.0
"L" Output Voltage1	VOL1	0	-	0.4	V	IOL=2.1mA, 4.0 ≤ Vcc ≤ 5.5
"L" Output Voltage2	VOL2	0	-	0.2	V	IOL=100 μA, 1.8 ≤ Vcc ≤ 4.0
"H" Output Voltage1	VOH1	2.4	-	Vcc	V	IOH=-0.4mA, 4.0 ≤ Vcc ≤ 5.5
"H" Output Voltage2	VOH2	Vcc-0.2	-	Vcc	V	IOH=-100 μA, 1.8 ≤ Vcc ≤ 4.0
Input Leakage Current	ILI	-1	-	1	μA	VIN=0~Vcc
Output Leakage Current	ILO	-1	-	1	μA	VOUT=0~Vcc, CS=0V
Operating Current	ICC1	-	-	3.0	mA	fSK=2MHz, tE/W=5ms (WRITE)
	ICC2	-	-	1.5	mA	fSK=2MHz (READ)
	ICC3	-	-	4.5	mA	fSK=2MHz, tE/W=5ms (WRALERAL)
	ICC4	-	-	1.5	mA	fSK=500kHz, tE/W=5ms (WRITE)
	ICC5	-	-	0.5	mA	fSK=500kHz (READ)
	ICC6	-	-	2	mA	fSK=500kHz (WRALERAL)
Standby Current	ISB	-	-	2	μA	CS=0V, DO=OPEN

◇ AC OPERATING CHARACTERISTICS  
(Unless otherwise specified Ta=-40~85°C, Vcc=1.8~5.5V)

Parameter	Symbol	1.8V ≤ Vcc ≤ 2.5V			Unit	2.5V ≤ Vcc ≤ 5.5V			Unit
		Min.	Typ.	Max		Min.	Typ.	Max	
SK Clock Frequency	fSK	0	-	500	kHz	-	-	2	MHz
SK High Time	tSKH	0.8	-	-	μs	230	-	-	ns
SK Low Time	tSKL	0.8	-	-	μs	230	-	-	ns
CS Low Time	tCS	1	-	-	μs	200	-	-	ns
CS Setup Time	tCSS	200	-	-	ns	50	-	-	ns
DI Setup Time	tDIS	100	-	-	ns	100	-	-	ns
CS Hold Time	tCSH	0	-	-	ns	0	-	-	ns
DI Hold Time	tDIH	100	-	-	ns	100	-	-	ns
Data "1" Output Delay Time	tPD1	-	-	0.7	μs	-	-	200	ns
Data "0" Output Delay Time	tPD0	-	-	0.7	μs	-	-	200	ns
CS to Status Valid	tSV	-	-	0.7	μs	-	-	150	ns
CS to Output High-Z	tDF	-	-	200	ns	-	-	150	ns
Write Cycle time	tE/W	-	-	5	ms	-	-	5	ms

○This product is not designed for protection against radioactive rays.

◇ BLOCK DIAGRAM

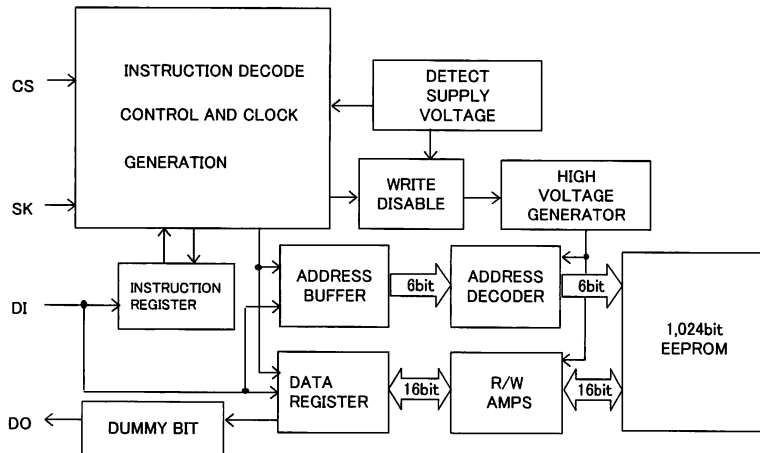

Fig.-1 BLOCK DIAGRAM

◇ PIN No. / PIN NAME

PIN No.	PIN NAME	
1	CS	N.C.
2	SK	Vcc
3	DI	CS
4	DO	SK
5	GND	DI
6	N.C.	DO
7	N.C.	GND
8	Vcc	N.C.
PART NUMBER	BR93L46RF-W	BR93L46F-W
	BR93L46RFJ-W	BR93L46FJ-W
	BR93L46RFV-W	BR93L46FV-W
	BR93L46RFVT-W	BR93L46FVT-W
	BR93L46RFVJ-W	

◇ NOTES FOR POWER SUPPLY

This IC has a POR (Power On Reset) circuit as mistake write countermeasure.

After POR action, it gets in write disable status. The POR circuit is valid only when power is ON, and does not work when power is OFF. However, if CS is "H" at power ON/OFF, it may become write enable status owing to noises and the likes. For secure operations, observe the following conditions.

1. Set CS = "L".
2. Turn on power so as to satisfy the recommended conditions of  $t_R$ ,  $t_{OFF}$ ,  $V_{bot}$  for POR circuit operation.

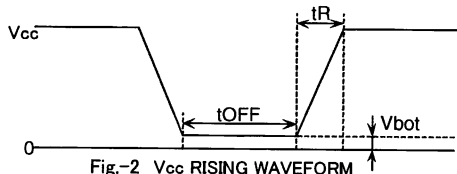

◇ Recommended conditions of  $t_R$ ,  $t_{OFF}$ ,  $V_{bot}$

$t_R$	$t_{OFF}$	$V_{bot}$
Below 10ms	Above 10ms	Below 0.3V
Below 100ms	Above 10ms	Below 0.2V

◇ CAUTIONS ON USE

(1) Absolute Maximum Ratings

If the absolute maximum ratings such as impressed voltage and action temperature range and so forth are exceeded, LSI may be destructed. Do not impress voltage and temperature exceeding the absolute maximum ratings. In the case of fear exceeding the absolute maximum ratings, take physical safety countermeasures such as fuses, and see to it that conditions exceeding the absolute maximum ratings should not be impressed to LSI.

(2) GND electric potential

Set the voltage of GND terminal lowest at any action condition. Make sure that each terminal voltage is not lower than that of GND terminal in consideration of transition status.

(3) Heat design

In consideration of allowable loss in actual use condition, carry out heat design with sufficient margin.

(4) Terminal to terminal shortcircuit and wrong packaging

When to package LSI onto a board, pay sufficient attention to LSI direction and displacement. Wrong packaging may destruct LSI. And in the case of shortcircuit between LSI terminals and terminals and power source, terminal and GND owing to foreign matter, LSI may be destructed.

(5) Use in a strong electromagnetic field may cause malfunction, therefore , evaluated design sufficiently.

◇PHYSICAL DIMENSION

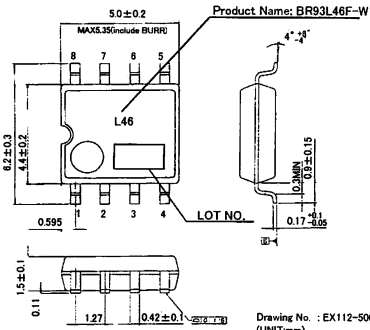

Fig4-(a) PHYSICAL DIMENSION SOP8 (BR93L46F-W)

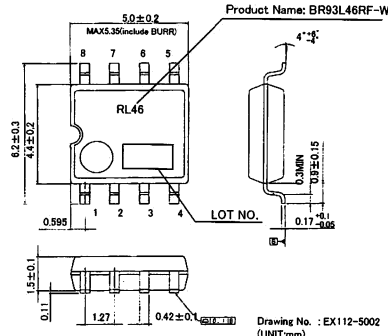

Fig4-(b) PHYSICAL DIMENSION SOP8 (BR93L46RF-W)

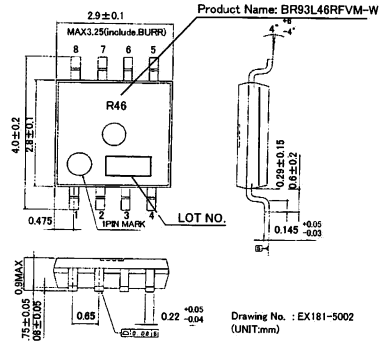

Fig4-(c) PHYSICAL DIMENSION MSOP8 (BR93L46RFVM-W)

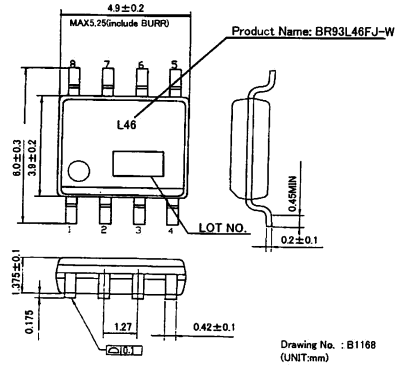

Fig4-(d) PHYSICAL DIMENSION SOP-8J (BR93L46FJ-W)

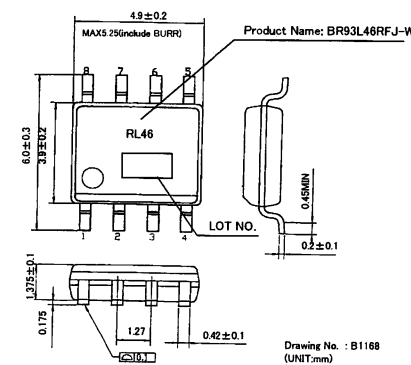

Fig4-(e) PHYSICAL DIMENSION SOP-8J (BR93L46RFJ-W)

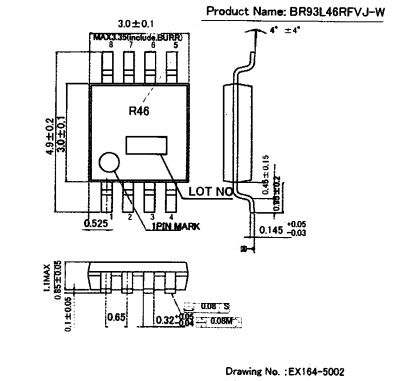

Fig4-(f) PHYSICAL DIMENSION TSSOP-B8J (BR93L46RFVJ-W)

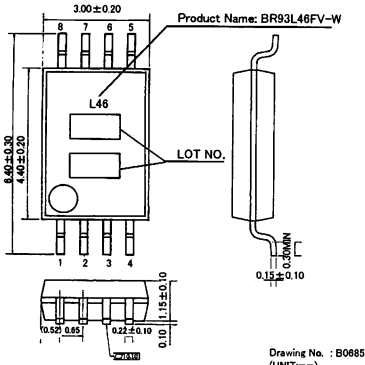

Fig4-(g) PHYSICAL DIMENSION SSOP-B8 (BR93L46FV-W)

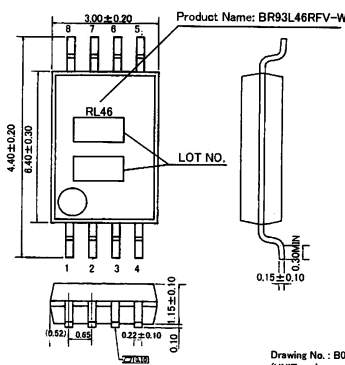

Fig4-(h) PHYSICAL DIMENSION SSOP-B8 (BR93L46RFV-W)

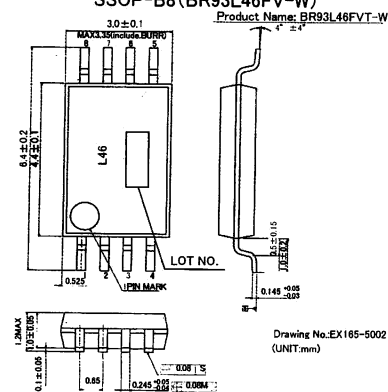

Fig4-(i) PHYSICAL DIMENSION TSSOP-B8 (BR93L46FVT-W)

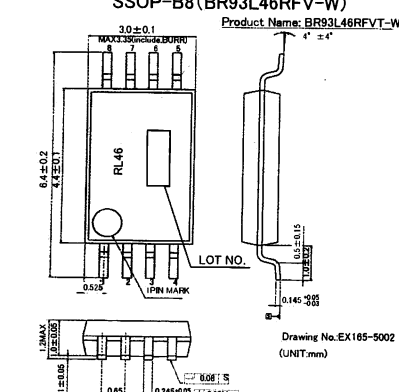

Fig4-(j) PHYSICAL DIMENSION TSSOP-B8 (BR93L46RFVT-W)

### Notes

- No technical content pages of this document may be reproduced in any form or transmitted by any means without prior permission of ROHM CO.,LTD.
- The contents described herein are subject to change without notice. The specifications for the product described in this document are for reference only. Upon actual use, therefore, please request that specifications to be separately delivered.
- Application circuit diagrams and circuit constants contained herein are shown as examples of standard use and operation. Please pay careful attention to the peripheral conditions when designing circuits and deciding upon circuit constants in the set.
- Any data, including, but not limited to application circuit diagrams information, described herein are intended only as illustrations of such devices and not as the specifications for such devices. ROHM CO.,LTD. disclaims any warranty that any use of such devices shall be free from infringement of any third party's intellectual property rights or other proprietary rights, and further, assumes no liability of whatsoever nature in the event of any such infringement, or arising from or connected with or related to the use of such devices.
- Upon the sale of any such devices, other than for buyer's right to use such devices itself, resell or otherwise dispose of the same, no express or implied right or license to practice or commercially exploit any intellectual property rights or other proprietary rights owned or controlled by
- ROHM CO., LTD. is granted to any such buyer.
- Products listed in this document are no antiradiation design.

The products listed in this document are designed to be used with ordinary electronic equipment or devices (such as audio visual equipment, office-automation equipment, communications devices, electrical appliances and electronic toys).

Should you intend to use these products with equipment or devices which require an extremely high level of reliability and the malfunction of which would directly endanger human life (such as medical instruments, transportation equipment, aerospace machinery, nuclear-reactor controllers, fuel controllers and other safety devices), please be sure to consult with our sales representative in advance.

#### About Export Control Order in Japan

Products described herein are the objects of controlled goods in Annex 1 (Item 16) of Export Trade Control Order in Japan.

In case of export from Japan, please confirm if it applies to "objective" criteria or an "informed" (by MITI clause) on the basis of "catch all controls for Non-Proliferation of Weapons of Mass Destruction.

Thank you for your accessing to ROHM product informations.  
More detail product informations and catalogs are available,  
please contact your nearest sales office.

Please contact our sales offices for details ;

U.S.A / San Diego	TEL : +1(858)625-3630	FAX : +1(858)625-3670
Atlanta	TEL : +1(770)754-5972	FAX : +1(770)754-0691
Dallas	TEL : +1(972)312-8818	FAX : +1(972)312-0330
Germany / Dusseldorf	TEL : +49(2154)9210	FAX : +49(2154)921400
United Kingdom / London	TEL : +44(1)908-282-666	FAX : +44(1)908-282-528
France / Paris	TEL : +33(0)1 56 97 30 60	FAX : +33(0) 1 56 97 30 80
China / Hong Kong	TEL : +852(2)740-6262	FAX : +852(2)375-8971
Shanghai	TEL : +86(21)6279-2727	FAX : +86(21)6247-2066
Dilian	TEL : +86(411)8230-8549	FAX : +86(411)8230-8537
Beijing	TEL : +86(10)8525-2483	FAX : +86(10)8525-2489
Taiwan / Taipei	TEL : +866(2)2500-6956	FAX : +866(2)2503-2869
Korea / Seoul	TEL : +82(2)8182-700	FAX : +82(2)8182-715
Singapore	TEL : +65-6332-2322	FAX : +65-6332-5662
Malaysia / Kuala Lumpur	TEL : +60(3)7958-8355	FAX : +60(3)7958-8377
Philippines / Manila	TEL : +63(2)807-6872	FAX : +63(2)809-1422
Thailand / Bangkok	TEL : +66(2)254-4890	FAX : +66(2)256-6334

Japan /  
(Internal Sales)

Tokyo	2-1-1, Yaesu, Chuo-ku, Tokyo 104-0082	TEL : +81(3)5203-0321	FAX : +81(3)5203-0300
Yokohama	2-4-8, Shin Yokohama, Kohoku-ku, Yokohama, Kanagawa 222-8575	TEL : +81(45)476-2131	FAX : +81(45)476-2128
Nagoya	Dainagayo Building 9F 3-28-12, Meieki, Nakamura-ku, Nagoya, Aichi 450-0002	TEL : +81(52)581-8521	FAX : +81(52)561-2173
Kyoto	579-32 Higashi Shiokouji-cho, Karasuma Nishi-iru, Shiokoujidori, Shimogyo-ku, Kyoto 600-8216	TEL : +81(75)311-2121	FAX : +81(75)314-6559

(Contact address for overseas customers in Japan)

Yokohama	TEL : +81(45)476-9270	FAX : +81(045)476-9271
----------	-----------------------	------------------------