

**TRIGGER APPLICATION**  
**LEAD MOUNT TYPE, PLANE-MOUNTED TYPE (SC-59 OUTLINE)**

**DESCRIPTION**

BS08D, BS08E is a silicon planer transistor, bilateral switching integrated circuit. It is suitable for trigger application of thyristor.

**FEATURE**

- Low switching voltage  $V_s = 7$  to  $9V$
- Good switching voltage temperature coefficient  $0.01\%/^{\circ}C$
- With gate electrode, it is easy for control and synchronism of switching.

**APPLICATION**

Trigger circuit of thyristor · triac oscillator, timer.

**OUTLINE DRAWING**

Unit:mm

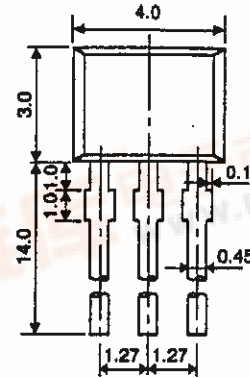

**TERMINAL CONNECTOR**

- ①: T<sub>2</sub> TERMINAL
  - ②: GATE
  - ③: T<sub>1</sub> TERMINAL
- EIAJ: —  
JEDEC: —  
(BS08D)

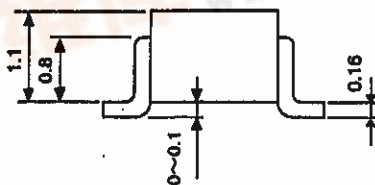
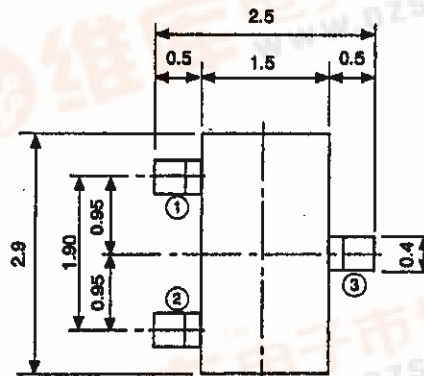

**TERMINAL CONNECTOR**

- ①: T<sub>2</sub> TERMINAL
  - ②: T<sub>1</sub> TERMINAL
  - ③: GATE
- EIAJ: SC-59  
JEDEC: TO-236 resemblance  
(BS08E)



(TRIGGER ELEMENT)

# BS08D, BS08E

TRIGGER APPLICATION  
LEAD MOUNT TYPE, PLANE-MOUNTED TYPE (SC-59 OUTLINE)

## MAXIMUM RATINGS

Symbol	Parameter	Conditions	Ratings		Unit
			BS08D	BS08E	
$I_T$	DC On Current	$T_a = 25^\circ\text{C}$	175	100	mA
—	Repetitive Peak On-Current	1% duty, $t_w = 10\mu\text{s}$ , $T_a = 100^\circ\text{C}$	1	1	A
—	Not Repetitive Peak On-Current	$t_w = 10\mu\text{s}$ , $T_a = 25^\circ\text{C}$	2	2	A
P	On-State Dissipation	$T_a = 25^\circ\text{C}$	450	150	mW
$I_g$	DC Gate Current		5		mA
$T_j$	Junction temperature		-55 to +125		$^\circ\text{C}$
$T_{stg}$	Storage temperature		-55 to +125		$^\circ\text{C}$

## ELECTRICAL CHARACTERISTICS

Symbol	Parameter	Test conditions	Limits			Unit
			Min	Typ	Max	
$V_s$	Switching voltage	$T_a = 25^\circ\text{C}$	7	8	9	V
$I_s$	Switching current	$T_a = 25^\circ\text{C}$	—	—	200	$\mu\text{A}$
$ V_{s1} - V_{s2} $	Switching voltage difference	$T_a = 25^\circ\text{C}$	—	—	0.5	V
$ I_{s1} - I_{s2} $	Switching current difference	$T_a = 25^\circ\text{C}$	—	—	100	$\mu\text{A}$
$I_H$	Holding current	$T_a = 25^\circ\text{C}$	—	—	1.5	mA
$I_D$	Off current	$V_D = 5\text{V}$ , $T_a = 25^\circ\text{C}$	—	—	1.0	$\mu\text{A}$
		$V_D = 5\text{V}$ , $T_a = 85^\circ\text{C}$	—	—	10	$\mu\text{A}$
—	Switching voltage temperature coefficient	$T_a = -55^\circ\text{C}$ to $+85^\circ\text{C}$	—	$\pm 0.01$	—	%/ $^\circ\text{C}$
$V_T$	On voltage	$I_T = 175\text{mA}$ , $T_a = 25^\circ\text{C}$	—	—	1.4	V
$I_{GT}$	Gate trigger current	$V_D = 5\text{V}$ , $T_a = 25^\circ\text{C}$	10	—	200	$\mu\text{A}$
$V_{G0}$	Gate not trigger voltage	$V_D = 5\text{V}$ , $T_a = 85^\circ\text{C}$	0.2	—	—	V

SYMBOL

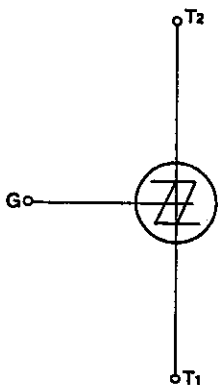

EQUIVALENT CIRCUIT

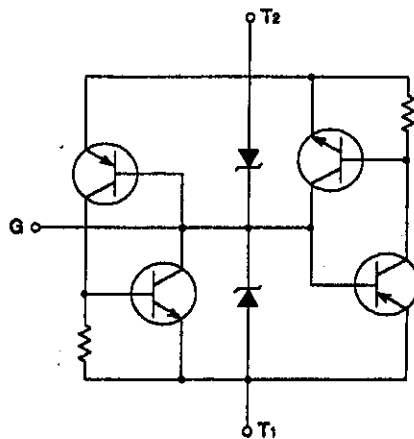

STATIC CHARACTERISTICS

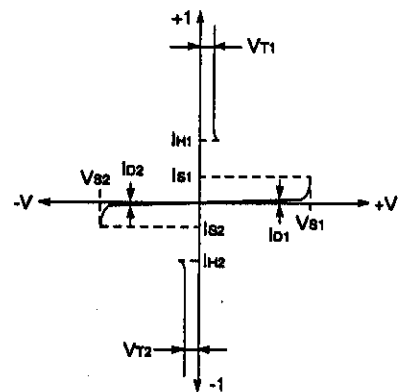

(TRIGGER ELEMENT)

BS08D, BS08E

TRIGGER APPLICATION  
LEAD MOUNT TYPE, PLANE-MOUNTED TYPE (SC-59 OUTLINE)

PERFORMANCE CURVES

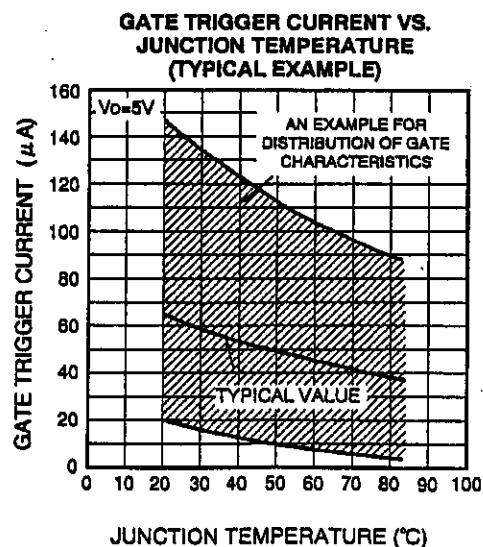
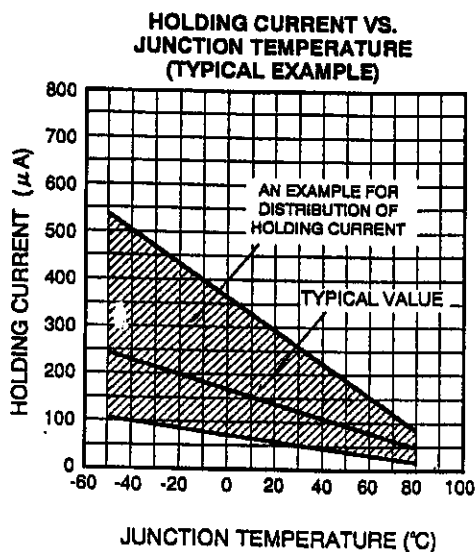
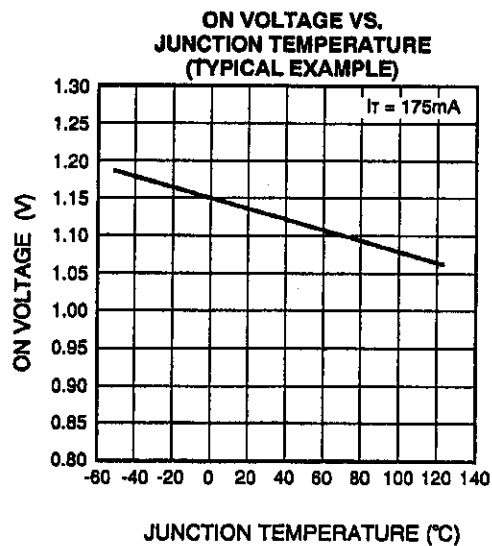
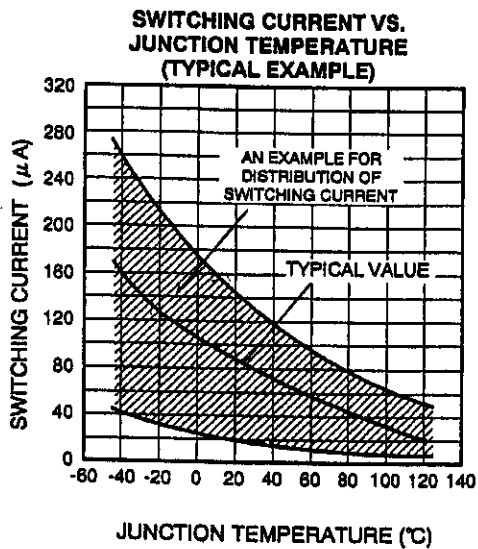
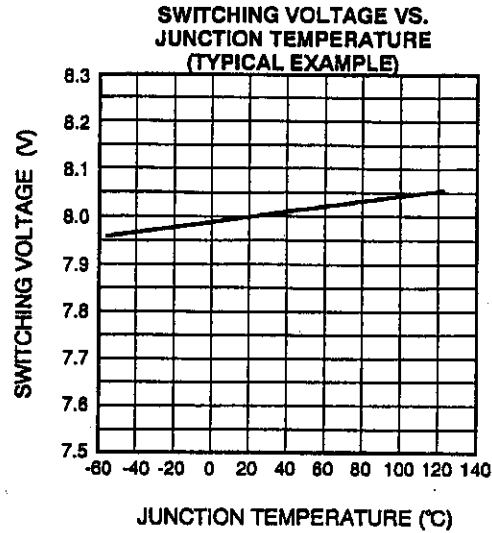
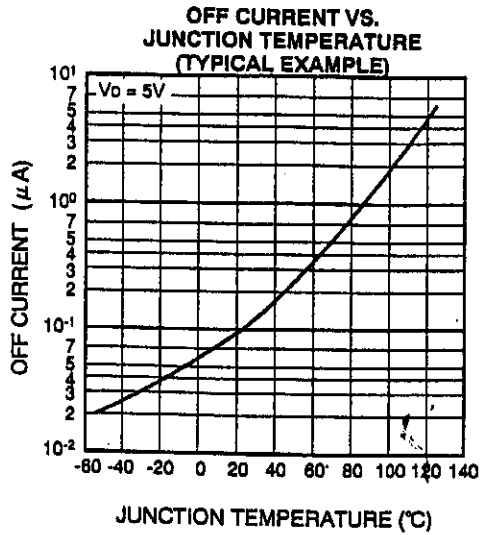

( TRIGGER ELEMENT )

# BS08D, BS08E

TRIGGER APPLICATION  
LEAD MOUNT TYPE, PLANE-MOUNTED TYPE (SC-59 OUTLINE)

GATE TRIGGER VOLTAGE VS. JUNCTION TEMPERATURE (TYPICAL EXAMPLE)

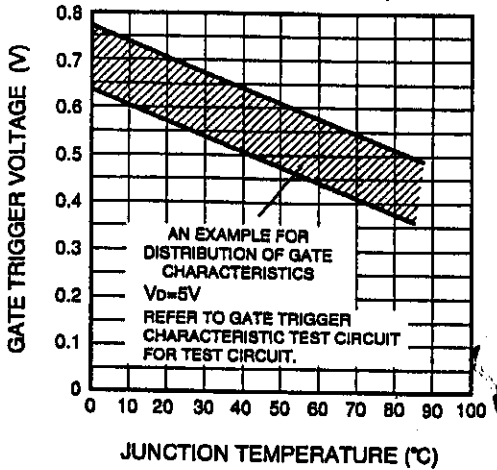

GATE TRIGGER CHARACTERISTIC TEST CIRCUIT

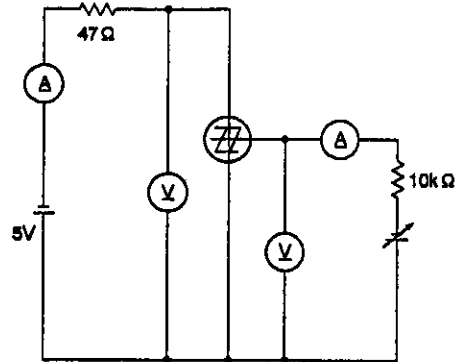

## APPLICATION EXAMPLE

THYRISTOR TRIGGER CIRCUIT

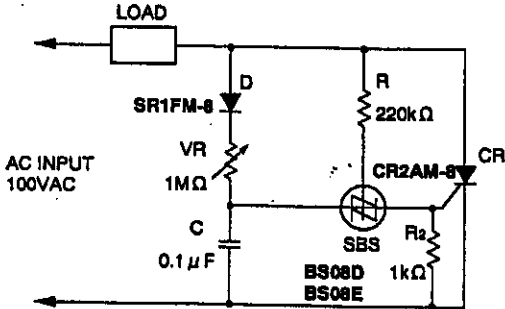

TRIAC TRIGGER CIRCUIT

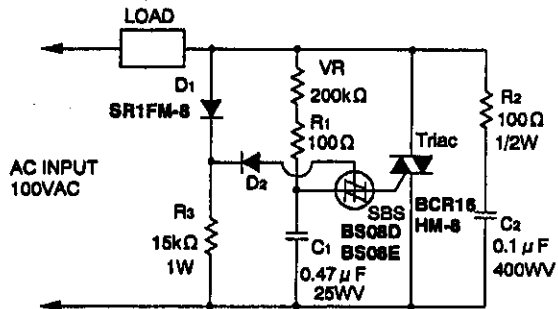

The above circuit is a thyristor phase control circuit making use of an SBS. In this circuit, using the SBS gate, the residual charge on C is reset, reducing the hysteresis characteristics. Therefore, over the range of the variable resistor, phase control (in the range 5 to 175°C) is possible, making this circuit widely useful in DC motor control and other control applications.

The above circuit is a triac phase control circuit making use of an SBS. In this circuit, an SBS gate is used to reduce the hysteresis characteristics. Thus, by using the variable resistance, phase control is possible over the wide range of 10 to 180 °C. Therefore, this circuit is widely usable in such applications as lighting control circuits, electric heater control, and other load control applications.

(TRIGGER ELEMENT)

## BS08D, BS08E

### TRIGGER APPLICATION LEAD MOUNT TYPE, PLANE-MOUNTED TYPE (SC-59 OUTLINE)

#### Constant-speed control circuit of an universal motor FEATURES

- (1) The feedback amount is automatically controlled by the motor speed for easy constant-speed operation.
- (2) The feedback amount required for each motor type can be adjusted by resistor VR<sub>2</sub>, thus enabling control of various types of motors.

#### OPERATING PRINCIPLE

The speed of motor is adjusted by VR<sub>1</sub> in the phase-shifting circuit. In the comparison circuit, the reference voltage supplied by the Zener diode and the armature voltage are compared, and C in the phase-shifting circuit is charged by the difference of voltages. The effect of feedback is negligible as the sum of VR<sub>1</sub> and C is small during high-speed operation, but, during low-speed operation, when the sum of VR<sub>1</sub> and C is large, even a small feedback is effective and constant operation is improved at low-speed operation. (Patented by Mitsubishi Electric)

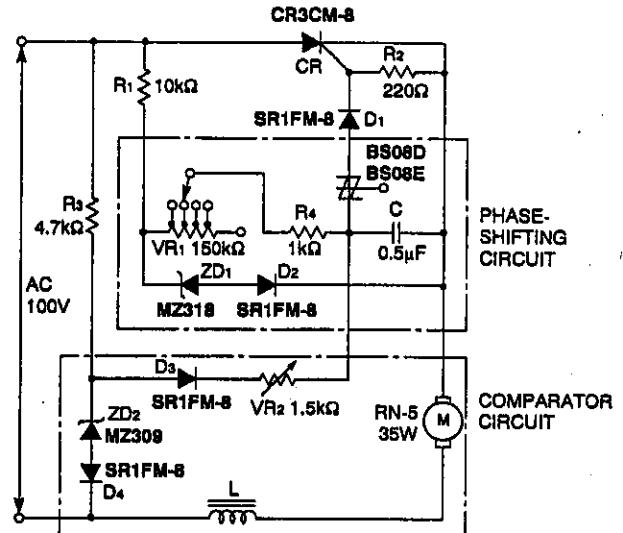

#### Gas/Petroleum Ignition circuit FEATURES

- (1) When the power supply is in the negative half cycle, spark discharge occurs. Compact and small-capacity resistor R<sub>1</sub> and a thyristor can be used as the current does not flow from the power supply of the thyristor.
- (2) High-voltage pulses of more than 14kV are output to cause certain ignition of gas or kerosine.

#### OPERATING PRINCIPLE

Capacitor C<sub>1</sub> is charged through R<sub>1</sub> and D<sub>1</sub> during the half cycle of positive power supply and C<sub>2</sub> is charged through R<sub>2</sub> using the reverse voltage applied to D<sub>1</sub>. In this case, R<sub>1</sub>, R<sub>2</sub>, C<sub>1</sub> and C<sub>2</sub> should be selected to make R<sub>1</sub> C<sub>1</sub> << R<sub>2</sub> C<sub>2</sub>. SBS is turned on as C<sub>2</sub> reaches the switching voltage after C<sub>1</sub> is fully charged, and the gate current flows to the thyristor CR. The electric charge charged in C<sub>1</sub> is instantly discharged through CR. The electric charge charged with the reverse polarity, it is discharged again through D<sub>2</sub> and the coil, and then C<sub>1</sub> is charged again with the original polarity. Thus high voltage is generated (more than 14kV) on the secondary side of the coil by the current flowing through the coil to produce spark discharge at the discharge gap.

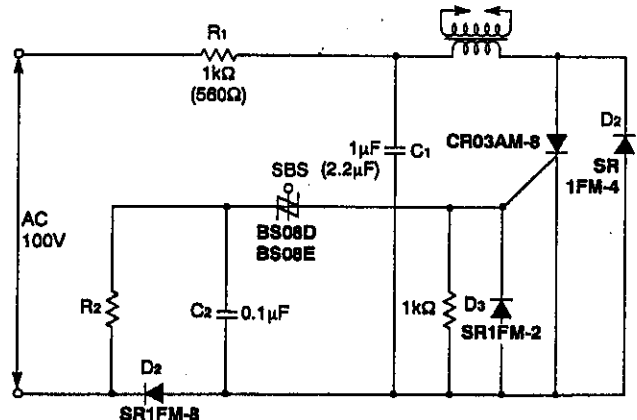

GAS IGNITION UNIT..... R<sub>1</sub>=1kΩ, C<sub>1</sub>=1μF  
PETROLEUM IGNITION UNIT..... R<sub>1</sub>=560Ω, C<sub>1</sub>=2.2μF

#### Electric foot warmer (kotatsu) FEATURES

Non-stage and wide-range control of the temperature of kotatsu is possible.

#### OPERATING PRINCIPLE

The temperature is controlled by trigger pulses generated by VR, PTh, R<sub>1</sub>, BM, R<sub>2</sub> and C<sub>4</sub> and by the control of the trigger phase of triac BCR. If the temperature exceeds a specified value after the temperature is set by VR, the resistive value of positive-type thermistor PTh increases and the conductive angle of BCR becomes smaller and so the temperature falls. If the value decreases, the conductive angle becomes larger and the temperature rises.

The bimetal switch BM detects sudden temperature rises and turns the BCR to an off state and stops the power supply. R<sub>2</sub> is provided to prevent re-triggering of SBS.

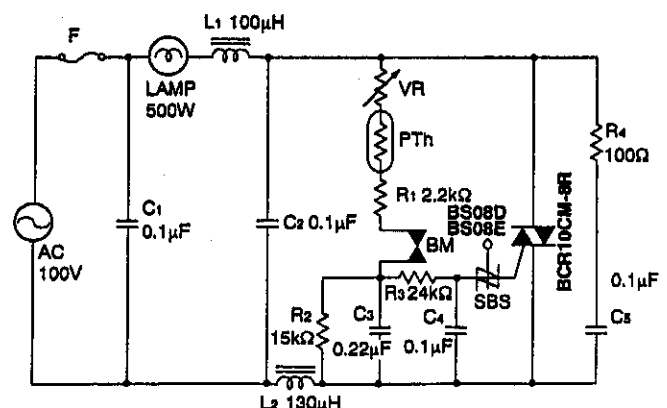

(TRIGGER ELEMENT)

# BS08D,BS08E

## TRIGGER APPLICATION LEAD MOUNT TYPE, PLANE-MOUNTED TYPE (SC-59 OUTLINE)

Example of a basic phase control circuit using BS08D,BS08E and BCR (or CR)

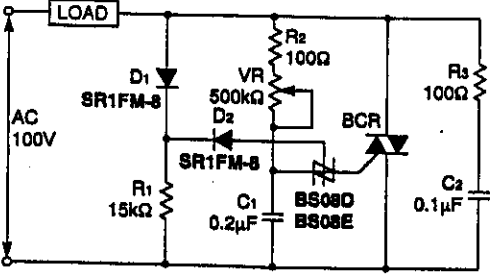
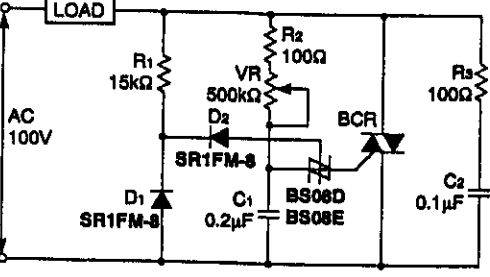
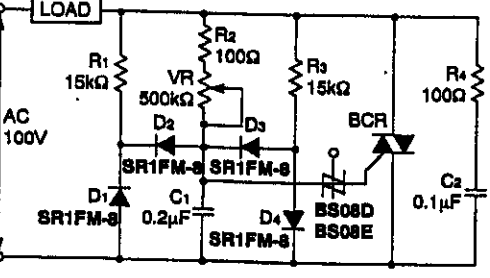
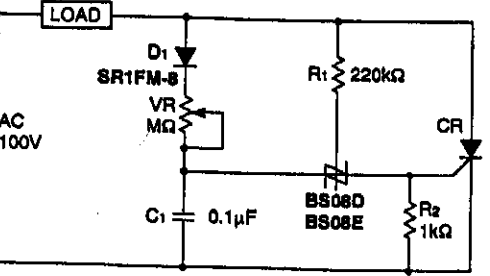
Circuit diagram	Features	Operating principle
 <p>AC 100V</p> <p>LOAD</p> <p>R<sub>1</sub> 15kΩ</p> <p>D<sub>1</sub> SR1FM-8</p> <p>VR 500kΩ</p> <p>D<sub>2</sub> SR1FM-8</p> <p>R<sub>2</sub> 100Ω</p> <p>C<sub>1</sub> 0.2μF</p> <p>BS08D BS08E</p> <p>R<sub>3</sub> 100Ω</p> <p>C<sub>2</sub> 0.1μF</p> <p>BCR</p>	<ul style="list-style-type: none"> <li>• Smooth control is possible in the range of 5 to 99% of the load power supply for AC input voltage.</li> <li>• Suitable for resistive load.</li> <li>• Phase control range is 10 to 150°</li> </ul>	<p>The triac BCR trigger phase is controlled by the CR phase-shifting circuit consisting of VR and C<sub>1</sub>, and hysteresis is reduced by D<sub>1</sub>,D<sub>2</sub>,R<sub>1</sub> and the gate of BS08D,BS08E.</p>
<p>BCR : Triacs of 1A to 30A class can be used.</p>  <p>AC 100V</p> <p>LOAD</p> <p>R<sub>1</sub> 15kΩ</p> <p>VR 500kΩ</p> <p>D<sub>2</sub> SR1FM-8</p> <p>R<sub>2</sub> 100Ω</p> <p>C<sub>1</sub> 0.2μF</p> <p>BS08D BS08E</p> <p>R<sub>3</sub> 100Ω</p> <p>C<sub>2</sub> 0.1μF</p> <p>BCR</p>	<ul style="list-style-type: none"> <li>• Smooth control is possible in the range of 5 to 99% of the load power supply for AC input voltage.</li> <li>• Suitable for resistive load.</li> <li>• Phase control range is 10 to 150°</li> </ul>	<p>The triac BCR trigger phase is controlled by the CR phase-shifting circuit consisting of VR and C<sub>1</sub>, and hysteresis is reduced by D<sub>1</sub>,D<sub>2</sub>,R<sub>1</sub> and the gate of BS08D,BS08E.</p>
<p>BCR : Triacs of 1A to 30A class can be used.</p>  <p>AC 100V</p> <p>LOAD</p> <p>R<sub>1</sub> 15kΩ</p> <p>VR 500kΩ</p> <p>D<sub>2</sub> SR1FM-8</p> <p>R<sub>2</sub> 100Ω</p> <p>C<sub>1</sub> 0.2μF</p> <p>BS08D BS08E</p> <p>R<sub>3</sub> 15kΩ</p> <p>D<sub>3</sub> SR1FM-8</p> <p>R<sub>4</sub> 100Ω</p> <p>C<sub>2</sub> 0.1μF</p> <p>BCR</p>	<ul style="list-style-type: none"> <li>• Smooth control is possible in the range of 5 to 99% of the load power supply for AC input voltage.</li> <li>• Suitable for inductive load.</li> <li>• Phase control range is 10 to 150°</li> </ul>	<p>The triac BCR trigger phase is controlled by the CR phase-shifting circuit consisting of VR and C<sub>1</sub>, and hysteresis is reduced by D<sub>1</sub>,D<sub>2</sub>,D<sub>3</sub>,D<sub>4</sub>,R<sub>1</sub>,R<sub>3</sub>.</p>
<p>CR : Thyristors of 0.3A to 20A class can be used.</p>  <p>AC 100V</p> <p>LOAD</p> <p>D<sub>1</sub> SR1FM-8</p> <p>VR MQ</p> <p>C<sub>1</sub> 0.1μF</p> <p>BS08D BS08E</p> <p>R<sub>1</sub> 220kΩ</p> <p>R<sub>2</sub> 1kΩ</p> <p>CR</p>	<ul style="list-style-type: none"> <li>• Smooth control is possible in the range of 1 to 99% of the load power supply for AC input voltage.</li> <li>• Suitable for both resistive and inductive loads.</li> <li>• Phase control range is 10 to 170°</li> </ul>	<p>The thyristor CR trigger phase is controlled by the CR phase-shifting circuit consisting of VR and C<sub>1</sub>. The voltage of C<sub>1</sub> is reset and hysteresis is reduced by applying the gate current of BS08D,BS08E to C<sub>1</sub>, and by switching the BS08D,BS08E, applying the gate, R<sub>1</sub>, load, power supply and circuit C<sub>1</sub>.</p>

(TRIGGER ELEMENT)

**BS08D, BS08E**

**TRIGGER APPLICATION  
LEAD MOUNT TYPE, PLANE-MOUNTED TYPE (SC-59 OUTLINE)**

**Electric starter for fluorescent lamps**

**FEATURES**

Employment of a non-linear saturable capacitor, triac and reverse-blocking two-terminal thyristor provides a cheap, compact and light-weight electric starter for fluorescent lamp with short turn-on time.

**OPERATING PRINCIPLE**

If the power supply switch is turned on, the bilateral switching device Q1 is set on at a proper phase  $\theta_1$  of the positive half cycle of the power supply at the early stage of startup, and triac Q2 is triggered. If Q2 is turned on, non-linear saturable capacitor C1 with charge saturation characteristic under a specified charge voltage is charged quickly by the power supply through the stabilizer with polarity as illustrated.

C1 enters quickly into the saturation area and the current flowing to the stabilizer decreases instantly, and the high-voltage pulses of  $e = L (di/dt)$  are generated in the stabilizer. The reverse-blocking two-terminal thyristor Q3 is triggered by this pulse, and a pre-

heating current flows to the filament of the fluorescent lamp. The conducting current of Q3 becomes zero at the phase  $\theta_2$  of the negative half cycle of power supply, and Q3 is turned off. Then, the near-the-peak voltage of the negative half cycle of the supply voltage is suddenly applied at both ends of the fluorescent lamp, Q1 and Q2 are turned on again and C1 is charged quickly, with the reverse polarity as illustrated. With the same mechanism, high-voltage pulses (about 1.5kV) with the reverse polarity are generated in the stabilizer and the turn-on pulse is applied at both ends of the fluorescent lamp.

Then the same operation continues and the light is turned on if the filament is sufficiently heated. (Approximately 0.5 seconds after the power is supplied.) If the lamp is turned on, the voltage applied at both ends of the lamp decrease, and Q1, Q2 and Q3 are set off. Then preheating and high voltage pulses are stopped.

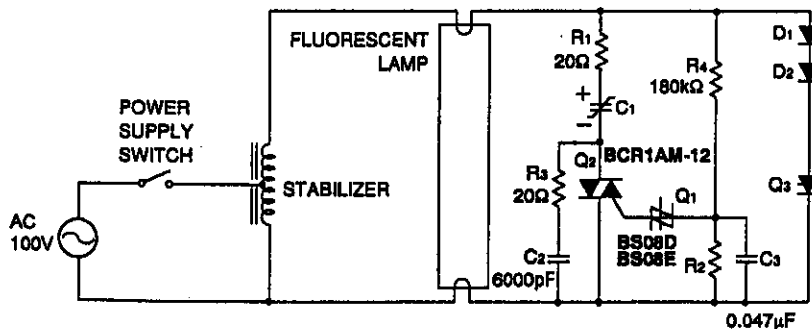

(CIRCUIT CONSTANTS ARE USED FOR 32W TYPE)

(TRIGGER ELEMENT)

## BS08D, BS08E

TRIGGER APPLICATION  
LEAD MOUNT TYPE, PLANE-MOUNTED TYPE (SC-59 OUTLINE)

### DESCRIPTION

BS08D, BS08E is a silicon planer transistor, bilateral switching integrated circuit. It is suitable for trigger application of thyristor.

### FEATURE

- Low switching voltage  $V_s \approx 7$  to  $9V$
- Good switching voltage temperature coefficient  $0.01\%/^{\circ}C$
- With gate electrode, it is easy for control and synchronism of switching.

### APPLICATION

Trigger circuit of thyristor • triac oscillator, timer.

### OUTLINE DRAWING

Unit:mm

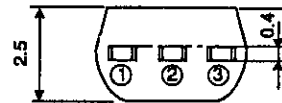
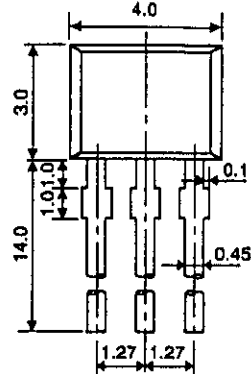

#### TERMINAL CONNECTOR

- ① : T<sub>2</sub> TERMINAL  
② : GATE  
③ : T<sub>1</sub> TERMINAL
- EIAJ : —  
JEDEC : —
- (BS08D)

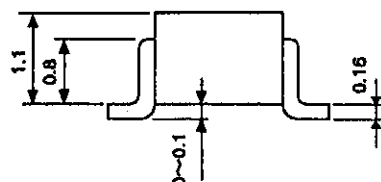
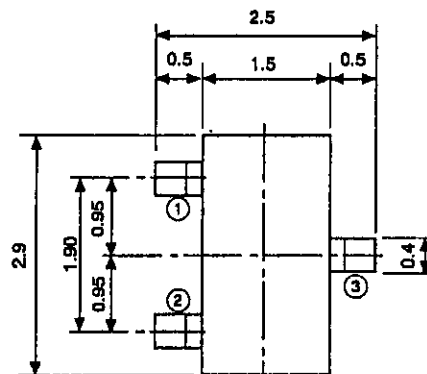

#### TERMINAL CONNECTOR

- ① : T<sub>2</sub> TERMINAL  
② : T<sub>1</sub> TERMINAL  
③ : GATE
- EIAJ : SC-59  
JEDEC : TO-238 resemblance
- (BS08E)



(TRIGGER ELEMENT)

# BS08D, BS08E

TRIGGER APPLICATION  
LEAD MOUNT TYPE, PLANE-MOUNTED TYPE (SC-59 OUTLINE)

## MAXIMUM RATINGS

Symbol	Parameter	Conditions	Ratings		Unit
			BS08D	BS08E	
$I_T$	DC On Current	$T_a = 25^\circ\text{C}$	175	100	mA
—	Repetitive Peak On-Current	1% duty, $t_w=10\mu\text{s}$ , $T_a = 100^\circ\text{C}$	1	1	A
—	Not Repetitive Peak On-Current	$t_w=10\mu\text{s}$ , $T_a = 25^\circ\text{C}$	2	2	A
P	On-State Dissipation	$T_a = 25^\circ\text{C}$	450	150	mW
$I_g$	DC Gate Current		5		mA
$T_j$	Junction temperature		-55 to +125		$^\circ\text{C}$
$T_{stg}$	Storage temperature		-55 to +125		$^\circ\text{C}$

## ELECTRICAL CHARACTERISTICS

Symbol	Parameter	Test conditions	Limits			Unit
			Min	Typ	Max	
$V_s$	Switching voltage	$T_a = 25^\circ\text{C}$	7	8	9	V
$I_s$	Switching current	$T_a = 25^\circ\text{C}$	—	—	200	$\mu\text{A}$
$ V_{s1}-V_{s2} $	Switching voltage difference	$T_a = 25^\circ\text{C}$	—	—	0.5	V
$ I_{s1}-I_{s2} $	Switching current difference	$T_a = 25^\circ\text{C}$	—	—	100	$\mu\text{A}$
$I_H$	Holding current	$T_a = 25^\circ\text{C}$	—	—	1.5	mA
$I_o$	Off current	$V_D = 5\text{V}$ , $T_a = 25^\circ\text{C}$	—	—	1.0	$\mu\text{A}$
		$V_D = 5\text{V}$ , $T_a = 85^\circ\text{C}$	—	—	10	
—	Switching voltage temperature coefficient	$T_a = -55^\circ\text{C}$ to $+85^\circ\text{C}$	—	$\pm 0.01$	—	$\%/^\circ\text{C}$
$V_T$	On voltage	$I_T = 175\text{mA}$ , $T_a = 25^\circ\text{C}$	—	—	1.4	V
$I_{GT}$	Gate trigger current	$V_D = 5\text{V}$ , $T_a = 25^\circ\text{C}$	10	—	200	$\mu\text{A}$
$V_{GD}$	Gate not trigger voltage	$V_D = 5\text{V}$ , $T_a = 85^\circ\text{C}$	0.2	—	—	V

SYMBOL

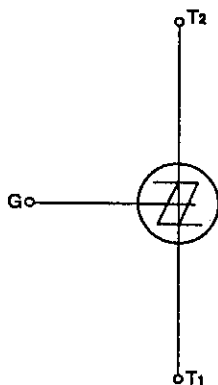

EQUIVALENT CIRCUIT

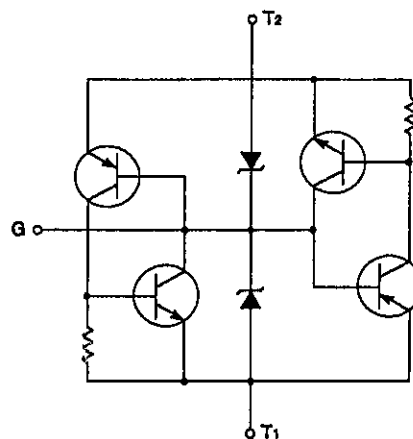

STATIC CHARACTERISTICS

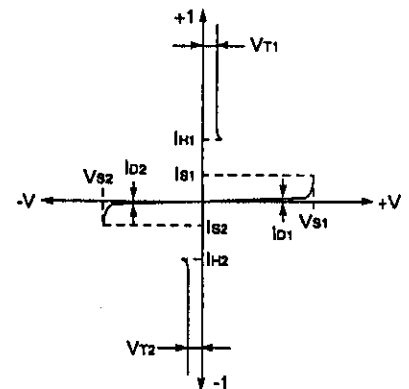

(TRIGGER ELEMENT)

# BS08D, BS08E

TRIGGER APPLICATION  
LEAD MOUNT TYPE, PLANE-MOUNTED TYPE (SC-59 OUTLINE)

## PERFORMANCE CURVES

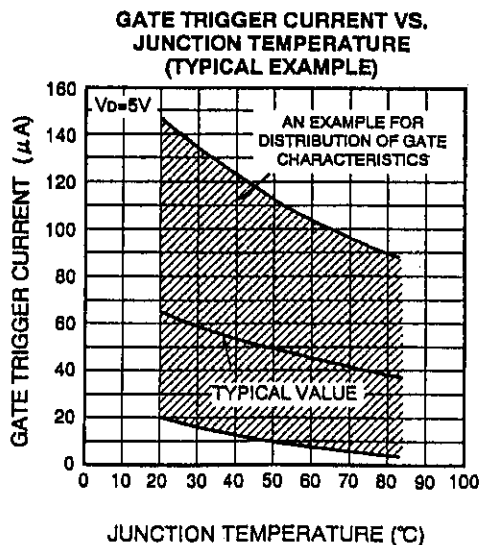
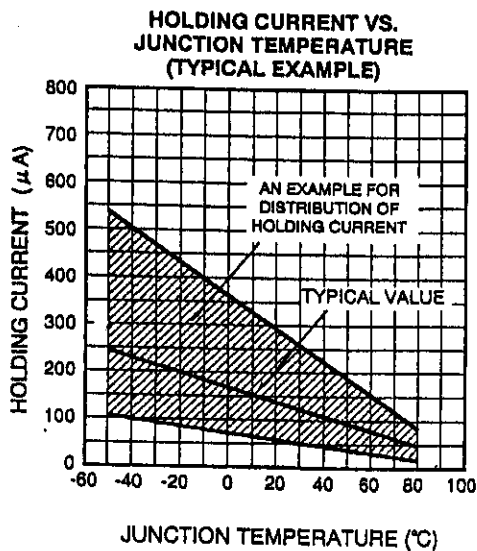
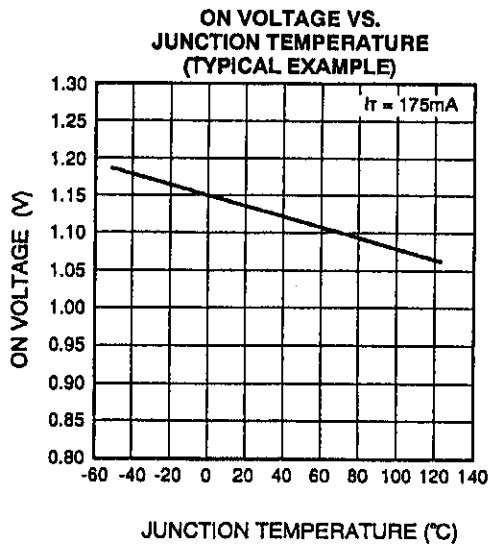
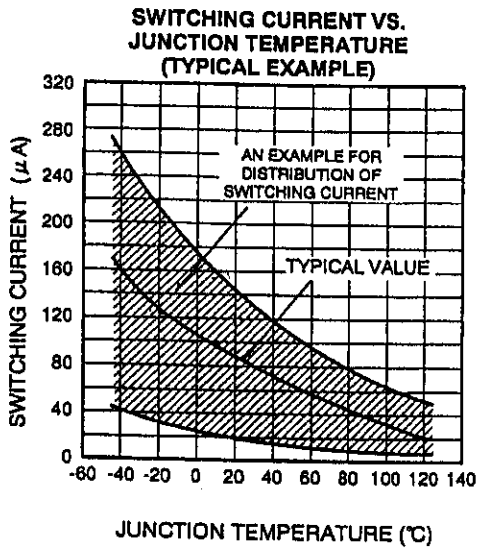
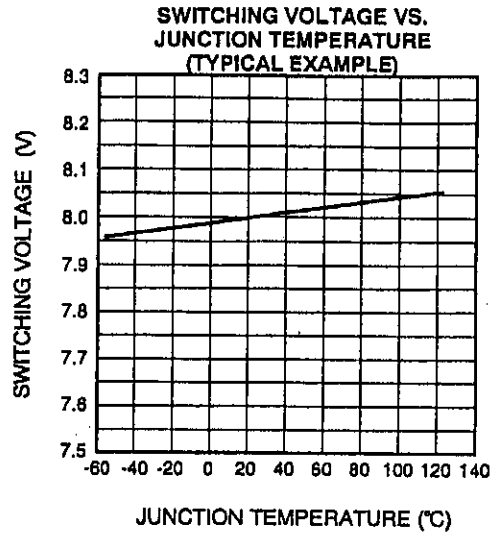
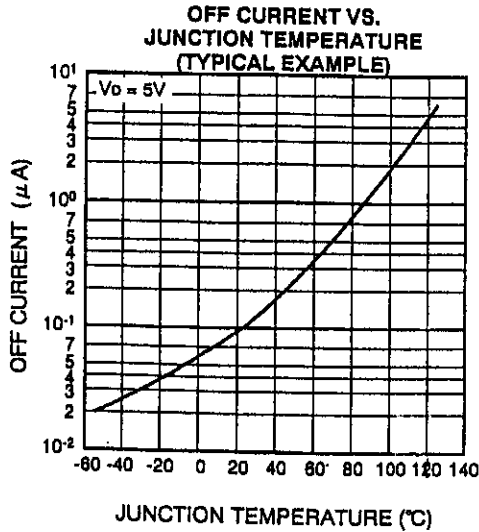

( TRIGGER ELEMENT )

# BS08D, BS08E

TRIGGER APPLICATION  
LEAD MOUNT TYPE, PLANE-MOUNTED TYPE (SC-59 OUTLINE)

GATE TRIGGER VOLTAGE VS.  
JUNCTION TEMPERATURE  
(TYPICAL EXAMPLE)

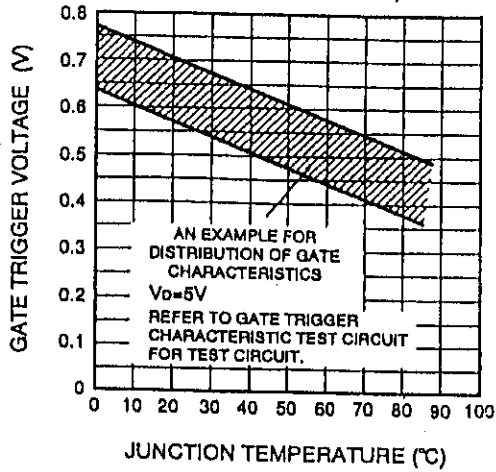

GATE TRIGGER CHARACTERISTIC TEST CIRCUIT

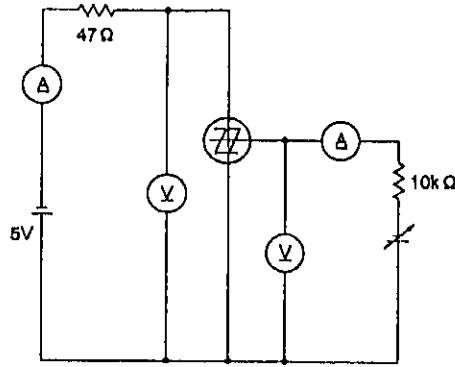

## APPLICATION EXAMPLE

THYRISTOR TRIGGER CIRCUIT

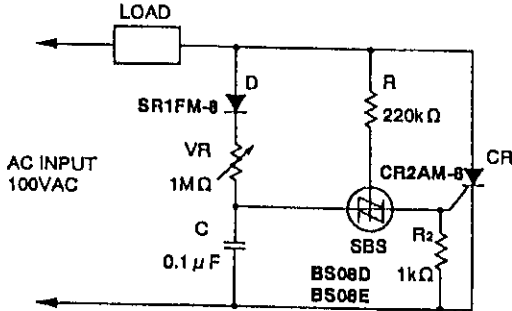

The above circuit is a thyristor phase control circuit making use of BS. In this circuit, using the SBS gate, the residual charge on C is reset, reducing the hysteresis characteristics. Therefore, over the range of the variable resistor, phase control (in the range 5 to 175°C) is possible, making this circuit widely useful in DC motor control and other control applications.

TRIAC TRIGGER CIRCUIT

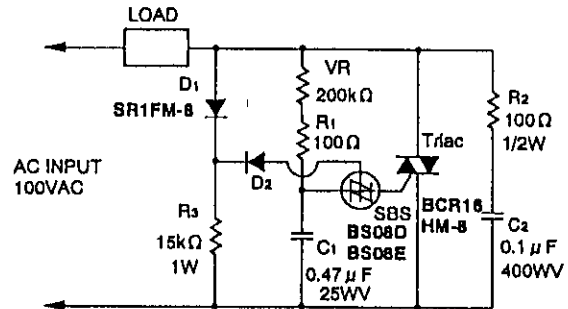

The above circuit is a triac phase control circuit making use of an SBS. In this circuit, an SBS gate is used to reduce the hysteresis characteristics. Thus, by using the variable resistance, phase control is possible over the wide range of 10 to 160°C. Therefore, this circuit is widely usable in such applications as lighting control circuits, electric heater control, and other load control applications.

# BS08D, BS08E

## TRIGGER APPLICATION LEAD MOUNT TYPE, PLANE-MOUNTED TYPE (SC-59 OUTLINE)

### Constant-speed control circuit of an universal motor FEATURES

- (1) The feedback amount is automatically controlled by the motor speed for easy constant-speed operation.
- (2) The feedback amount required for each motor type can be adjusted by resistor VR2, thus enabling control of various types of motors.

### OPERATING PRINCIPLE

The speed of motor is adjusted by VR1 in the phase-shifting circuit. In the comparison circuit, the reference voltage supplied by the Zener diode and the armature voltage are compared, and C in the phase-shifting circuit is charged by the difference of voltages. The effect of feedback is negligible as the sum of VR1 and C is small during high-speed operation, but, during low-speed operation, when the sum of VR1 and C is large, even a small feedback is effective and constant operation is improved at low-speed operation. (Patented by Mitsubishi Electric)

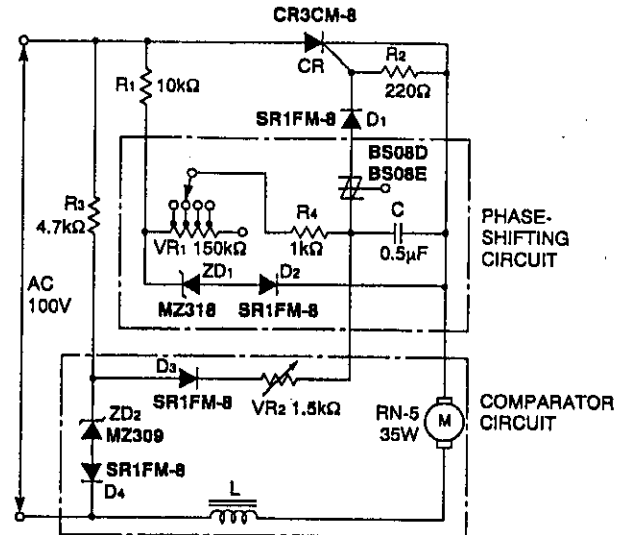

### Gas/Petroleum ignition circuit FEATURES

- (1) When the power supply is in the negative half cycle, spark discharge occurs. Compact and small-capacity resistor R1 and a thyristor can be used as the current does not flow from the power supply of the thyristor.
- (2) High-voltage pulses of more than 14kV are output to cause certain ignition of gas or kerosine.

### OPERATING PRINCIPLE

Capacitor C1 is charged through R1 and D1 during the half cycle of positive power supply and C2 is charged through R2 using the reverse voltage applied to D1. In this case, R1, R2, C1 and C2 should be selected to make  $R_1 C_1 \ll R_2 C_2$ . SBS is turned on as C2 reaches the switching voltage after C1 is fully charged, and the gate current flows to the thyristor CR. The electric charge charged in C1 is instantly discharged through CR, and after C1 is charged with the reverse polarity, it is discharged again through D2 and the coil, and then C1 is charged again with the original polarity. Thus high voltage is generated (more than 14kV) on the secondary side of the coil by the current flowing through the coil to produce spark discharge at the discharge gap.

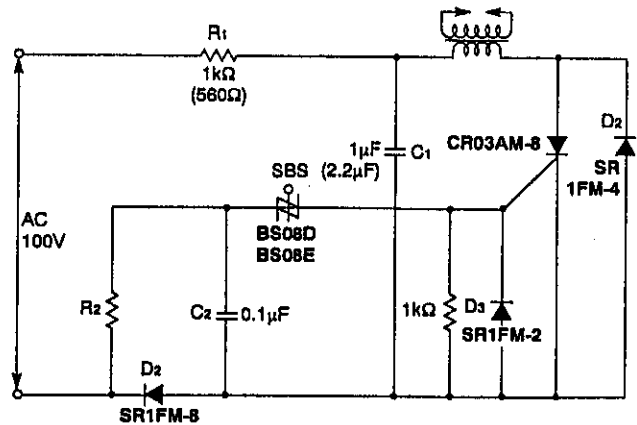

GAS IGNITION UNIT..... R1=1kΩ, C1=1μF  
PETROLEUM IGNITION UNIT..... R1=560Ω, C1=2.2μF

### Electric foot warmer (kotatsu)

#### FEATURES

Non-stage and wide-range control of the temperature of kotatsu is possible.

#### OPERATING PRINCIPLE

The temperature is controlled by trigger pulses generated by VR, PTh, R1, BM, R3 and C4 and by the control of the trigger phase of triac BCR. If the temperature exceeds a specified value after the temperature is set by VR, the resistive value of positive-type thermistor PTh increases and the conductive angle of BCR becomes smaller and so the temperature falls. If the value decreases, the conductive angle becomes larger and the temperature rises.

The bimetal switch BM detects sudden temperature rises and turns the BCR to an off state and stops the power supply. R2 is provided to prevent re-triggering of SBS.

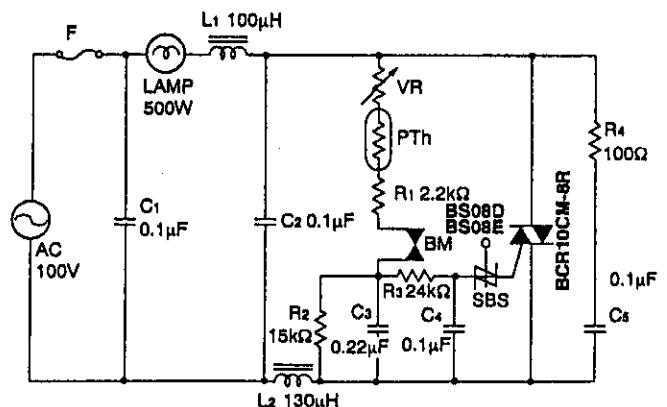

(TRIGGER ELEMENT)

# BS08D,BS08E

## TRIGGER APPLICATION LEAD MOUNT TYPE, PLANE-MOUNTED TYPE (SC-59 OUTLINE)

Example of a basic phase control circuit using BS08D,BS08E and BCR (or CR)

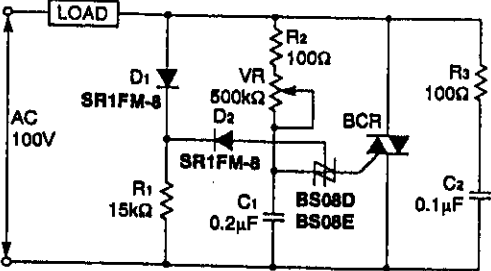
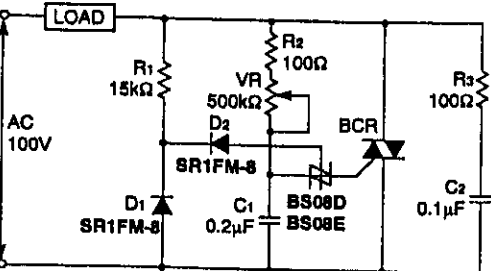
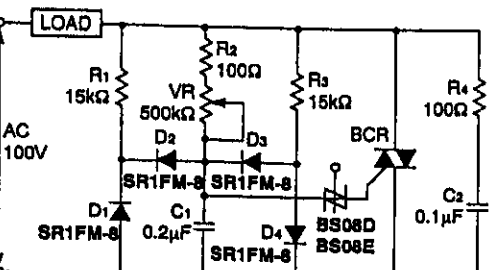
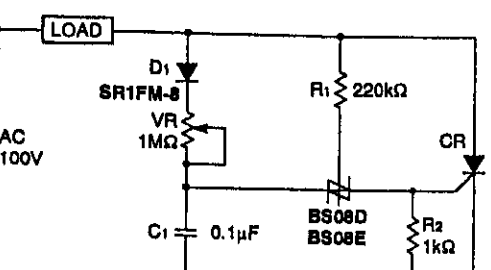
Circuit diagram	Features	Operating principle
 <p>AC 100V</p> <p>LOAD</p> <p>D1 SR1FM-8</p> <p>R1 15kΩ</p> <p>D2 SR1FM-8</p> <p>VR 500kΩ</p> <p>R2 100Ω</p> <p>R3 100Ω</p> <p>C1 0.2μF</p> <p>BS08D BS08E</p> <p>BCR</p>	<ul style="list-style-type: none"> <li>• Smooth control is possible in the range of 5 to 99% of the load power supply for AC input voltage.</li> <li>• Suitable for resistive load.</li> <li>• Phase control range is 10 to 150°</li> </ul>	<p>The triac BCR trigger phase is controlled by the CR phase-shifting circuit consisting of VR and C1, and hysteresis is reduced by D1,D2,R1 and the gate of BS08D,BS08E.</p>
 <p>AC 100V</p> <p>LOAD</p> <p>R1 15kΩ</p> <p>D1 SR1FM-8</p> <p>D2 SR1FM-8</p> <p>VR 500kΩ</p> <p>R2 100Ω</p> <p>R3 100Ω</p> <p>C1 0.2μF</p> <p>BS08D BS08E</p> <p>BCR</p>	<ul style="list-style-type: none"> <li>• Smooth control is possible in the range of 5 to 99% of the load power supply for AC input voltage.</li> <li>• Suitable for resistive load.</li> <li>• Phase control range is 10 to 150°</li> </ul>	<p>The triac BCR trigger phase is controlled by the CR phase-shifting circuit consisting of VR and C1, and hysteresis is reduced by D1,D2,R1 and the gate of BS08D,BS08E.</p>
 <p>AC 100V</p> <p>LOAD</p> <p>R1 15kΩ</p> <p>D1 SR1FM-8</p> <p>D2 SR1FM-8</p> <p>VR 500kΩ</p> <p>R2 100Ω</p> <p>R3 15kΩ</p> <p>R4 100Ω</p> <p>C1 0.2μF</p> <p>D3 SR1FM-8</p> <p>D4 SR1FM-8</p> <p>BS08D BS08E</p> <p>BCR</p>	<ul style="list-style-type: none"> <li>• Smooth control is possible in the range of 5 to 99% of the load power supply for AC input voltage.</li> <li>• Suitable for inductive load.</li> <li>• Phase control range is 10 to 150°</li> </ul>	<p>The triac BCR trigger phase is controlled by the CR phase-shifting circuit consisting of VR and C1, and hysteresis is reduced by D1,D2,D3,D4,R1,R3.</p>
 <p>AC 100V</p> <p>LOAD</p> <p>D1 SR1FM-8</p> <p>VR 1MΩ</p> <p>R1 220kΩ</p> <p>C1 0.1μF</p> <p>BS08D BS08E</p> <p>R2 1kΩ</p> <p>CR</p>	<ul style="list-style-type: none"> <li>• Smooth control is possible in the range of 1 to 99% of the load power supply for AC input voltage.</li> <li>• Suitable for both resistive and inductive loads.</li> <li>• Phase control range is 10 to 170°</li> </ul>	<p>The thyristor CR trigger phase is controlled by the CR phase-shifting circuit consisting of VR and C1. The voltage of C1 is reset and hysteresis is reduced by applying the gate current of BS08D,BS08E to C1, and by switching the BS08D,BS08E, applying the gate, R1, load, power supply and circuit C1.</p>

BCR : Triacs of 1A to 30A class can be used.

BCR : Triacs of 1A to 30A class can be used.

BCR : Triacs of 1A to 30A class can be used.

CR : Thyristors of 0.3A to 20A class can be used.

( TRIGGER ELEMENT)

## BS08D,BS08E

TRIGGER APPLICATION  
LEAD MOUNT TYPE, PLANE-MOUNTED TYPE (SC-59 OUTLINE)

### Electric starter for fluorescent lamps

#### FEATURES

Employment of a non-linear saturable capacitor, triac and reverse-blocking two-terminal thyristor provides a cheap, compact and light-weight electric starter for fluorescent lamp with short turn-on time.

#### OPERATING PRINCIPLE

If the power supply switch is turned on, the bilateral switching device Q<sub>1</sub> is set on at a proper phase θ<sub>1</sub> of the positive half cycle of the power supply at the early stage of startup, and triac Q<sub>2</sub> is triggered. If Q<sub>2</sub> is turned on, non-linear saturable capacitor C<sub>1</sub> with charge saturation characteristic under a specified charge voltage is charged quickly by the power supply through the stabilizer with polarity as illustrated.

C<sub>1</sub> enters quickly into the saturation area and the current flowing to the stabilizer decreases instantly, and the high-voltage pulses of  $e = L (di/dt)$  are generated in the stabilizer. The reverse-blocking two-terminal thyristor Q<sub>3</sub> is triggered by this pulse, and a pre-

heating current flows to the filament of the fluorescent lamp. The conducting current of Q<sub>3</sub> becomes zero at the phase θ<sub>2</sub> of the negative half cycle of power supply, and Q<sub>3</sub> is turned off. Then, the near-the-peak voltage of the negative half cycle of the supply voltage is suddenly applied at both ends of the fluorescent lamp, Q<sub>1</sub> and Q<sub>2</sub> are turned on again and C<sub>1</sub> is charged quickly, with the reverse polarity as illustrated. With the same mechanism, high-voltage pulses (about 1.5kV) with the reverse polarity are generated in the stabilizer and the turn-on pulse is applied at both ends of the fluorescent lamp.

Then the same operation continues and the light is turned on if the filament is sufficiently heated. (Approximately 0.5 seconds after the power is supplied.) If the lamp is turned on, the voltage applied at both ends of the lamp decrease, and Q<sub>1</sub>, Q<sub>2</sub> and Q<sub>3</sub> are set off. Then preheating and high voltage pulses are stopped.

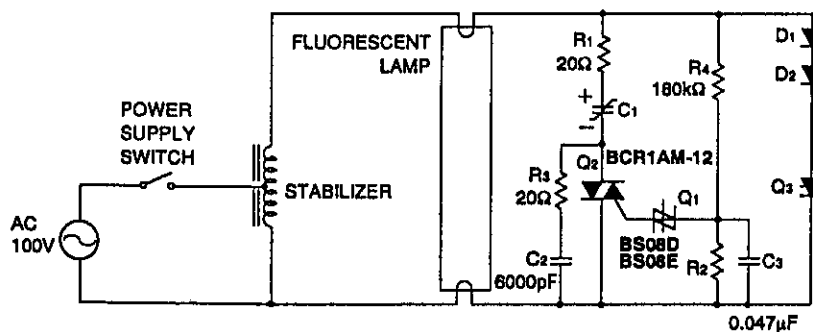

(CIRCUIT CONSTANTS ARE USED FOR 32W TYPE)

---

 **ISAHAYA ELECTRONICS CORPORATION**

<http://www.idc-com.co.jp>

6-41, TSUKUBA, ISAHAYA, NAGASAKI, 854-0065, JAPAN

Keep safety in your circuit designs !

Isahaya Electronics Corporation puts the maximum effort into making semiconductor products better and more reliable, but there is always the possibility that trouble may occur with them. Trouble with semiconductors may lead to personal injury, fire or property damage. Remember to give consideration to safety when making your circuit designs, with appropriate measures such as (i) placement of substitutive, auxiliary circuits, (ii) use of non-flammable material or (iii) prevention against any malfunction or mishap.

Notes regarding these materials

•These materials are intended as reference to assist out customers in the selection of the Isahaya semiconductor product best suited to the customer's application, they do not convey any license under any intellectual property rights, or any other rights, belonging to Isahaya Electronics Corporation or a third party.  
•Isahaya Electronics Corporation assumes no responsibility for any damage, or infringement of any third-party rights, originating in the use of any product data, diagrams, charts or circuit application examples contained in the materials.  
•All information contained in these materials, including product data, diagrams and charts, represent information on products at the time of publication of these materials, and are subject to change by Isahaya Electronics Corporation without notice due to product improvements or other reasons. It is therefore recommended that customers contact Isahaya Electronics Corporation or authorized Isahaya Semiconductor product distributor for the latest product information before purchasing a product listed herein.  
•The prior written approval of Isahaya Electronics Corporation is necessary to reprint or reproduce in whole or in part these materials.  
•If these products or technologies are subject to the Japanese export control restrictions, they must be exported under a license from the Japanese government and cannot be imported into a country other than the approved destination. Any diversion or reexport contrary to the export control laws and regulations of Japan and/or the country of destination is prohibited.  
•Please contact Isahaya Electronics Corporation or an authorized Isahaya Semiconductor product distributor for further details on these materials or the products contained therein.