



TP0610KL/BS250KL
Vishay Siliconix

New Product

P-Channel 60-V (D-S) MOSFET

PRODUCT SUMMARY			
$V_{(BR)DSS(min)}$ (V)	$r_{DS(on)}$ (Ω)	$V_{GS(th)}$ (V)	I_D (A)
-60	6 @ $V_{GS} = -10$ V	-1 to -3.0	-0.27
	10 @ $V_{GS} = -4.5$ V		-0.21

FEATURES

- TrenchFET® Power MOSFET
- ESD Protected: 2000 V

APPLICATIONS

- Drivers: Relays, Solenoids, Lamps, Hammers, Displays, Memories, Transistors, etc.
- Battery Operated Systems
- Power Supply, Converter Circuits
- Motor Control

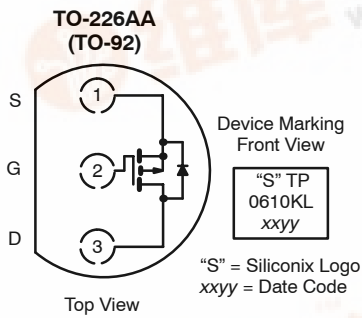

Ordering Information: TP0610KL-TR1

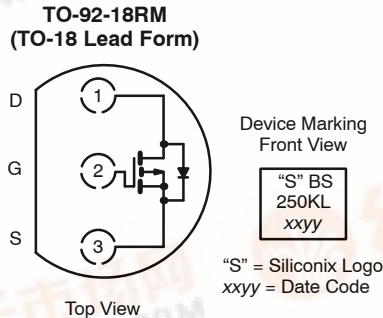

Ordering Information: BS250KL-TR1

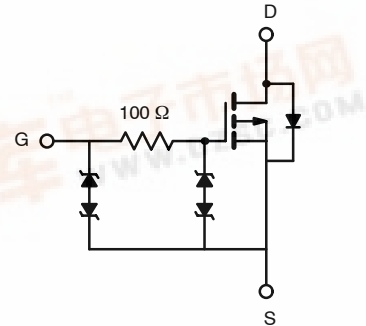

ABSOLUTE MAXIMUM RATINGS ($T_A = 25^\circ\text{C}$ UNLESS OTHERWISE NOTED)

Parameter	Symbol	Limit	Unit	
Drain-Source Voltage	V_{DS}	-60	V	
Gate-Source Voltage	V_{GS}	± 20		
Continuous Drain Current	I_D	$T_A = 25^\circ\text{C}$	-0.27	A
		$T_A = 70^\circ\text{C}$	-0.22	
Pulse Drain Current ^a	I_{DM}	-1.0		
Power Dissipation	P_D	$T_A = 25^\circ\text{C}$	0.8	W
		$T_A = 70^\circ\text{C}$	0.51	
Maximum Junction-to-Ambient	R_{thJA}	156	$^\circ\text{C}/\text{W}$	
Operating Junction and Storage Temperature Range	T_J, T_{stg}	-55 to 150	$^\circ\text{C}$	

Notes:
a. Pulse width limited by maximum junction temperature.

TP0610KL/BS250KL

Vishay Siliconix

New Product



SPECIFICATIONS (T _A = 25 °C UNLESS OTHERWISE NOTED)							
Parameter	Symbol	Test Condition	Min	Typ	Max	Unit	
Static							
Drain-Source Breakdown Voltage	V _{(BR)DSS}	V _{GS} = 0 V, I _D = -10 μA	-60			V	
Gate-Threshold Voltage	V _{GS(th)}	V _{DS} = V _{GS} , I _D = -250 μA	-1	-2.1	-3.0		
Gate-Body Leakage	I _{GSS}	V _{DS} = 0 V, V _{GS} = ±20 V			±10	μA	
		V _{DS} = 0 V, V _{GS} = ±10 V			±200		
		V _{DS} = 0 V, V _{GS} = ±10 V, T _J = 85 °C			±500	nA	
		V _{DS} = 0 V, V _{GS} = ±5 V			±100		
Zero Gate Voltage Drain Current	I _{DSS}	V _{DS} = -60 V, V _{GS} = 0 V			-1	μA	
		V _{DS} = -60 V, V _{GS} = 0 V, T _J = 55 °C			-10		
On-State Drain Current ^a	I _{D(on)}	V _{DS} = -10 V, V _{GS} = -4.5 V	-50			mA	
		V _{DS} = -10 V, V _{GS} = -10 V	-600				
Drain-Source On-Resistance ^a	r _{DS(on)}	V _{GS} = -4.5 V, I _D = -25 mA		5.5	10	Ω	
		V _{GS} = -10 V, I _D = -500 mA		3.1	6		
		V _{GS} = -10 V, I _D = -500 mA, T _J = 125 °C		4.7	9		
Forward Transconductance ^a	g _{fs}	V _{DS} = -10 V, I _D = -100 mA		180		mS	
Diode Forward Voltage ^a	V _{SD}	I _S = -200 mA, V _{GS} = 0 V		-0.9	-1.4	V	
Dynamic^b							
Total Gate Charge	Q _g	V _{DS} = -30 V, V _{GS} = -15 V, I _D ≈ -500 mA		1.7	3	nC	
Gate-Source Charge	Q _{gs}			0.26			
Gate-Drain Charge	Q _{gd}			0.46			
Gate Resistance	R _g			285		Ω	
Turn-On Time	t _{d(on)}	V _{DD} = -25 V, R _L = 150 Ω I _D ≈ -150 mA, V _{GEN} = -10 V R _g = 10 Ω		2.4	5	ns	
	t _r			15.5	25		
Turn-Off Time	t _{d(off)}			21	35		
	t _f			12.5	20		

Notes

- a. Pulse test: PW ≤ 300 ms duty cycle ≤ 2%.
- b. Guaranteed by design, not subject to production testing.

TYPICAL CHARACTERISTICS (25 °C UNLESS NOTED)

For the following graphs, p-channel negative polarities for all voltage and current values are represented as positive values.

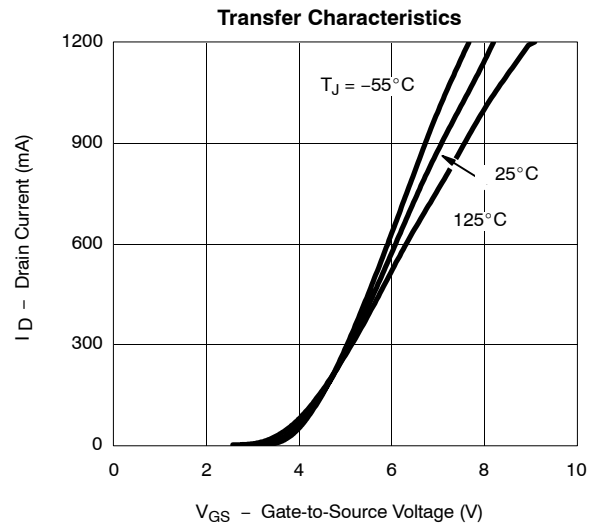
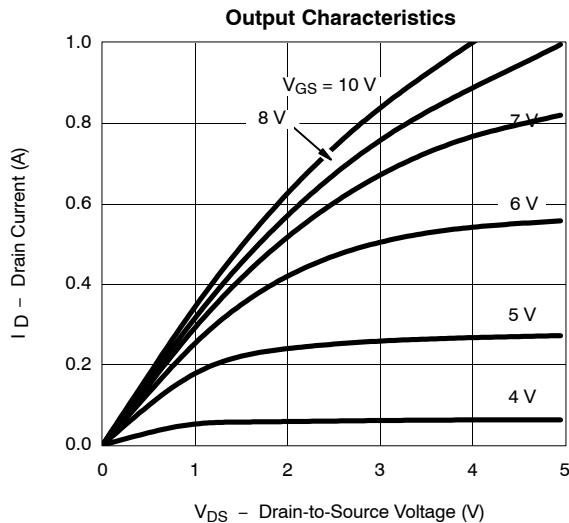



TYPICAL CHARACTERISTICS (25°C UNLESS NOTED)

For the following graphs, p-channel negative polarities for all voltage and current values are represented as positive values.

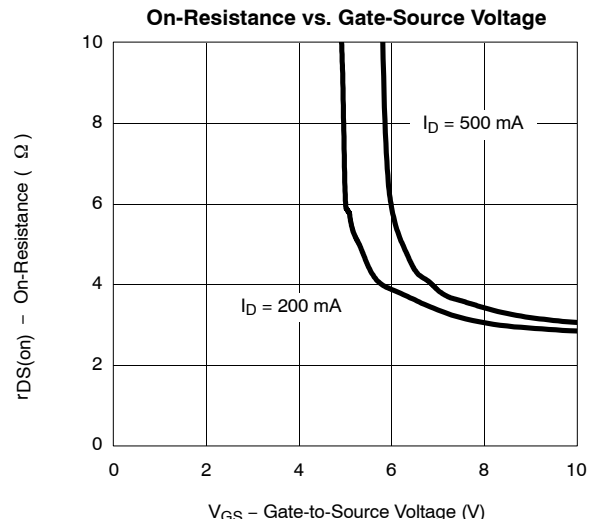
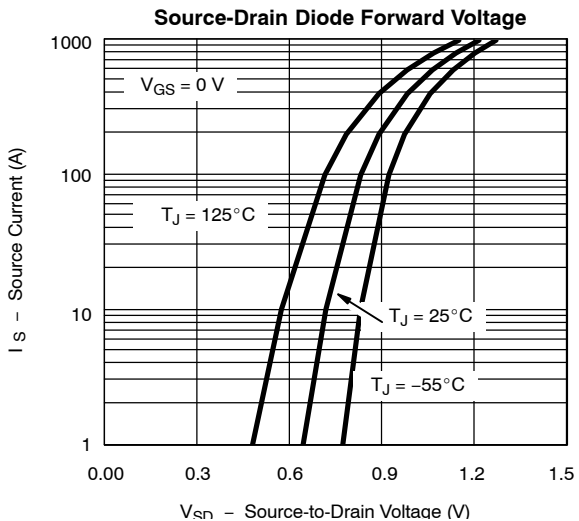
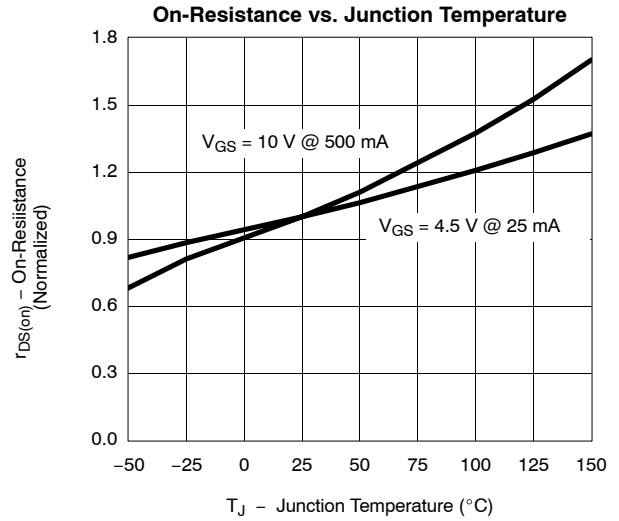
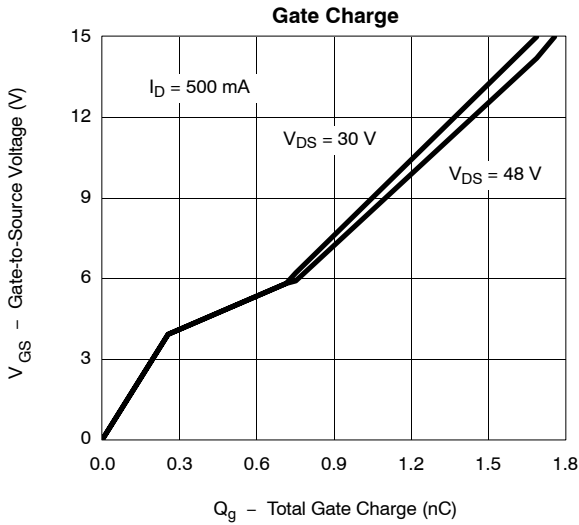
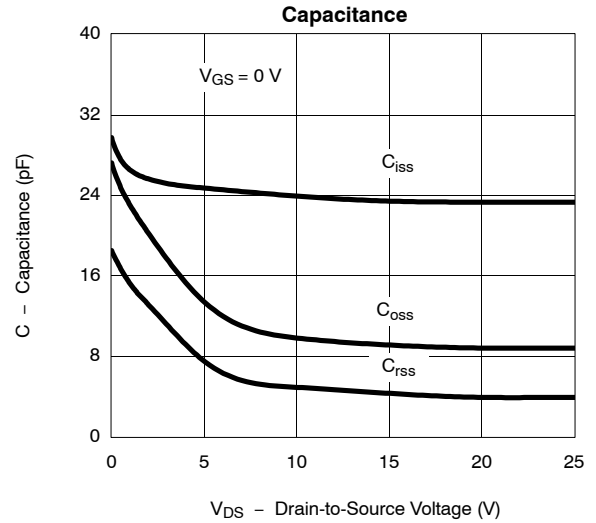
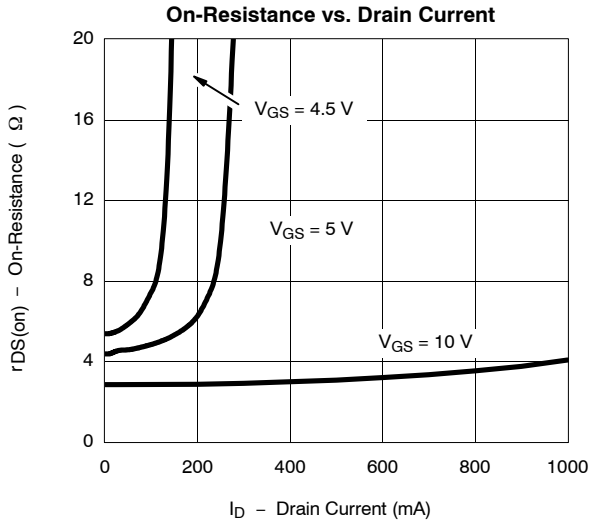

TYPICAL CHARACTERISTICS (25°C UNLESS NOTED)

For the following graphs, p-channel negative polarities for all voltage and current values are represented as positive values.

