

SIPMOS[®] Small-Signal Transistor

- N channel
- Enhancement mode
- Logic Level
- $V_{GS(th)} = 0.8...2.0V$

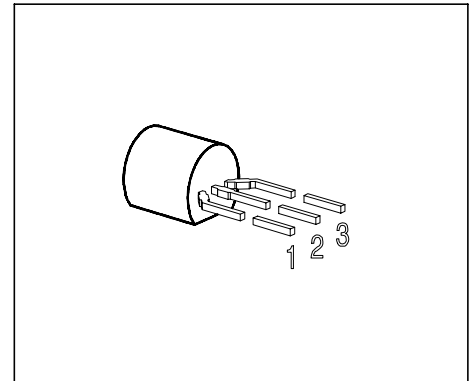

| | | |
|-------|-------|-------|
| Pin 1 | Pin 2 | Pin 3 |
| G | D | S |

| Type | V_{DS} | I_D | $R_{DS(on)}$ | Package | Marking |
|---------|----------|-------|--------------|---------|---------|
| BSS 296 | 100 V | 0.8 A | 0.8 Ω | TO-92 | SS 296 |

| Type | Ordering Code | Tape and Reel Information |
|---------|---------------|---------------------------|
| BSS 296 | Q62702-S217 | E6296 |

Maximum Ratings

| Parameter | Symbol | Values | Unit |
|---|-------------|----------|------|
| Drain source voltage | V_{DS} | 100 | V |
| Drain-gate voltage $R_{GS} = 20 \text{ k}\Omega$ | V_{DGR} | 100 | |
| Gate source voltage | V_{GS} | ± 14 | |
| Gate-source peak voltage, aperiodic | V_{gs} | ± 20 | |
| Continuous drain current $T_A = 25 \text{ }^\circ\text{C}$ | I_D | 0.8 | A |
| DC drain current, pulsed $T_A = 25 \text{ }^\circ\text{C}$ | I_{Dpuls} | 3.2 | |
| Power dissipation $T_A = 25 \text{ }^\circ\text{C}$ | P_{tot} | 1 | W |

Maximum Ratings

| Parameter | Symbol | Values | Unit |
|---|------------|---------------|------|
| Chip or operating temperature | T_j | -55 ... + 150 | °C |
| Storage temperature | T_{stg} | -55 ... + 150 | |
| Thermal resistance, chip to ambient air ¹⁾ | R_{thJA} | ≤ 125 | K/W |
| DIN humidity category, DIN 40 040 | | E | |
| IEC climatic category, DIN IEC 68-1 | | 55 / 150 / 56 | |

Electrical Characteristics, at $T_j = 25^\circ\text{C}$, unless otherwise specified

| Parameter | Symbol | Values | | | Unit |
|-----------|--------|--------|------|------|------|
| | | min. | typ. | max. | |

Static Characteristics

| | | | | | |
|--|---------------|-----|---------------|----------------|-------------------------|
| Drain- source breakdown voltage $V_{GS} = 0 \text{ V}, I_D = 0.25 \text{ mA}, T_j = 25 \text{ }^\circ\text{C}$ | $V_{(BR)DSS}$ | 100 | - | - | V |
| Gate threshold voltage $V_{GS}=V_{DS}, I_D = 1 \text{ mA}$ | $V_{GS(th)}$ | 0.8 | 1.4 | 2 | |
| Zero gate voltage drain current $V_{DS} = 100 \text{ V}, V_{GS} = 0 \text{ V}, T_j = 25 \text{ }^\circ\text{C}$ $V_{DS} = 100 \text{ V}, V_{GS} = 0 \text{ V}, T_j = 125 \text{ }^\circ\text{C}$ $V_{DS} = 60 \text{ V}, V_{GS} = 0 \text{ V}, T_j = 25 \text{ }^\circ\text{C}$ | I_{DSS} | - | 0.1 8 - | 1 50 100 | μA nA |
| Gate-source leakage current $V_{GS} = 20 \text{ V}, V_{DS} = 0 \text{ V}$ | I_{GSS} | - | 10 | 100 | nA |
| Drain-Source on-state resistance $V_{GS} = 10 \text{ V}, I_D = 0.8 \text{ A}$ $V_{GS} = 4.5 \text{ V}, I_D = 0.8 \text{ A}$ | $R_{DS(on)}$ | - | 0.5 0.6 | 0.8 1.4 | Ω |

Electrical Characteristics, at $T_j = 25^\circ\text{C}$, unless otherwise specified

| Parameter | Symbol | Values | | | Unit |
|-----------|--------|--------|------|------|------|
| | | min. | typ. | max. | |

Dynamic Characteristics

| | | | | | |
|--|--------------|-----|-----|-----|----|
| Transconductance $V_{DS} \geq 2 * I_D * R_{DS(on)max}, I_D = 0.8 \text{ A}$ | g_{fs} | 0.5 | 1.2 | - | S |
| Input capacitance $V_{GS} = 0 \text{ V}, V_{DS} = 25 \text{ V}, f = 1 \text{ MHz}$ | C_{iss} | - | 300 | 400 | pF |
| Output capacitance $V_{GS} = 0 \text{ V}, V_{DS} = 25 \text{ V}, f = 1 \text{ MHz}$ | C_{oss} | - | 60 | 90 | |
| Reverse transfer capacitance $V_{GS} = 0 \text{ V}, V_{DS} = 25 \text{ V}, f = 1 \text{ MHz}$ | C_{rss} | - | 30 | 45 | |
| Turn-on delay time $V_{DD} = 30 \text{ V}, V_{GS} = 10 \text{ V}, I_D = 0.29 \text{ A}$ $R_G = 50 \Omega$ | $t_{d(on)}$ | - | 8 | 12 | ns |
| Rise time $V_{DD} = 30 \text{ V}, V_{GS} = 10 \text{ V}, I_D = 0.29 \text{ A}$ $R_G = 50 \Omega$ | t_r | - | 15 | 25 | |
| Turn-off delay time $V_{DD} = 30 \text{ V}, V_{GS} = 10 \text{ V}, I_D = 0.29 \text{ A}$ $R_G = 50 \Omega$ | $t_{d(off)}$ | - | 120 | 160 | |
| Fall time $V_{DD} = 30 \text{ V}, V_{GS} = 10 \text{ V}, I_D = 0.29 \text{ A}$ $R_G = 50 \Omega$ | t_f | - | 65 | 85 | |

Electrical Characteristics, at $T_j = 25^\circ\text{C}$, unless otherwise specified

| Parameter | Symbol | Values | | | Unit |
|-----------|--------|--------|------|------|------|
| | | min. | typ. | max. | |

Reverse Diode

| | | | | | |
|--|----------|---|-----|-----|---|
| Inverse diode continuous forward current $T_A = 25^\circ\text{C}$ | I_S | - | - | 0.8 | A |
| Inverse diode direct current, pulsed $T_A = 25^\circ\text{C}$ | I_{SM} | - | - | 3.2 | |
| Inverse diode forward voltage $V_{GS} = 0\text{ V}, I_F = 1.6\text{ A}$ | V_{SD} | - | 0.9 | 1.3 | V |

Power dissipation

$$P_{\text{tot}} = f(T_A)$$

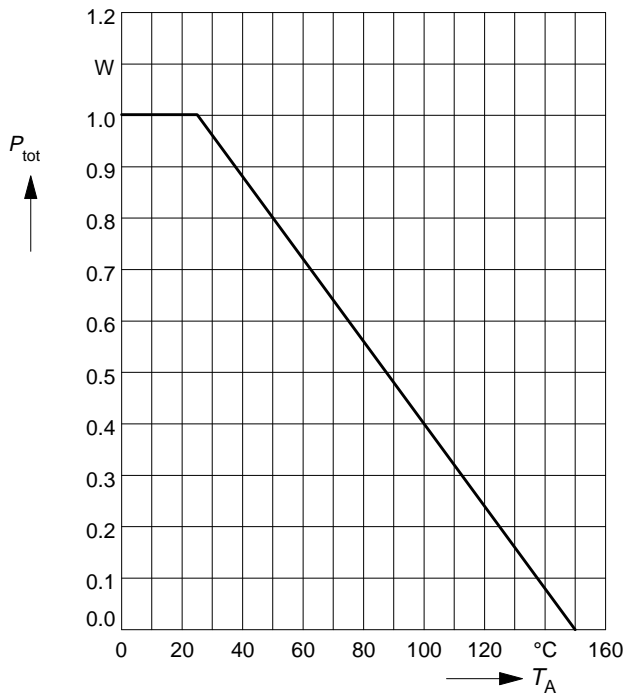

Drain current

$$I_D = f(T_A)$$

parameter: $V_{GS} \geq 10 \text{ V}$

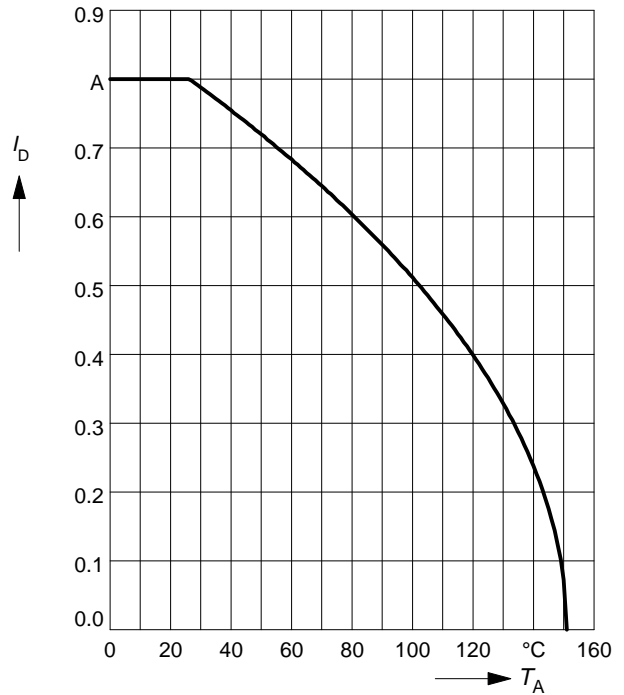

Safe operating area $I_D = f(V_{DS})$

parameter: $D = 0.01$, $T_C = 25^\circ\text{C}$

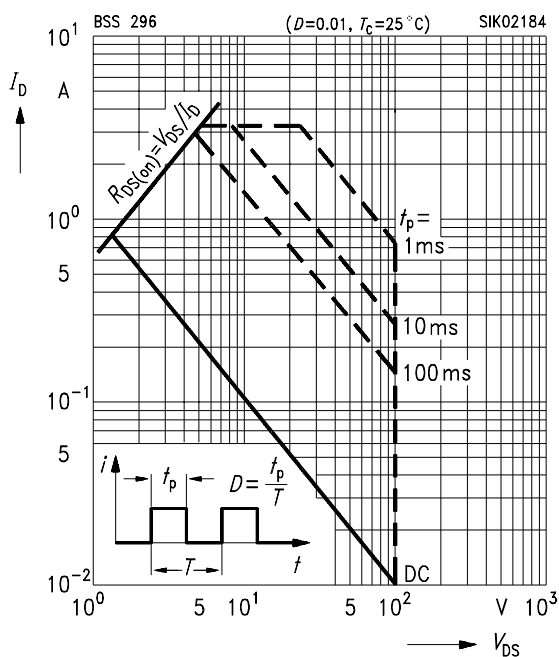

Drain-source breakdown voltage

$$V_{(BR)DSS} = f(T_j)$$

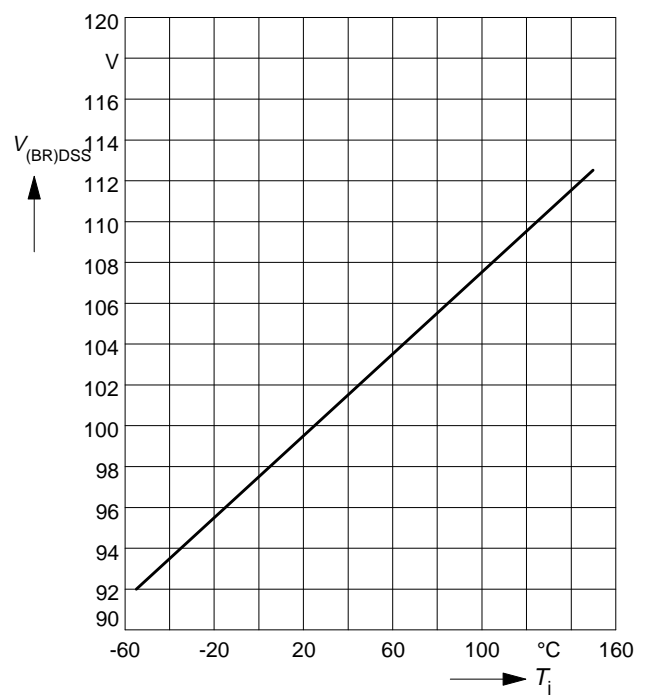

Typ. output characteristics

$$I_D = f(V_{DS})$$

parameter: $t_p = 80 \mu s$, $T_j = 25 \text{ }^\circ\text{C}$

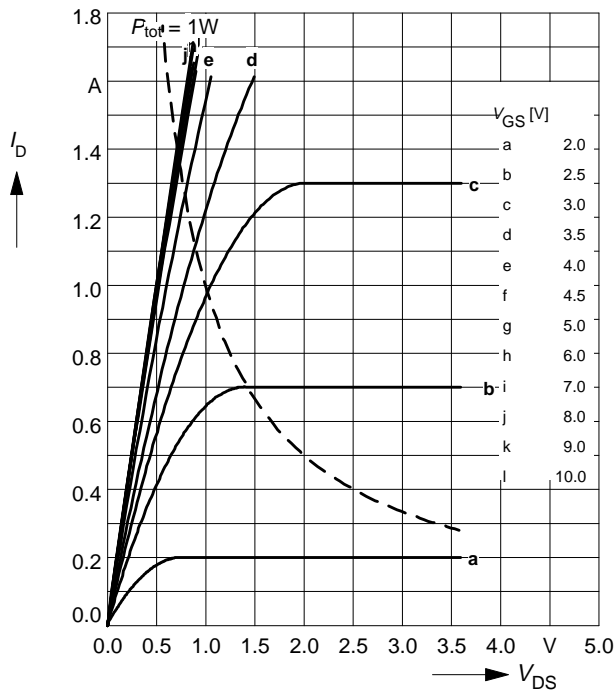

Typ. drain-source on-resistance

$$R_{DS(on)} = f(I_D)$$

parameter: $t_p = 80 \mu s$, $T_j = 25 \text{ }^\circ\text{C}$

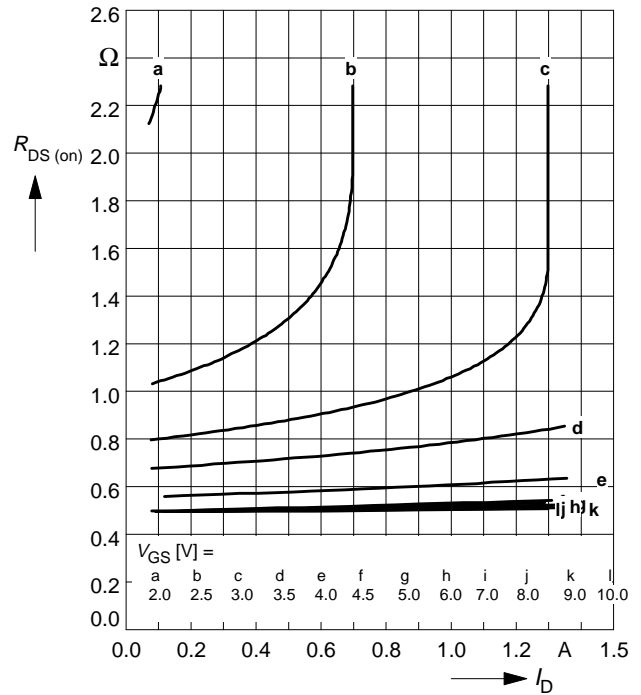

Typ. transfer characteristics $I_D = f(V_{GS})$

parameter: $t_p = 80 \mu s$

$V_{DS} \geq 2 \times I_D \times R_{DS(on)max}$

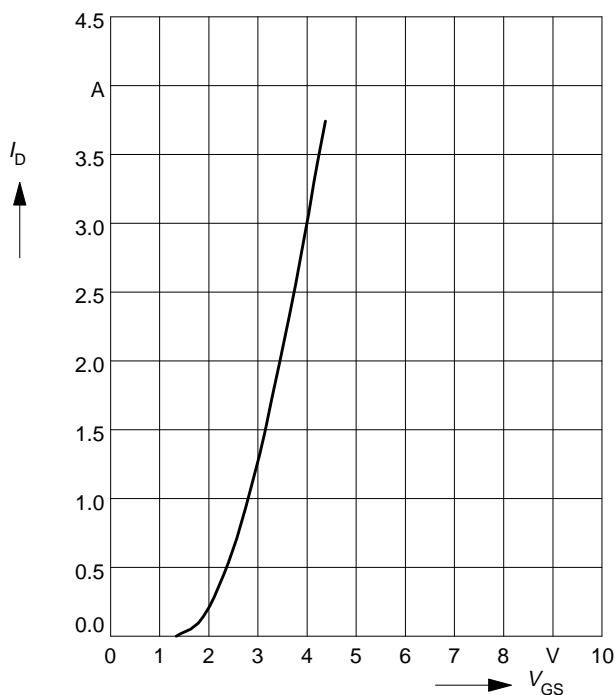

Typ. forward transconductance $g_{fs} = f(I_D)$

parameter: $t_p = 80 \mu s$,

$V_{DS} \geq 2 \times I_D \times R_{DS(on)max}$

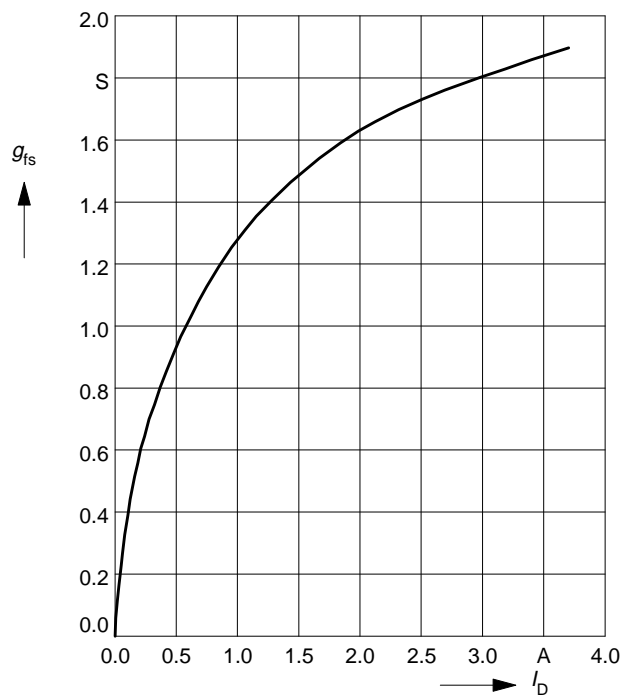

Drain-source on-resistance

$$R_{DS(on)} = f(T_j)$$

parameter: $I_D = 0.8 \text{ A}$, $V_{GS} = 10 \text{ V}$

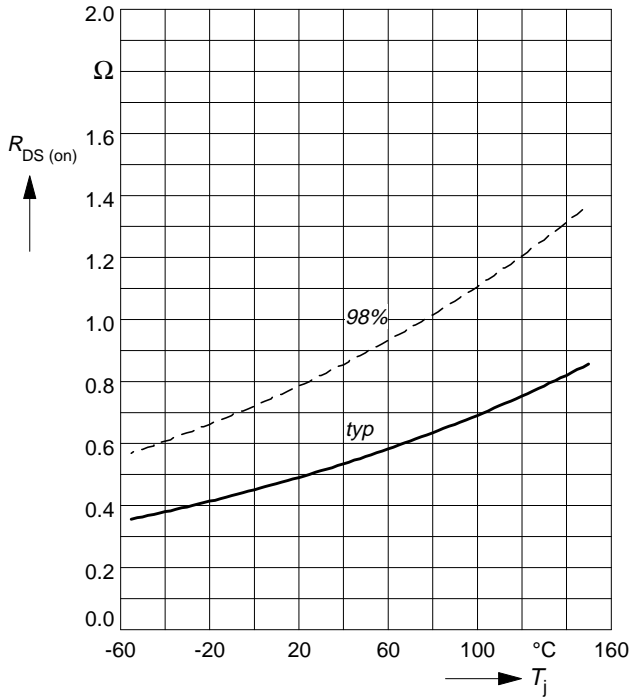

Gate threshold voltage

$$V_{GS(th)} = f(T_j)$$

parameter: $V_{GS} = V_{DS}$, $I_D = 1 \text{ mA}$

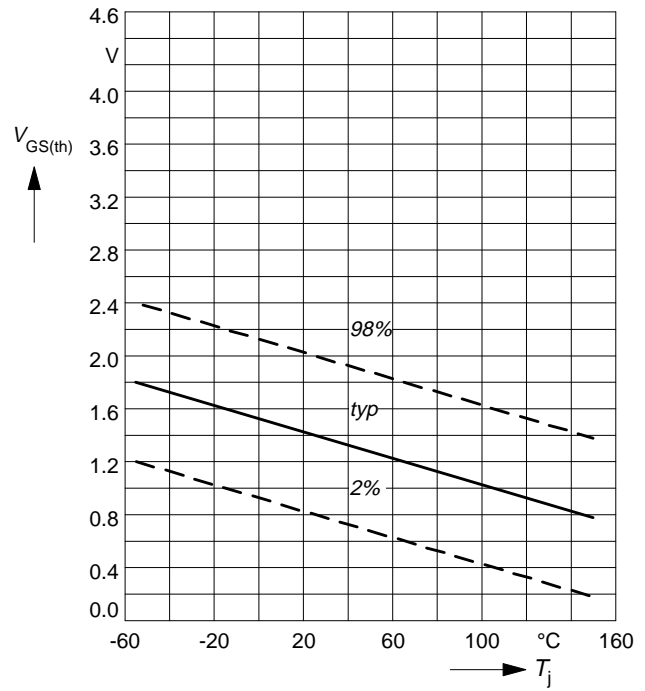

Typ. capacitances

$$C = f(V_{DS})$$

parameter: $V_{GS}=0\text{V}$, $f = 1 \text{ MHz}$

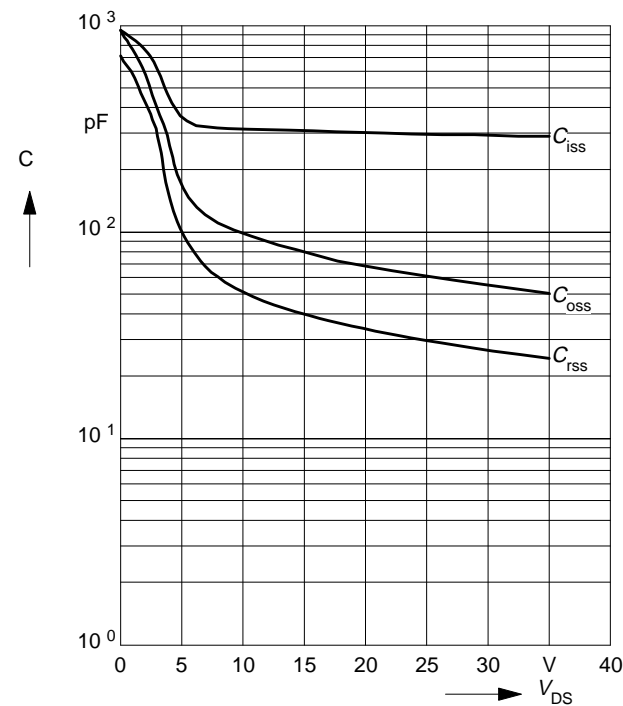

Forward characteristics of reverse diode

$$I_F = f(V_{SD})$$

parameter: $T_j, t_p = 80 \mu\text{s}$

