

FL tube driver

BU2872AK

The BU2872AK is a driver IC for the FL display unit. It has a total of 22 high withstanding voltage output pins, and supports displays ranging from 11-segment 11-character displays to 16-segment 4-character displays. A key scan function, LED drive output, and a general-purpose input pin make this IC ideal for use in the front panels of VTRs and other equipment. A serial interface enables control of all functions through a microcomputer.

●Applications

VCRs

●Features

- 1) High withstanding voltage output.
- 2) Display modes: 11S × 11G ~16S × 4G
- 3) Variable display luminance (7 steps).
- 4) 3-wire serial interface.
- 5) Key scanning function (6 × 4).
- 6) Internal pull-down resistance (high withstanding voltage output).
- 7) QFP 44-pin package.

●Block diagram

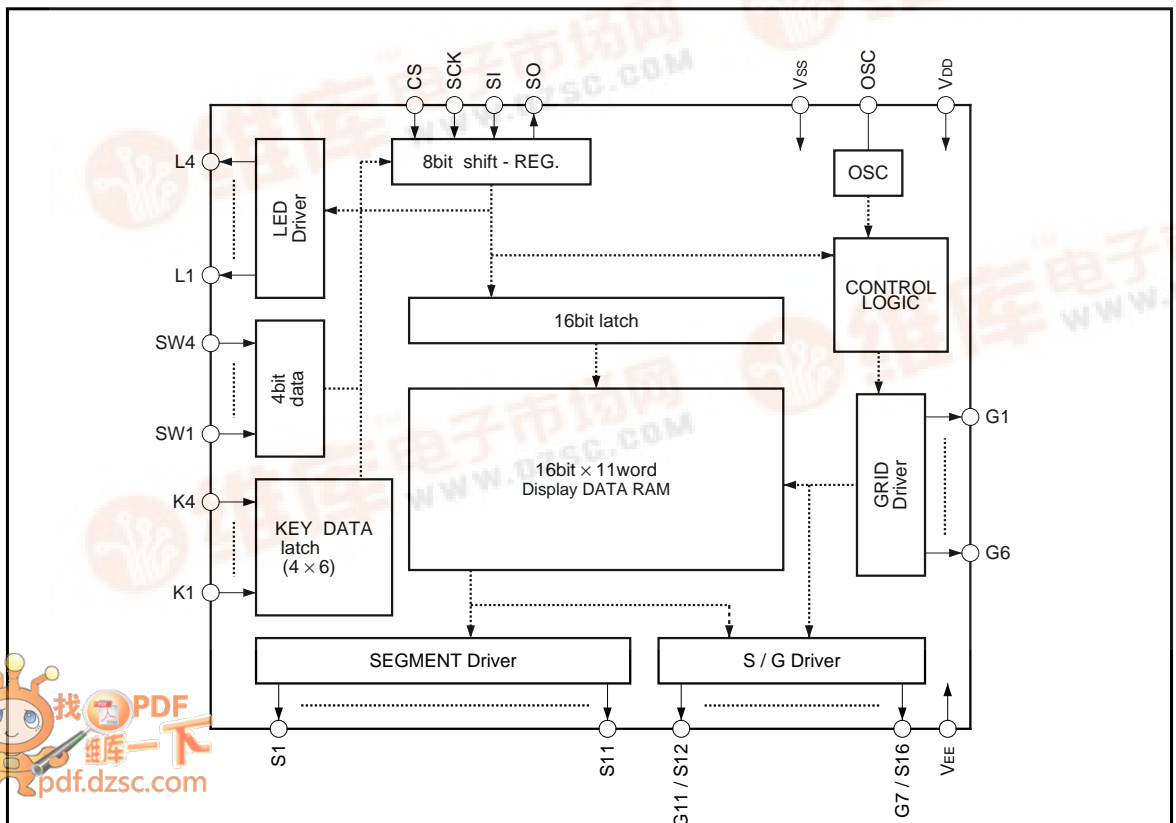

●Pin descriptions

Pin No.	Pin	Name	I / O	Function
14, 38	V _{DD}	Power supply pin 1	I	Connected to the power supply of the system
44	OSC	Oscillation pin	I / O	Connected to the oscillation capacitor
7, 43	V _{SS}	GND pin	I	Connected to the ground of the system
6	SI	Serial data input	I	Serial data input starting from MSB
5	SO	Serial data output	O	Serial data output starting from MSB
8	SCK	Serial clock input	I	Serial data read at rising edge
9	CS	Serial chip select	I	Serial initialization at "L", effective at "H"
15 ~ 25	S1 ~ S11	High withstanding voltage output pin for segment	O	Output pin for segment Output: Pch open drain + pull-down resistance
27	V _{EE}	Power supply pin 2	I	Pull-down resistance connection for FLP driver
37 ~ 32	G1 ~ G6	High withstanding voltage output pin for grid	O	Output pin for grid Output: Pch open drain + pull-down resistance
26, 28 ~ 31	S12 / G11 ~ S16 / G7	High withstanding voltage output pin for segment / grid	O	Segment / grid output selectable pin Output: Pch open drain + pull-down resistance
42 ~ 39	L1 ~ L4	Output pin for LED	O	Output pin for LED; output is CMOS output
10 ~ 13	K1 ~ K4	Key data input pin	I	Data input pin for key scanning
1 ~ 4	SW1 ~ SW4	General-purpose input pin	I	General-purpose input pin Input data sent to microcomputer in serial format

●Absolute maximum ratings (Ta = 25°C, V_{SS} = 0V)

Parameter	Symbol	Limits	Unit
Applied voltage 1	V _{DD}	- 0.3 ~ + 7.0	V
Applied voltage 2	V _{EE}	V _{DD} + 0.3 ~ V _{DD} - 35	V
Input voltage	V _{IN}	- 0.3 ~ V _{DD} + 0.3	V
Power dissipation	P _d	850*	mW
Operating temperature	T _{opr}	- 25 ~ + 75	°C
Storage temperature	T _{stg}	- 55 ~ + 125	°C

Note) Operation is not guaranteed at these values.

Power dissipation is reduced by 8.5mW for each increase in Ta of 1°C over 25°C.

* When mounted on a 70mm × 70mm × 1.6mm glass epoxy board

●Recommended operating conditions (Ta = 25°C, V_{SS} = 0V)

Parameter	Symbol	Min.	Typ.	Max.	Unit
Operating power supply voltage 1	V _{DD}	4.5	5.0	5.5	V
Operating power supply voltage 2	V _{EE}	V _{DD} - 32	V _{DD} - 30	V _{DD} - 0	V

●Electrical characteristics (unless otherwise noted, Ta = 25°C, VDD = 5V, VSS = 0V, VDD-VEE = 30V)

Parameter	Symbol	Min.	Typ.	Max.	Unit	Conditions	Measurement circuit
Supply current	I _{DD}	—	—	5	mA	Pin 44 external 1000 pF, when oscillated	Fig.1
Input threshold voltage	V _{IN}	1.5	—	3.5	V	Pins 1 to 4, 6, 8, 9 to 13	Fig.5
Input current	I _{IN}	—	—	10	μA	Pins 1 to 4, 6, 8, 9 to 13	Fig.2
Oscillation frequency	F _{OSC}	130	200	300	kHz	Pin 44 external 1000 pF	Fig.4
Segment output current	I _{Oseg}	7	—	—	mA	Pins 15 to 26, 28 to 31 V _O = V _{DD} - 2V *2	Fig.2
Grid output current	I _{Ogrd}	20	—	—	mA	Pins 26, 28 to 37 V _O = V _{DD} - 2V *2	Fig.2
Off level leakage current	I _{OFF}	—	—	10	μA	Pins 15 to 26, 28 to 37 V _O = V _{DD} - V _{EE}	Fig.2
Output pull-down resistance	R _D	15	31	60	kΩ	Pins 15 to 26, 28 to 37	Fig.2
LED output high level voltage	V _{OH}	4.0	—	—	V	Pins 39 to 42 I _O = 1mA	Fig.3
LED output low level voltage	V _{OL}	—	—	1.0	V	Pins 39 to 42 I _O = -10mA	Fig.3
〈Serial transfer〉							
Input data hold	T _{SH}	0.16	—	—	μs	—	—
Input data setup	T _{SS}	0.16	—	—	μs	—	—
Output data delay	T _D	—	—	0.3	μs	—	—
Input clock cycle	T _{SCYC}	0.5	—	—	μs	—	—
Input clock "H" width	T	40	—	60	%	Input clock cycle at minimum value	—

*2 Each of the high withstanding voltage output pins, pins 26 and 28 to 31, outputs the segment output current when set to the segment output and the grid current when set to the grid output.

●Measurement circuits

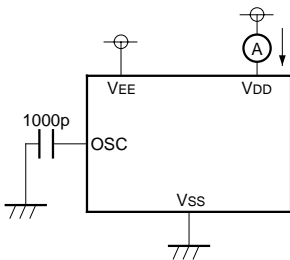

Fig.1

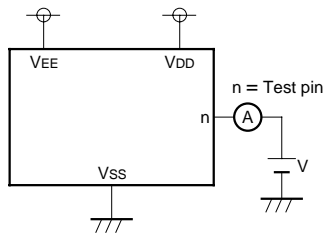

Fig.2

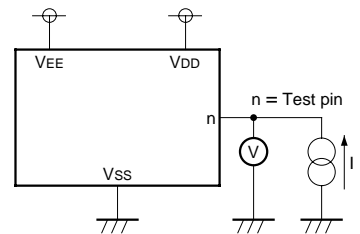

Fig.3

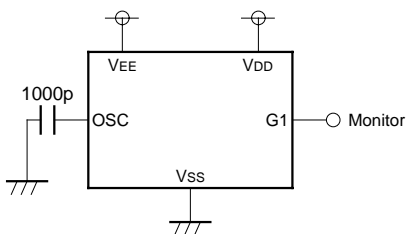

Fig.4

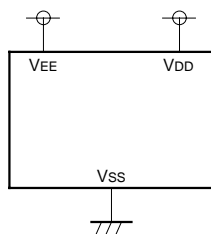

Fig.5

●Electrical characteristic curves

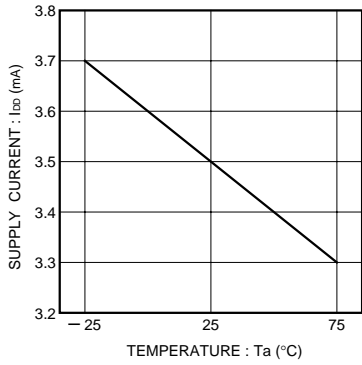

Fig.6 Supply current temperature characteristics

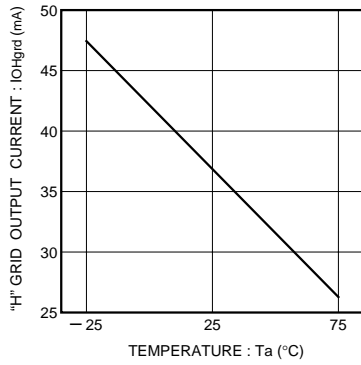

Fig.7 "H" grid output current temperature characteristics

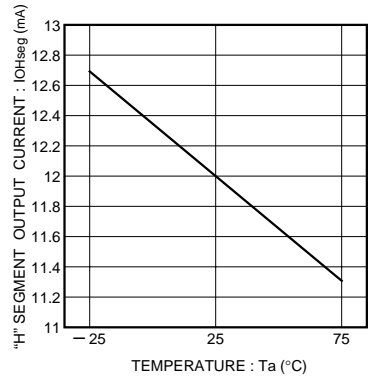

Fig.8 "H" segment output current temperature characteristics

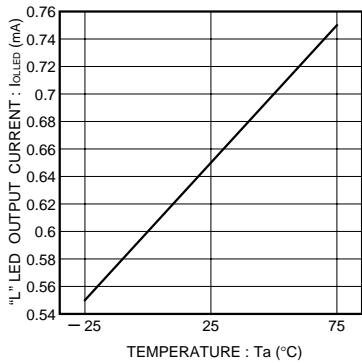

Fig.9 "L" LED output current temperature characteristics

●External dimensions (Units: mm)

