

IGBT With Antiparallel Diode

Preliminary data

- Low forward voltage drop
- High switching speed
- Low tail current
- Latch-up free
- Including fast free-wheel diode

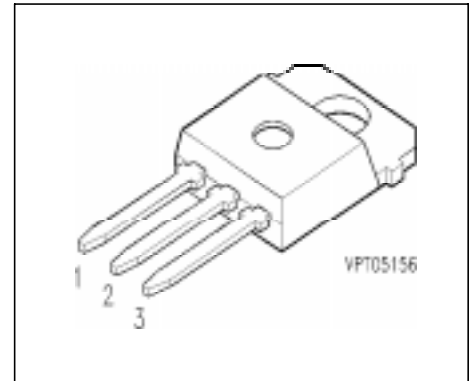

Pin 1	Pin 2	Pin 3
G	C	E

Type	V_{CE}	I_C	Package	Ordering Code
BUP 602D	600V	36A	TO-218 AB	Q67040-A4229-A2

Maximum Ratings

Parameter	Symbol	Values	Unit
Collector-emitter voltage	V_{CE}	600	V
Collector-gate voltage $R_{GE} = 20 \text{ k}\Omega$	V_{CGR}	600	
Gate-emitter voltage	V_{GE}	± 20	
DC collector current $T_C = 25 \text{ }^\circ\text{C}$ $T_C = 90 \text{ }^\circ\text{C}$	I_C	36 22	A
Pulsed collector current, $t_p = 1 \text{ ms}$ $T_C = 25 \text{ }^\circ\text{C}$ $T_C = 90 \text{ }^\circ\text{C}$	I_{Cpuls}	72 40	
Diode forward current $T_C = 90 \text{ }^\circ\text{C}$	I_F	31	
Pulsed diode current, $t_p = 1 \text{ ms}$ $T_C = 25 \text{ }^\circ\text{C}$	I_{Fpuls}	180	
Power dissipation $T_C = 25 \text{ }^\circ\text{C}$	P_{tot}	150	W
Chip or operating temperature	T_j	- 55 ... + 150	$^\circ\text{C}$
Storage temperature	T_{stg}	- 55 ... + 150	

Maximum Ratings

Parameter	Symbol	Values	Unit
DIN humidity category, DIN 40 040	-	E	-
IEC climatic category, DIN IEC 68-1	-	55 / 150 / 56	

Thermal Resistance

Thermal resistance, chip case	R_{thJC}	≤ 0.83	K/W
Diode thermal resistance, chip case	R_{thJCD}	≤ 1.5	

Electrical Characteristics, at $T_j = 25\text{ }^\circ\text{C}$, unless otherwise specified

Parameter	Symbol	Values			Unit
		min.	typ.	max.	

Static Characteristics

Gate threshold voltage $V_{GE} = V_{CE}, I_C = 0.5\text{ mA}$	$V_{GE(th)}$	4.5	5.5	6.5	V
Collector-emitter saturation voltage $V_{GE} = 15\text{ V}, I_C = 20\text{ A}, T_j = 25\text{ }^\circ\text{C}$	$V_{CE(sat)}$	-	2.1	2.7	
$V_{GE} = 15\text{ V}, I_C = 20\text{ A}, T_j = 125\text{ }^\circ\text{C}$		-	2.2	2.8	
$V_{GE} = 15\text{ V}, I_C = 40\text{ A}, T_j = 25\text{ }^\circ\text{C}$		-	3	-	
$V_{GE} = 15\text{ V}, I_C = 40\text{ A}, T_j = 125\text{ }^\circ\text{C}$		-	3.3	-	
Zero gate voltage collector current $V_{CE} = 600\text{ V}, V_{GE} = 0\text{ V}, T_j = 25\text{ }^\circ\text{C}$	I_{CES}	-	-	200	μA
Gate-emitter leakage current $V_{GE} = 25\text{ V}, V_{CE} = 0\text{ V}$	I_{GES}	-	-	100	nA

AC Characteristics

Transconductance $V_{CE} = 20\text{ V}, I_C = 20\text{ A}$	g_{fs}	4	-	-	S
Input capacitance $V_{CE} = 25\text{ V}, V_{GE} = 0\text{ V}, f = 1\text{ MHz}$	C_{iss}	-	1040	1400	pF
Output capacitance $V_{CE} = 25\text{ V}, V_{GE} = 0\text{ V}, f = 1\text{ MHz}$	C_{oss}	-	115	175	
Reverse transfer capacitance $V_{CE} = 25\text{ V}, V_{GE} = 0\text{ V}, f = 1\text{ MHz}$	C_{rss}	-	66	110	

Electrical Characteristics, at $T_j = 25\text{ °C}$, unless otherwise specified

Parameter	Symbol	Values			Unit
		min.	typ.	max.	

Switching Characteristics, Inductive Load at $T_j = 125\text{ °C}$

Turn-on delay time $V_{CC} = 300\text{ V}$, $V_{GE} = 15\text{ V}$, $I_C = 20\text{ A}$ $R_{Gon} = 47\text{ }\Omega$	$t_{d(on)}$	-	40	60	ns
Rise time $V_{CC} = 300\text{ V}$, $V_{GE} = 15\text{ V}$, $I_C = 20\text{ A}$ $R_{Gon} = 47\text{ }\Omega$	t_r	-	70	110	
Turn-off delay time $V_{CC} = 300\text{ V}$, $V_{GE} = -15\text{ V}$, $I_C = 20\text{ A}$ $R_{Goff} = 47\text{ }\Omega$	$t_{d(off)}$	-	250	330	
Fall time $V_{CC} = 300\text{ V}$, $V_{GE} = -15\text{ V}$, $I_C = 20\text{ A}$ $R_{Goff} = 47\text{ }\Omega$	t_f	-	500	680	

Free-Wheel Diode

Diode forward voltage $I_F = 20\text{ A}$, $V_{GE} = 0\text{ V}$, $T_j = 25\text{ °C}$ $I_F = 20\text{ A}$, $V_{GE} = 0\text{ V}$, $T_j = 125\text{ °C}$	V_F	-	1.8	-	V
		-	1.6	-	
Reverse recovery time $I_F = 20\text{ A}$, $V_R = -300\text{ V}$, $V_{GE} = 0\text{ V}$ $di_F/dt = -300\text{ A}/\mu\text{s}$, $T_j = 125\text{ °C}$	t_{rr}	-	110	160	ns
Reverse recovery charge $I_F = 20\text{ A}$, $V_R = -300\text{ V}$, $V_{GE} = 0\text{ V}$ $di_F/dt = -300\text{ A}/\mu\text{s}$ $T_j = 25\text{ °C}$ $T_j = 125\text{ °C}$	Q_{rr}	-	0.6	1.1	μC
		-	1.3	2.4	

Power dissipation

$$P_{\text{tot}} = f(T_C)$$

parameter: $T_j \leq 150^\circ\text{C}$

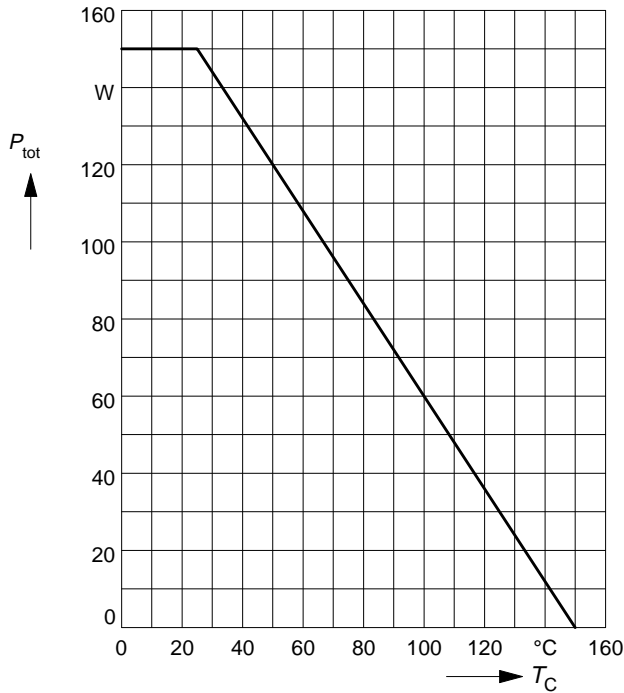

Collector current

$$I_C = f(T_C)$$

parameter: $V_{\text{GE}} \geq 15\text{ V}$, $T_j \leq 150^\circ\text{C}$

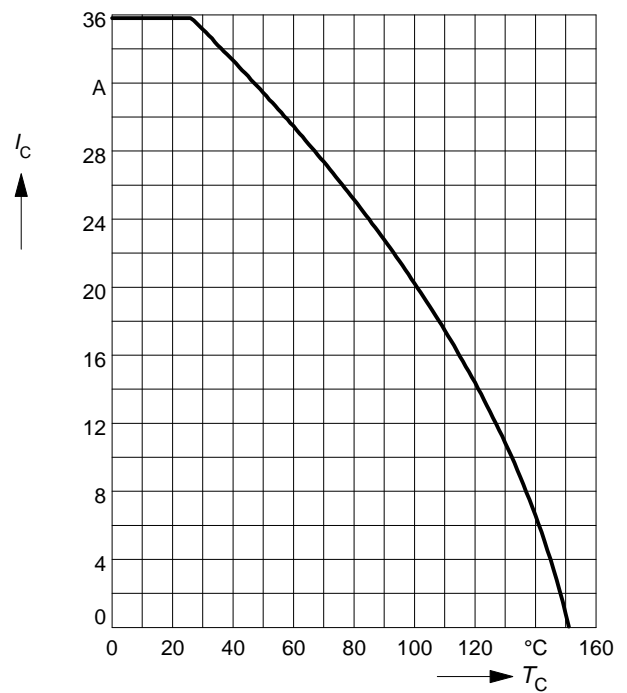

Safe operating area

$$I_C = f(V_{\text{CE}})$$

parameter: $D = 0$, $T_C = 25^\circ\text{C}$, $T_j \leq 150^\circ\text{C}$

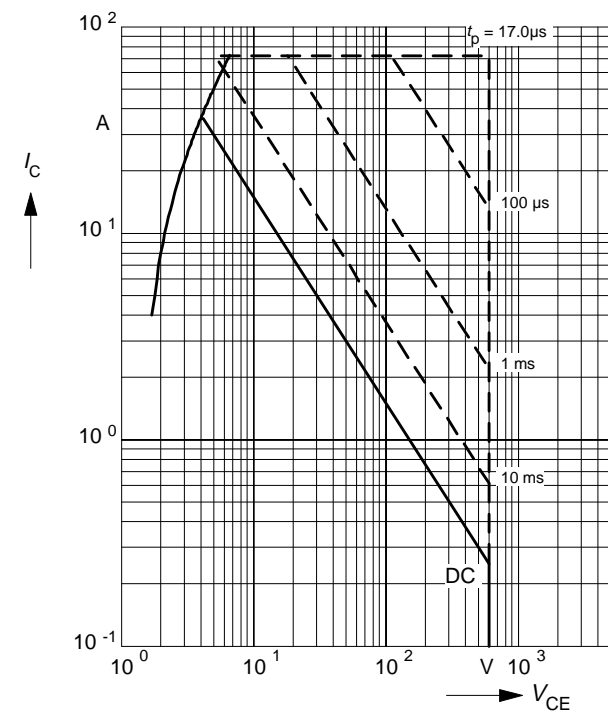

Transient thermal impedance IGBT

$$Z_{\text{thJC}} = f(t_p)$$

parameter: $D = t_p / T$

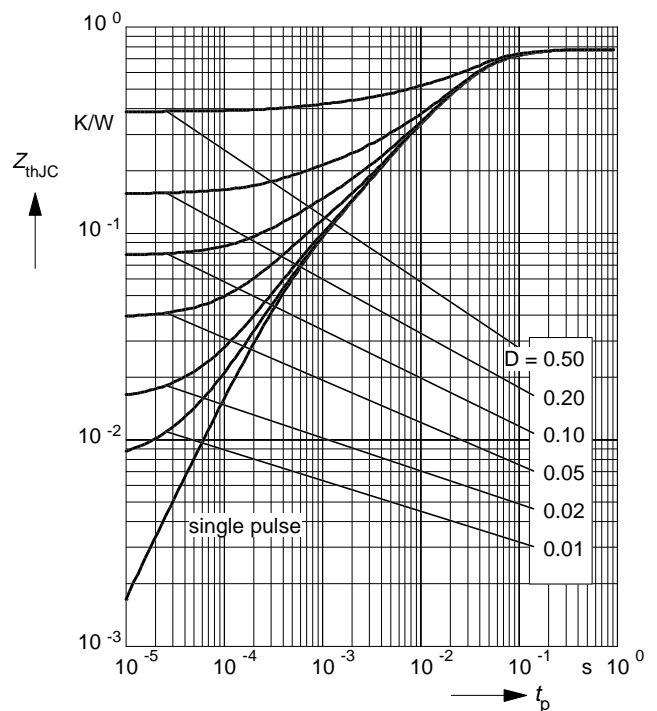

Typ. output characteristics

$$I_C = f(V_{CE})$$

parameter: $t_p = 80 \mu s, T_j = 25 \text{ }^\circ\text{C}$

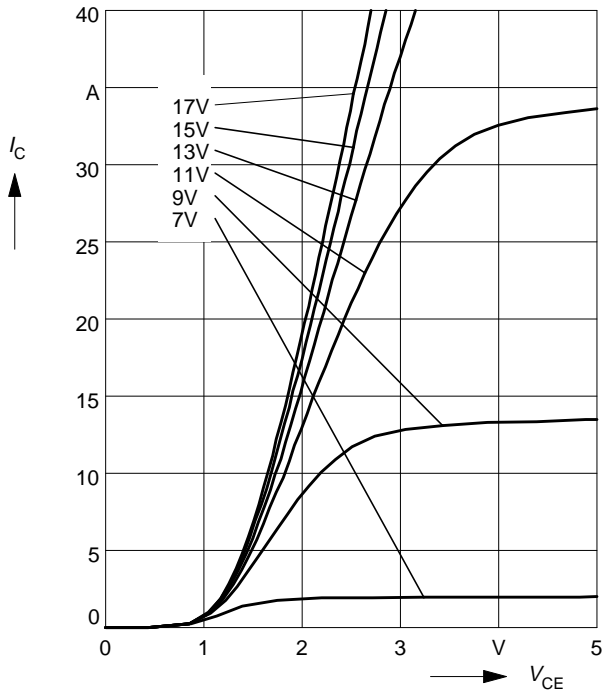

Typ. output characteristics

$$I_C = f(V_{CE})$$

parameter: $t_p = 80 \mu s, T_j = 125 \text{ }^\circ\text{C}$

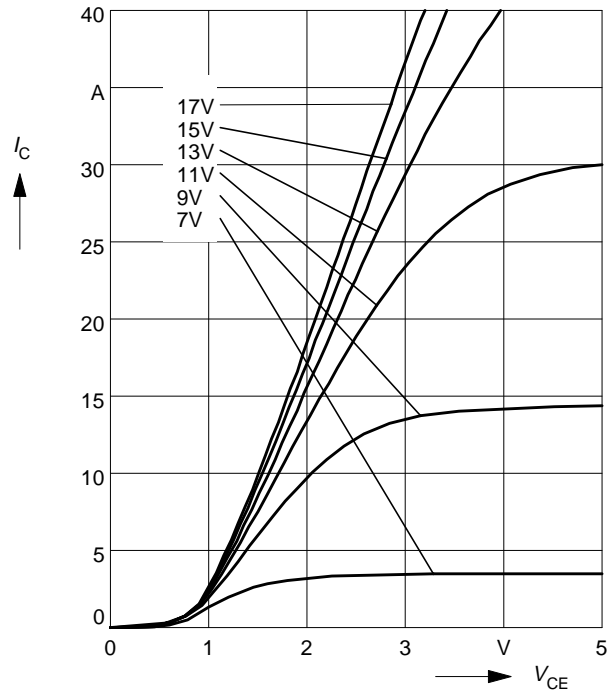

Typ. transfer characteristics

$$I_C = f(V_{GE})$$

parameter: $t_p = 80 \mu s, V_{CE} = 20 \text{ V}$

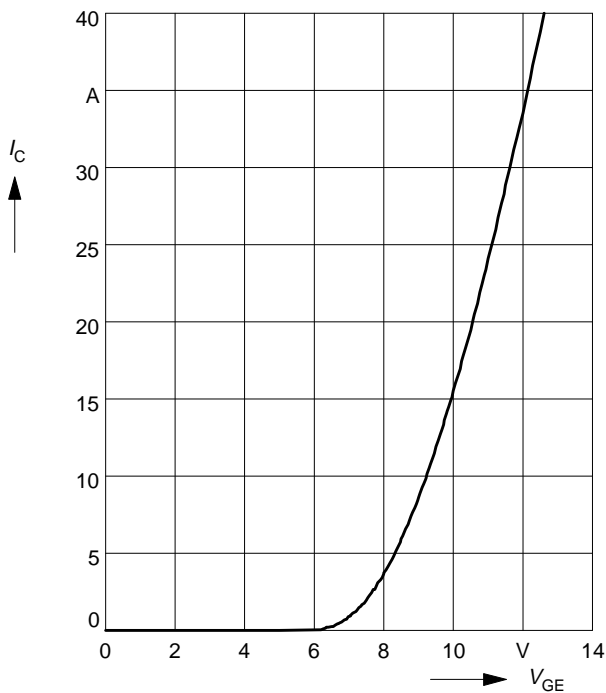

Typ. switching time

$t = f(I_C)$, inductive load, $T_j = 125^\circ\text{C}$
 par.: $V_{CE} = 300\text{ V}$, $V_{GE} = \pm 15\text{ V}$, $R_G = 47\ \Omega$

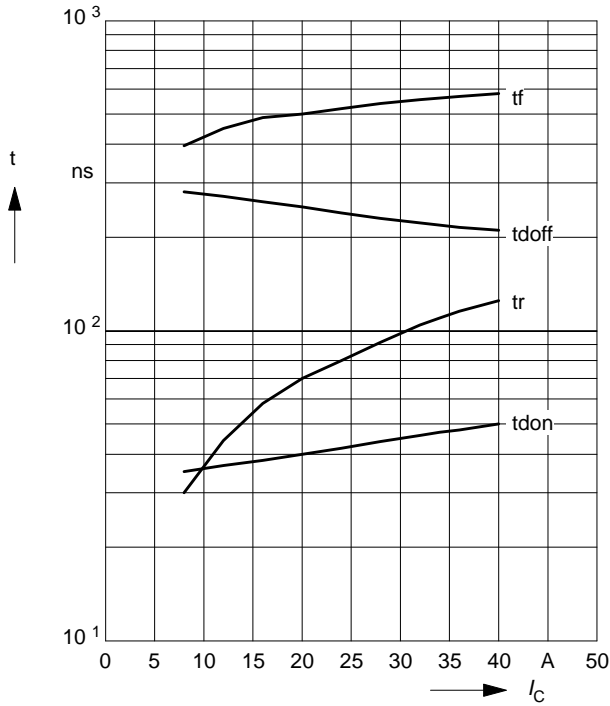

Typ. switching time

$t = f(R_G)$, inductive load, $T_j = 125^\circ\text{C}$
 par.: $V_{CE} = 300\text{ V}$, $V_{GE} = \pm 15\text{ V}$, $I_C = 20\text{ A}$

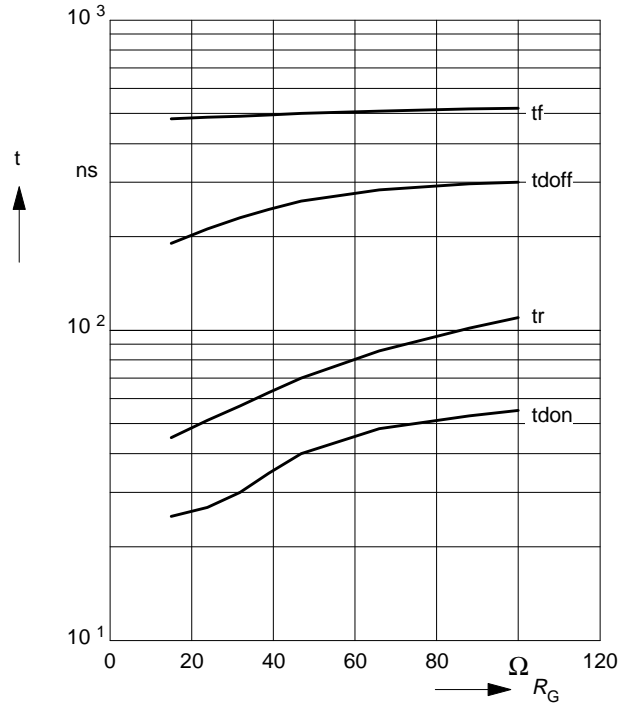

Typ. switching losses

$E = f(I_C)$, inductive load, $T_j = 125^\circ\text{C}$
 par.: $V_{CE} = 300\text{ V}$, $V_{GE} = \pm 15\text{ V}$, $R_G = 47\ \Omega$

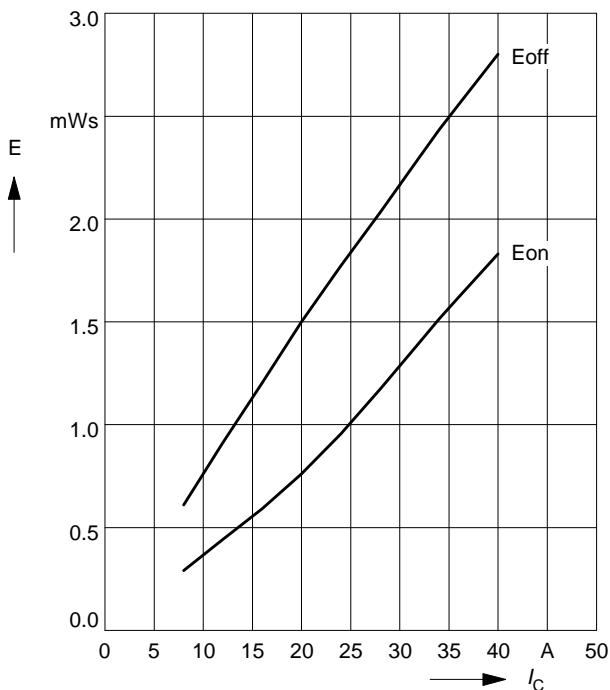

Typ. switching losses

$E = f(R_G)$, inductive load, $T_j = 125^\circ\text{C}$
 par.: $V_{CE} = 300\text{ V}$, $V_{GE} = \pm 15\text{ V}$, $I_C = 20\text{ A}$

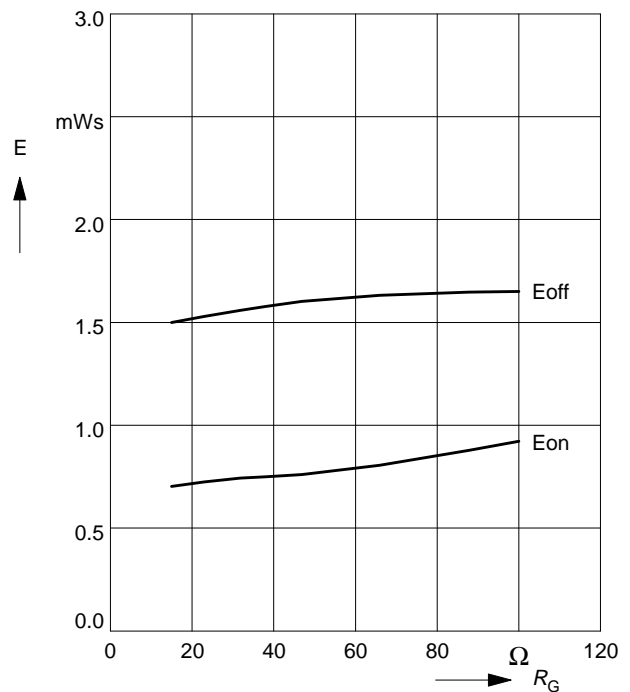

Typ. gate charge

$$V_{GE} = f(Q_{Gate})$$

parameter: $I_{C\ puls} = 20\ A$

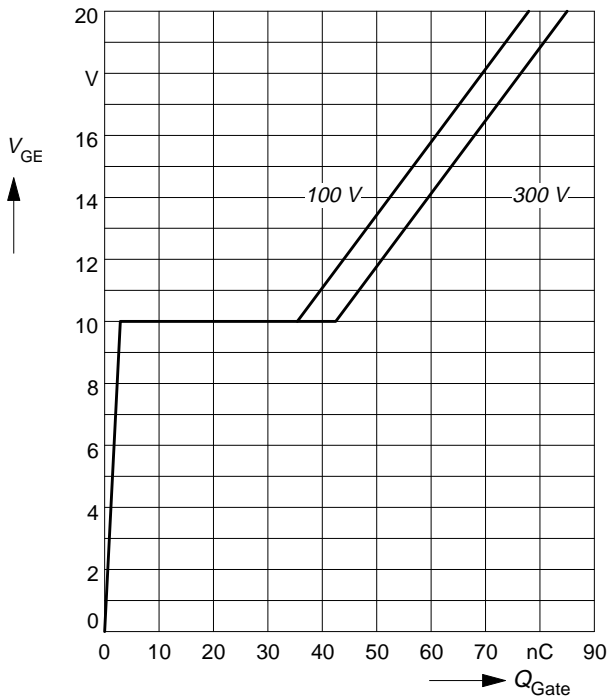

Typ. capacitances

$$C = f(V_{CE})$$

parameter: $V_{GE} = 0\ V, f = 1\ MHz$

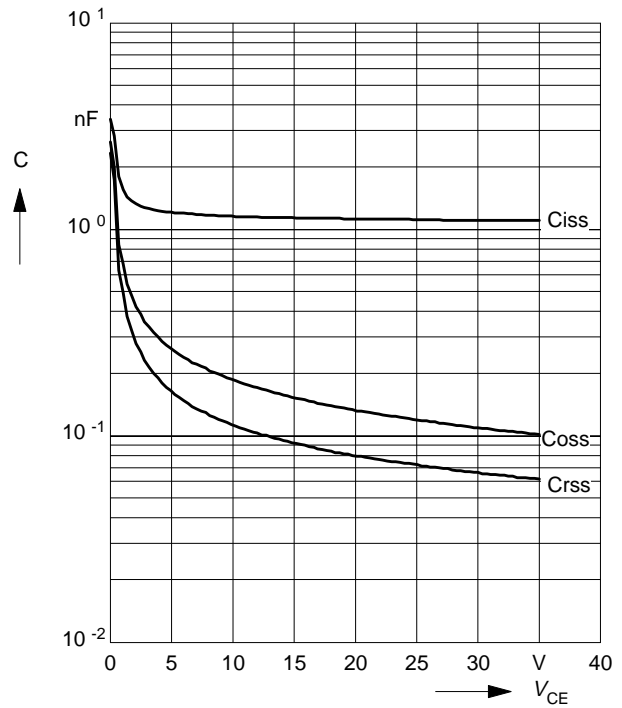

Short circuit safe operating area

$$I_{Csc} = f(V_{CE}), T_j = 150^\circ C$$

parameter: $V_{GE} = \pm 15\ V, t_{sc} \leq 10\ \mu s, L < 50\ nH$

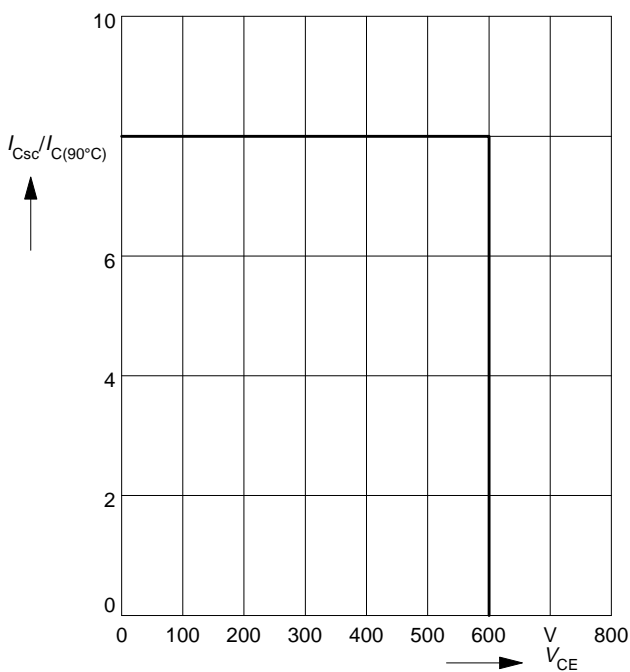

Reverse biased safe operating area

$$I_{Cpuls} = f(V_{CE}), T_j = 150^\circ C$$

parameter: $V_{GE} = 15\ V$

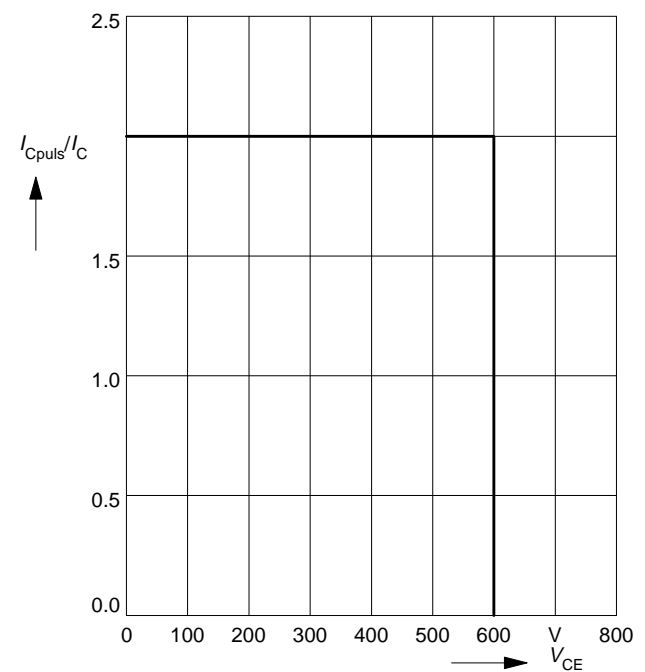

Typ. forward characteristics

$$I_F = f(V_F)$$

parameter: T_j

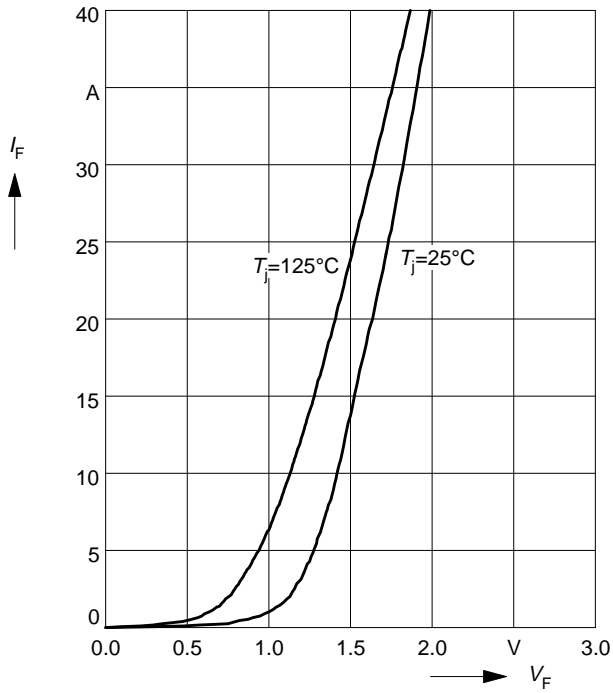

Transient thermal impedance Diode

$$Z_{thJC} = f(t_p)$$

parameter: $D = t_p / T$

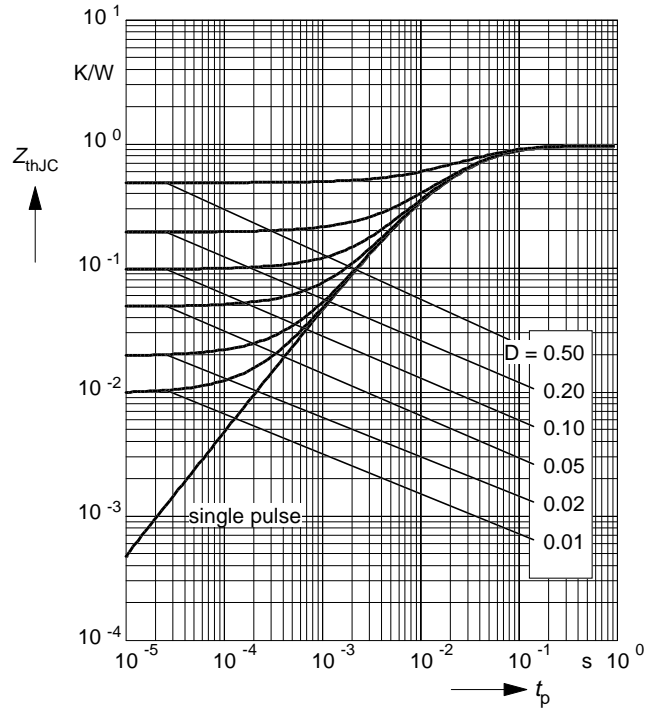

Package Outlines

Dimensions in mm

Weight:

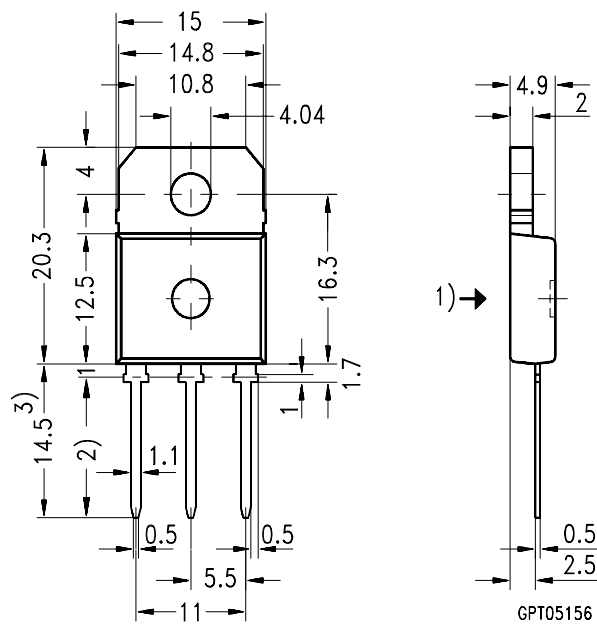

- 1) punch direction, burr max. 0.04
- 2) dip finning
- 3) max. 15.5 by dip finning press burr max. 0.05