

25C D ■ 8235605 0004872 3 ■ SIEG : T-33-09

**NPN Silicon High Voltage Switching Transistors**

**BUX 86**  
**BUX 87**

SIEMENS AKTIENGESELLSCHAFT

BUX 86 and BUX 87 are NPN silicon epibase power switching transistors in TO 126 plastic package (12 A 3 DIN 41869). They are outstanding for their short switching times and high dielectric strength and are particularly suitable for use in switching power supplies of TV sets. The collector is electrically connected to the metallic mounting area.

Type	Ordering code
BUX 86	Q68000-A3870
BUX 87	Q68000-A5167

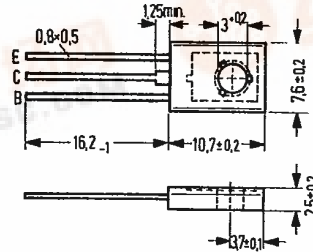

Approx. weight 0.5 g      Dimensions in mm

**Maximum ratings**

	BUX 86	BUX 87	
Collector-emitter voltage	$V_{CES}$ 800	1000	V
Collector-emitter voltage	$V_{CEO}$ 400	450	V
Collector current	$I_C$ 0.5	0.5	A
Collector peak current ( $t_p \leq 2$ ms)	$I_{CM}$ 1.0	1.0	A
Base current	$I_B$ 0.2	0.2	A
Base peak current	$I_{BM}$ 0.3	0.3	A
Negative base peak current at turning off	$-I_{BM}$ 0.3	0.3	A
Storage temperature range	$T_{stg}$ -65 to +150		°C
Junction temperature	$T_j$ 150	150	°C
Total power dissipation ( $T_{case} \leq 60^\circ C$ )	$P_{tot}$ 20	20	W

**Thermal resistance**

Junction to mounting area	$R_{thJC}$ $\leq 4.5$	$\leq 4.5$	K/W
---------------------------	-----------------------	------------	-----

918

2234

F-03

## SIEMENS AKTIENGESELLSCHAFT

Static characteristics ( $T_{amb} = 25^{\circ}\text{C}$ )		BUX 86	BUX 87	
Collector-emitter breakdown voltage ( $I_C = 100\text{ mA}$ ; $I_B = 0$ ; $L = 25\text{ mH}$ )	$V_{(BR)CEO}$	$\geq 400$	$\geq 450$	V
Collector cutoff current ( $V_{CES} = 800\text{ V}$ )	$I_{CES}$	$< 0.1$	–	mA
( $V_{CES} = 800\text{ V}$ ; $T_J = 150^{\circ}\text{C}$ )	$I_{CES}$	$< 1$	–	mA
( $V_{CES} = 1000\text{ V}$ )	$I_{CES}$	–	$< 0.1$	mA
( $V_{CES} = 1000\text{ V}$ ; $T_J = 150^{\circ}\text{C}$ )	$I_{CES}$	–	$< 1$	mA
Emitter cutoff current ( $V_{EBO} = 5\text{ V}$ )	$I_{EBO}$	$< 1$	$< 1$	mA
DC current gain ( $V_{CE} = 5\text{ V}$ ; $I_C = 50\text{ mA}$ )	$h_{FE}$	50	50	–
Collector-emitter saturation voltage ( $I_C = 100\text{ mA}$ ; $I_B = 10\text{ mA}$ )	$V_{CEsat}$	$< 1.5$	$< 1.5$	V
( $I_C = 200\text{ mA}$ ; $I_B = 20\text{ mA}$ )	$V_{CEsat}$	$< 3$	$< 3$	V
Base-emitter saturation voltage ( $I_C = 200\text{ mA}$ ; $I_B = 20\text{ mA}$ )	$V_{BEsat}$	$< 1$	$< 1$	V
<b>Dynamic characteristics (<math>T_{amb} = 25^{\circ}\text{C}</math>)</b>				
Transition frequency ( $V_{CE} = 10\text{ V}$ ; $I_C = 50\text{ mA}$ ; $f = 1\text{ MHz}$ )	$f_T$	20	20	MHz
Switching times ( $V_{CC} = 250\text{ V}$ ; $I_C = 200\text{ mA}$ ; $I_B = 20\text{ mA}$ ; $-I_B = 40\text{ mA}$ )				
Turn-on time	$t_{on}$	0.25 ( $< 0.5$ )	0.25 ( $< 0.5$ )	$\mu\text{s}$
Storage time	$t_s$	2 ( $< 3.5$ )	2 ( $< 3.5$ )	$\mu\text{s}$
Fall time <sup>1)</sup>	$t_f$	0.4	0.4	$\mu\text{s}$

1) at  $T_{case} = 95^{\circ}\text{C}$  is  $t_f \leq 1.4\ \mu\text{s}$

SIEMENS AKTIENGESELLSCHAFT

Total perm. power dissipation  
versus temperature

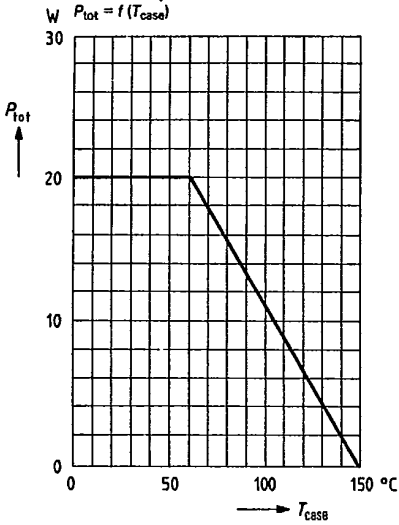

Permissible pulse load  
 $Z_{thJC} = f(t); v = \text{parameter}$

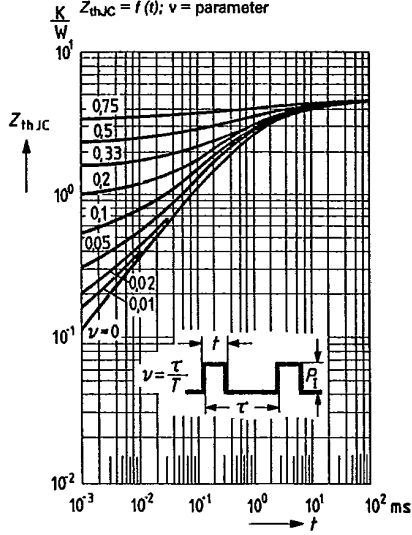

Permissible operating range  
 $I_C = f(V_{CE}); T_{case} \leq 60^\circ\text{C}$

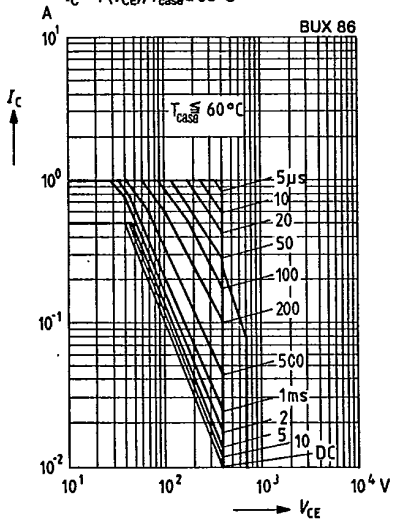

Permissible operating range  
 $I_C = f(V_{CE}); T_{case} \leq 60^\circ\text{C}$

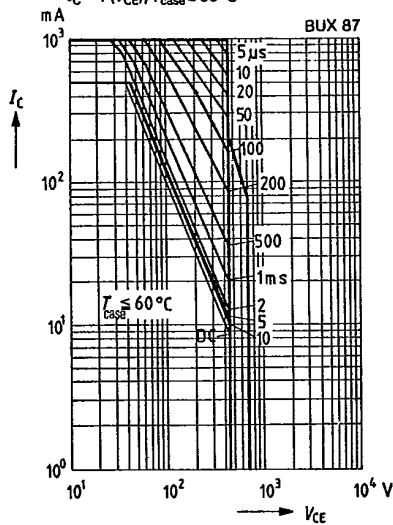

25C D ■ 8235605 0004875 9 ■ SIEG  
 25C 04875 DT-33-09

BUX 86  
 BUX 87

SIEMENS AKTIENGESELLSCHAFT

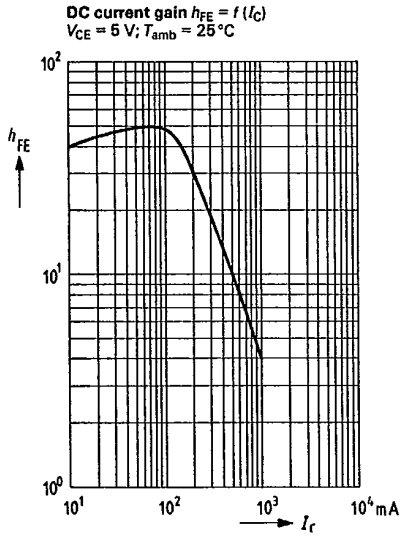

Test circuit for breakdown voltage  $V_{(BR)CEO}$

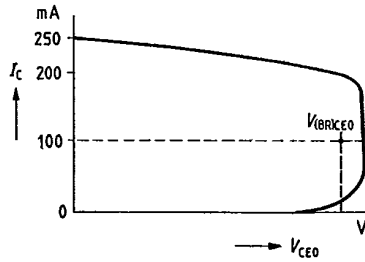
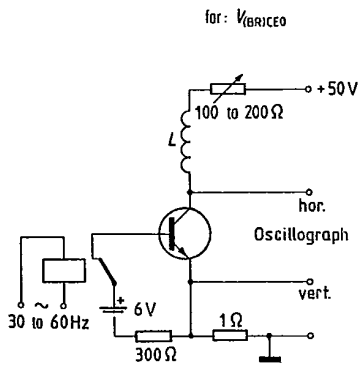

2237

F-06

921

- SIEMENS AKTIENGESELLSCHAFT

Test circuit for switching times

