

Dual LDO with Low Noise, Low I_Q, and High PSRR

ISL9012 is a high performance dual LDO capable of sourcing 150mA current from channel 1 and 300mA from channel 2. The device has a low standby current and high-PSRR and is stable with output capacitance of 1 μ F to 10 μ F with ESR of up to 200m Ω .

The device integrates a Power-On-Reset (POR) function for the VO2 output. The POR delay for VO2 can be externally programmed by connecting a timing capacitor to the CPOR pin. A reference bypass pin is also provided for connecting a noise-filtering capacitor for low noise and high PSRR applications.

The quiescent current is typically only 45 μ A with both LDO's enabled and active. Separate enable pins control each individual LDO output. When both enable pins are low, the device is in shutdown, typically drawing less than 0.1 μ A.

Several combinations of voltage outputs are standard. Others are available on request. Output voltage options for each LDO range from 1.2V to 3.6V.

Pinout

ISL9012
10-PIN 3X3 DFN
TOP VIEW

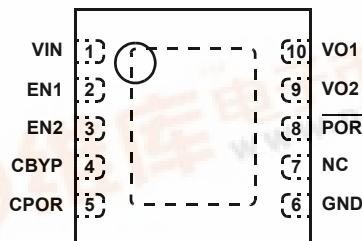

Features

- Integrates two high performance LDOs
 - VO1 - 150mA output
 - VO2 - 300mA output
- Excellent transient response to large current steps
- Excellent load regulation:
 - <1% voltage change across full range of load current
- High PSRR: 70dB @ 1kHz
- Wide input voltage capability: 2.3V - 6.5V
- Extremely low quiescent current: 45 μ A (both LDOs on)
- Low dropout voltage: typically 120mV @ 150mA
- Low output noise: typically 30 μ Vrms @ 100 μ A(1.5V)
- Stable with 1-10 μ F ceramic capacitors
- Separate enable pins for each LDO
- POR output, with adjustable delay time indicates when the VO2 output is good
- Soft-start to limit input current surge during enable
- Current limit and overheat protection
- \pm 1.8% accuracy over all operating conditions
- Tiny 10 Ld 3x3mm DFN package
- -40°C to +85°C operating temperature range
- Pin compatible with Micrel MIC2212
- Pb-free plus anneal available (RoHS compliant)

Applications

- PDAs, Cell Phones and Smart Phones
- Portable Instruments, MP3 Players
- Handheld Devices including Medical Handhelds

ISL9012

Ordering Information

PART NUMBER (Notes 1, 2, 3)	PART MARKING	VO1 VOLTAGE	VO2 VOLTAGE	TEMP RANGE (°C)	PACKAGE (Pb-free)	PKG. DWG. #
ISL9012IRNJZ	DAPA	3.3V	2.8V	-40 to +85	10 Ld 3x3 DFN	L10.3x3C
ISL9012IRNFZ	DARA	3.3V	2.5V	-40 to +85	10 Ld 3x3 DFN	L10.3x3C
ISL9012IRMMZ	DAAK	3.0V	3.0V	-40 to +85	10 Ld 3x3 DFN	L10.3x3C
ISL9012IRLLZ	DAAJ	2.9V	2.9V	-40 to +85	10 Ld 3x3 DFN	L10.3x3C
ISL9012IRKKZ	DASA	2.85V	2.85V	-40 to +85	10 Ld 3x3 DFN	L10.3x3C
ISL9012IRKJZ	DATA	2.85V	2.8V	-40 to +85	10 Ld 3x3 DFN	L10.3x3C
ISL9012IRKFZ	DAVA	2.85V	2.5V	-40 to +85	10 Ld 3x3 DFN	L10.3x3C
ISL9012IRKCZ	DAAB	2.85V	1.8V	-40 to +85	10 Ld 3x3 DFN	L10.3x3C
ISL9012IRJMZ	DAAH	2.8V	3.0V	-40 to +85	10 Ld 3x3 DFN	L10.3x3C
ISL9012IRJRZ	DAAG	2.8V	2.6V	-40 to +85	10 Ld 3x3 DFN	L10.3x3C
ISL9012IRJCZ	DAAF	2.8V	1.8V	-40 to +85	10 Ld 3x3 DFN	L10.3x3C
ISL9012IRJBZ	DAWA	2.8V	1.5V	-40 to +85	10 Ld 3x3 DFN	L10.3x3C
ISL9012IRGCZ	DAAE	2.7V	1.8V	-40 to +85	10 Ld 3x3 DFN	L10.3x3C
ISL9012IRFJZ	DAYA	2.5V	2.8V	-40 to +85	10 Ld 3x3 DFN	L10.3x3C
ISL9012IRPLZ	DAAD	1.85V	2.9V	-40 to +85	10 Ld 3x3 DFN	L10.3x3C
ISL9012IRBJZ	DAAC	1.5V	2.8V	-40 to +85	10 Ld 3x3 DFN	L10.3x3C

NOTES:

1. Add -T to part number for tape and reel.
2. For other output voltages, contact Intersil Marketing.
3. Intersil Pb-free plus anneal products employ special Pb-free material sets; molding compounds/die attach materials and 100% matte tin plate termination finish, which are RoHS compliant and compatible with both SnPb and Pb-free soldering operations. Intersil Pb-free products are MSL classified at Pb-free peak reflow temperatures that meet or exceed the Pb-free requirements of IPC/JEDEC J STD-020.

ISL9012

Absolute Maximum Ratings

Supply Voltage (VIN)	+7.1V
All Other Pins	-0.3 to (VIN+0.3)V

Recommended Operating Conditions

Ambient Temperature Range (TA)	-40°C to +85°C
Supply Voltage (VIN)	2.3 to 6.5V

Thermal Information

Thermal Resistance (Notes 1, 2)	θ_{JA} (°C/W)	θ_{JC} (°C/W)
3x3 DFN Package	50	10
Junction Temperature Range	-40°C to +125°C	
Operating Temperature Range	-40°C to +85°C	
Storage Temperature Range	-65°C to +150°C	
Maximum Lead Temperature (Soldering 10s)	+300°C	

CAUTION: Stresses above those listed in "Absolute Maximum Ratings" may cause permanent damage to the device. This is a stress only rating and operation of the device at these or any other conditions above those indicated in the operational sections of this specification is not implied.

NOTES:

- θ_{JA} is measured in free air with the component mounted on a high effective thermal conductivity test board with "direct attach" features. See Tech Brief TB379.
- θ_{JC} , "case temperature" location is at the center of the exposed metal pad on the package underside. See Tech Brief TB379.

Electrical Specifications

Unless otherwise noted, all parameters are guaranteed over the operational supply voltage and temperature range of the device as follows:
 $T_A = -40^\circ\text{C}$ to $+85^\circ\text{C}$; $V_{IN} = (V_O + 0.5\text{V})$ to 6.5V with a minimum V_{IN} of 2.3V; $C_{IN} = 1\mu\text{F}$; $C_O = 1\mu\text{F}$;
 $C_{BYP} = 0.01\mu\text{F}$; $C_{POR} = 0.01\mu\text{F}$

PARAMETER	SYMBOL	TEST CONDITIONS	MIN	TYP	MAX	UNITS				
DC CHARACTERISTICS										
Supply Voltage	V_{IN}		2.3		6.5	V				
Ground Current		Quiescent condition: $I_{O1} = 0\mu\text{A}$; $I_{O2} = 0\mu\text{A}$								
	I_{DD1}	One LDO active		25	40	μA				
	I_{DD2}	Both LDO active		45	60	μA				
Shutdown Current	I_{DDS}	@25°C		0.1	1.0	μA				
UVLO Threshold	V_{UV+}		1.9	2.1	2.3	V				
	V_{UV-}		1.6	1.8	2.0	V				
Regulation Voltage Accuracy		Variation from nominal voltage output, $V_{IN} = V_O + 0.5$ to 5.5V, $T_J = -40^\circ\text{C}$ to 125°C	-1.8		+1.8	%				
Line Regulation		$V_{IN} = (V_{OUT} + 1.0\text{V}$ relative to highest output voltage) to 5.5V	-0.2	0	0.2	%/V				
Load Regulation		$I_{OUT} = 100\mu\text{A}$ to 150mA (VO1 and VO2)		0.1	0.7	%				
		$I_{OUT} = 100\mu\text{A}$ to 300mA (VO2)			1.0	%				
Maximum Output Current	I_{MAX}	VO1: Continuous	150			mA				
		VO2: Continuous	300			mA				
Internal Current Limit	I_{LIM}		350	475	600	mA				
Dropout Voltage (Note 4)	V_{DO1}	$I_O = 150\text{mA}$; $V_O > 2.1\text{V}$ (VO1)		125	200	mV				
	V_{DO2}	$I_O = 300\text{mA}$; $V_O < 2.5\text{V}$ (VO2)		300	500	mV				
	V_{DO3}	$I_O = 300\text{mA}$; $2.5\text{V} \leq V_O \leq 2.8\text{V}$ (VO2)		250	400	mV				
	V_{DO4}	$I_O = 300\text{mA}$; $V_O > 2.8\text{V}$ (VO2)		200	325	mV				
Thermal Shutdown Temperature	T_{SD+}			145		°C				
	T_{SD-}			110		°C				
AC CHARACTERISTICS										
Ripple Rejection		$I_O = 10\text{mA}$, $V_{IN} = 2.8\text{V}(\text{min})$, $V_O = 1.8\text{V}$, $C_{BYP} = 0.1\mu\text{F}$								
							@ 1kHz	70		dB
							@ 10kHz	55		dB
							@ 100kHz	40		dB
Output Noise Voltage		$I_O = 100\mu\text{A}$, $V_O = 1.5\text{V}$, $T_A = 25^\circ\text{C}$, $C_{BYP} = 0.1\mu\text{F}$ BW = 10Hz to 100kHz (Note 3)		30		μV_{rms}				

ISL9012

Electrical Specifications Unless otherwise noted, all parameters are guaranteed over the operational supply voltage and temperature range of the device as follows:
 $T_A = -40^{\circ}\text{C}$ to $+85^{\circ}\text{C}$; $V_{IN} = (V_O + 0.5\text{V})$ to 6.5V with a minimum V_{IN} of 2.3V ; $C_{IN} = 1\mu\text{F}$; $C_O = 1\mu\text{F}$;
 $C_{BYP} = 0.01\mu\text{F}$; $C_{POR} = 0.01\mu\text{F}$ **(Continued)**

PARAMETER	SYMBOL	TEST CONDITIONS	MIN	TYP	MAX	UNITS
DEVICE START-UP CHARACTERISTICS						
Device Enable Time	T_{EN}	Time from assertion of the ENx pin to when the output voltage reaches 95% of the $V_{O(nom)}$		250	500	μs
LDO Soft-start Ramp Rate	T_{SSR}	Slope of linear portion of LDO output voltage ramp during start-up		30	60	$\mu\text{s}/\text{V}$
EN1, EN2 PIN CHARACTERISTICS						
Input Low Voltage	V_{IL}		-0.3		0.5	V
Input High Voltage	V_{IH}		1.4		$V_{IN} + 0.3$	V
Input Leakage Current	I_{IL}, I_{IH}				0.1	μA
Pin Capacitance	C_{PIN}	Informative		5		pF
POR PIN CHARACTERISTICS						
$\overline{\text{POR}}$ Thresholds	V_{POR+}	As a percentage of nominal output voltage	91	94	97	%
	V_{POR-}		87	90	93	%
$\overline{\text{POR}}$ Delay	T_{PLH}	$C_{POR} = 0.01\mu\text{F}$	100	200	300	ms
	T_{PHL}			25		μs
$\overline{\text{POR}}$ Pin Output Low Voltage	V_{OL}	@ $I_{OL} = 1.0\text{mA}$			0.2	V
$\overline{\text{POR}}$ Pin Internal Pull-up Resistance	R_{POR}		78	100	130	$\text{k}\Omega$

NOTES:

3. Guaranteed by design and characterization.
4. $V_{OX} = 0.98 * V_{OX(NOM)}$; Valid for V_{OX} greater than 1.85V.

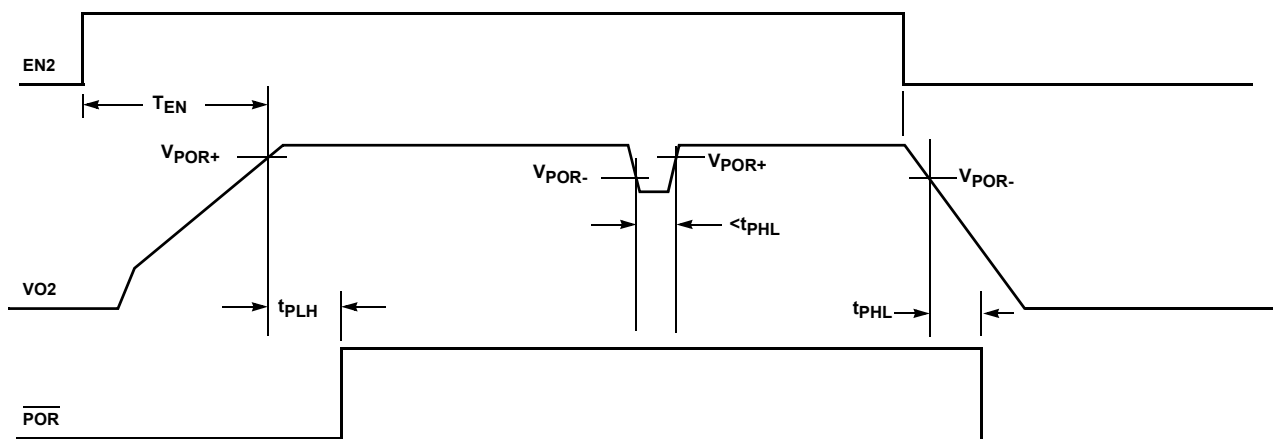

FIGURE 1. TIMING PARAMETER DEFINITION

Typical Performance Curves

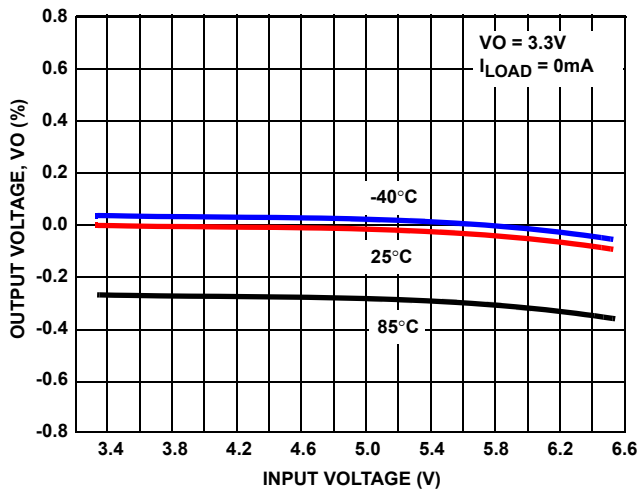

FIGURE 2. OUTPUT VOLTAGE vs INPUT VOLTAGE (3.3V OUTPUT)

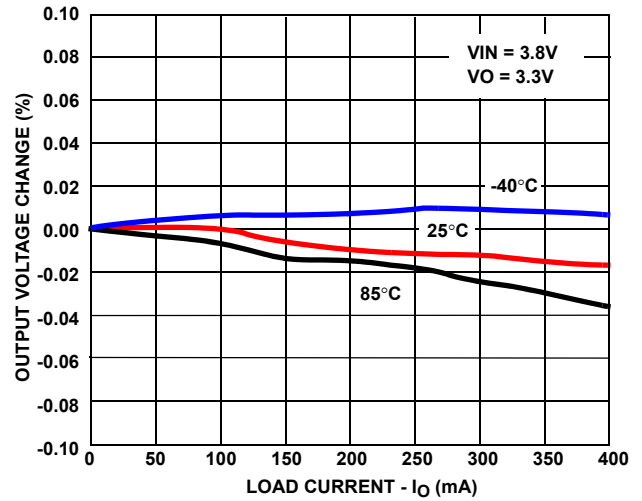

FIGURE 3. OUTPUT VOLTAGE CHANGE vs LOAD CURRENT

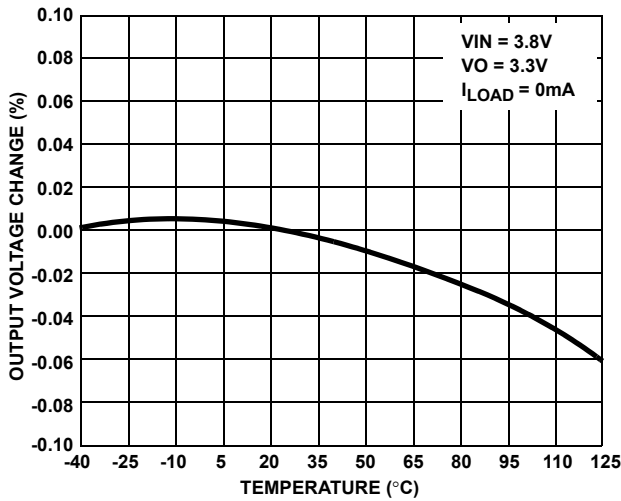

FIGURE 4. OUTPUT VOLTAGE CHANGE vs TEMPERATURE

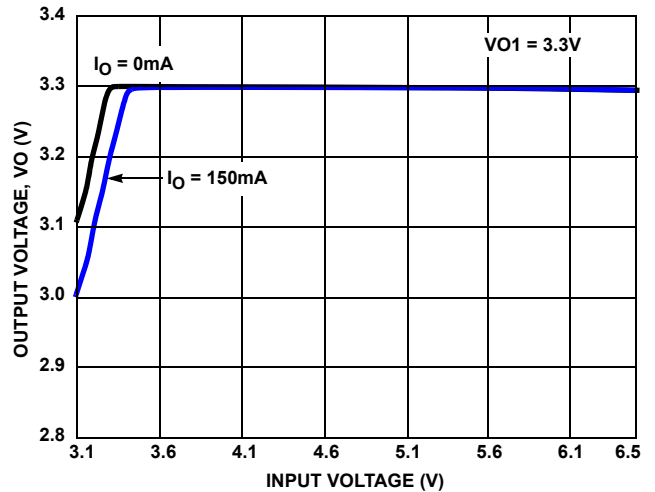

FIGURE 5. OUTPUT VOLTAGE vs INPUT VOLTAGE ($V_{O1} = 3.3V$)

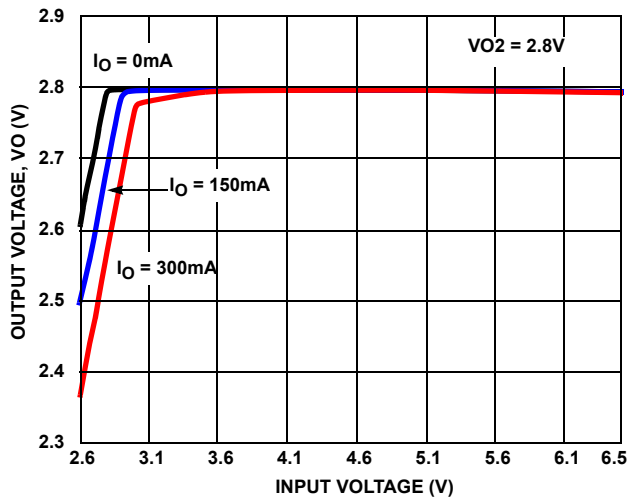

FIGURE 6. OUTPUT VOLTAGE vs INPUT VOLTAGE ($V_{O2} = 2.8V$)

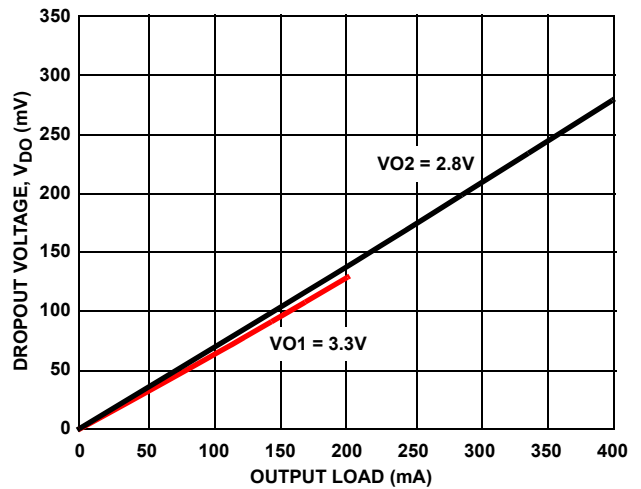

FIGURE 7. V_{O1} DROPOUT VOLTAGE vs LOAD CURRENT

Typical Performance Curves (Continued)

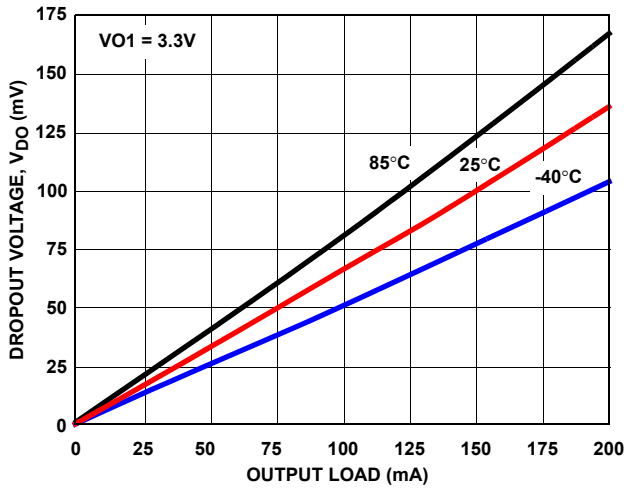

FIGURE 8. VO1 DROPOUT VOLTAGE vs LOAD CURRENT

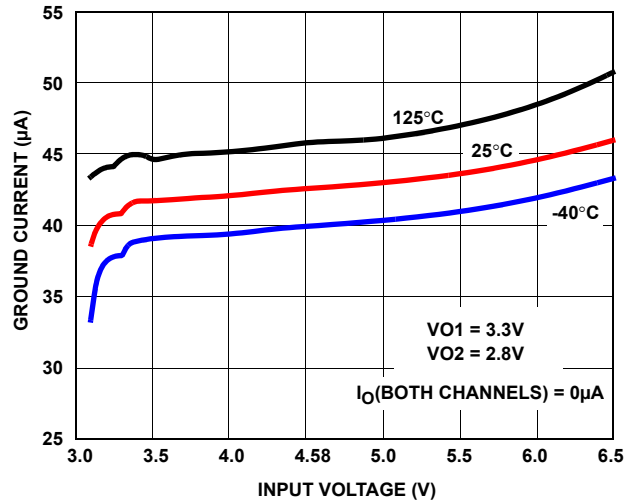

FIGURE 9. GROUND CURRENT vs INPUT VOLTAGE

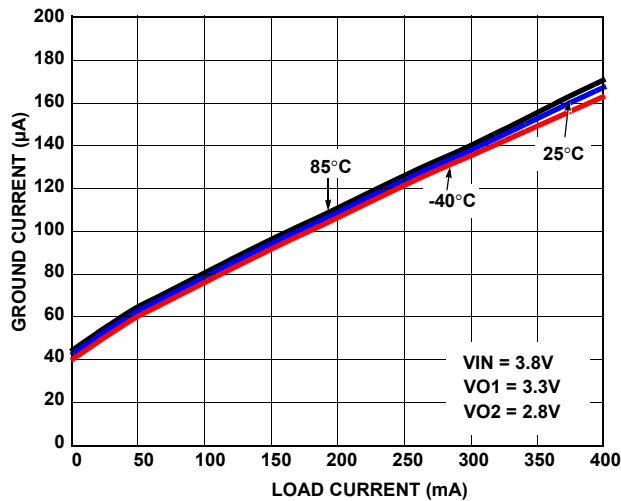

FIGURE 10. GROUND CURRENT vs LOAD

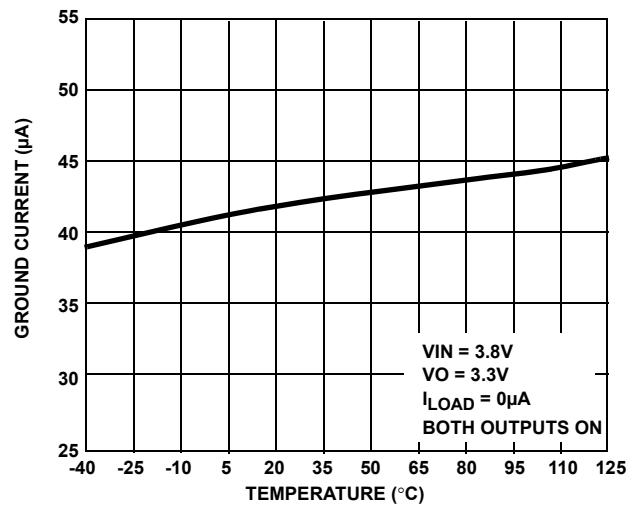

FIGURE 11. GROUND CURRENT vs TEMPERATURE

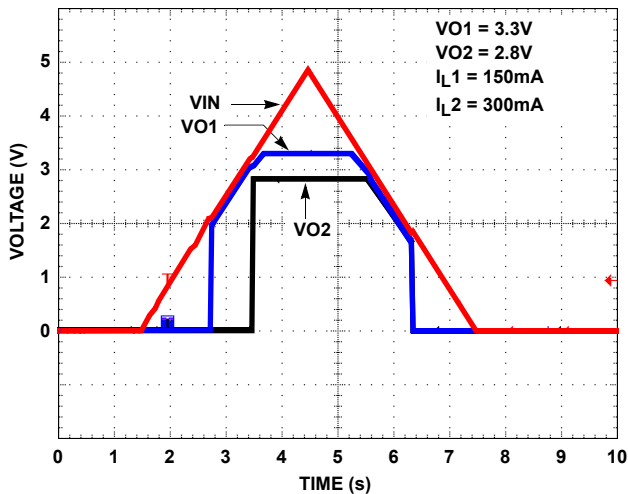

FIGURE 12. POWER-UP/POWER-DOWN

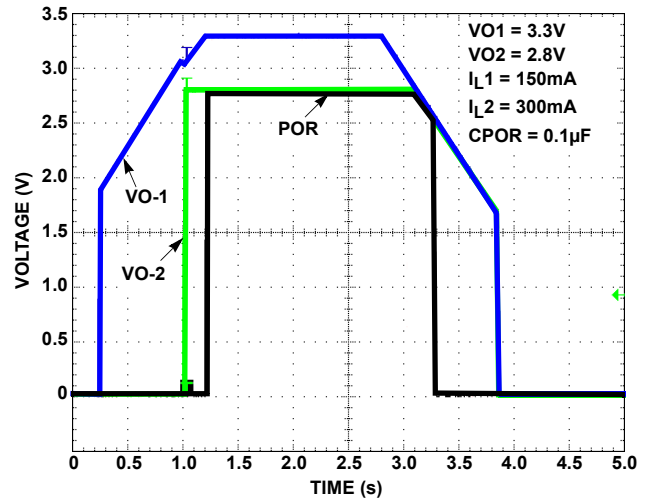

FIGURE 13. POWER-UP/POWER-DOWN WITH POR SIGNALS

Typical Performance Curves (Continued)

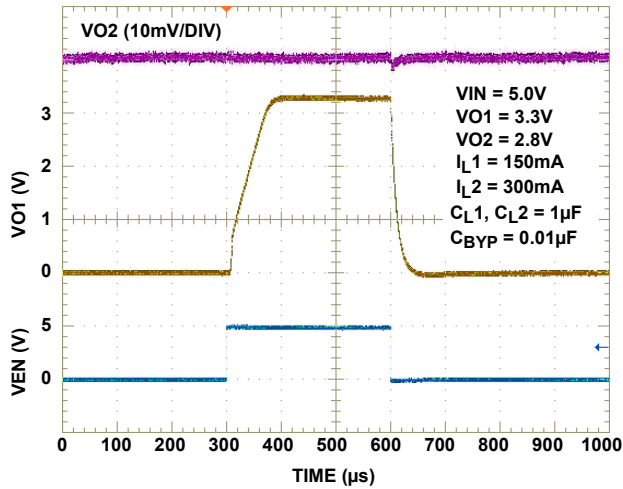

FIGURE 14. TURN ON/TURN OFF RESPONSE

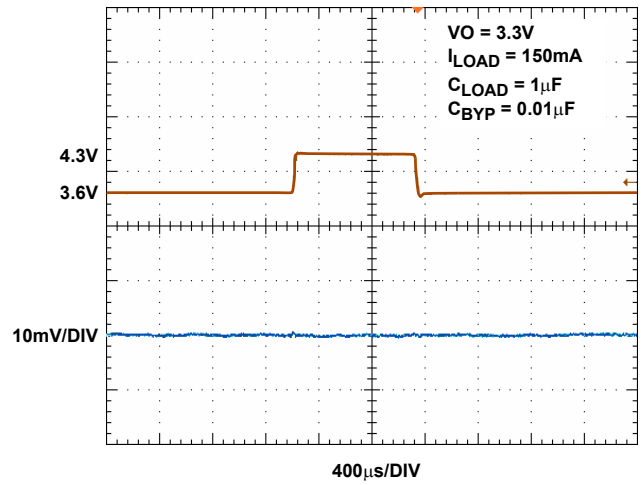

FIGURE 15. LINE TRANSIENT RESPONSE, 3.3V OUTPUT

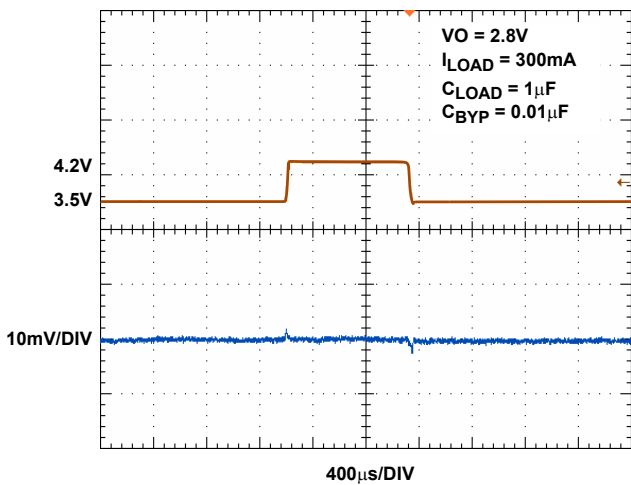

FIGURE 16. LINE TRANSIENT RESPONSE, 2.8V OUTPUT

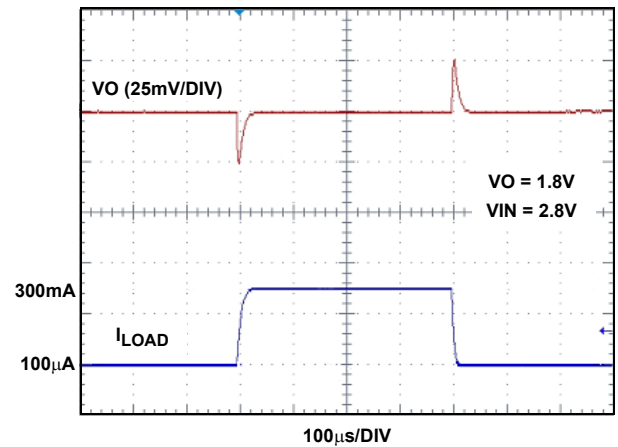

FIGURE 17. LOAD TRANSIENT RESPONSE

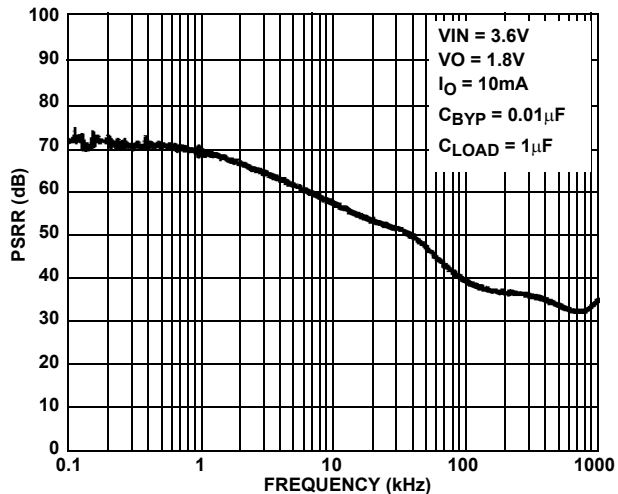

FIGURE 18. PSRR vs FREQUENCY

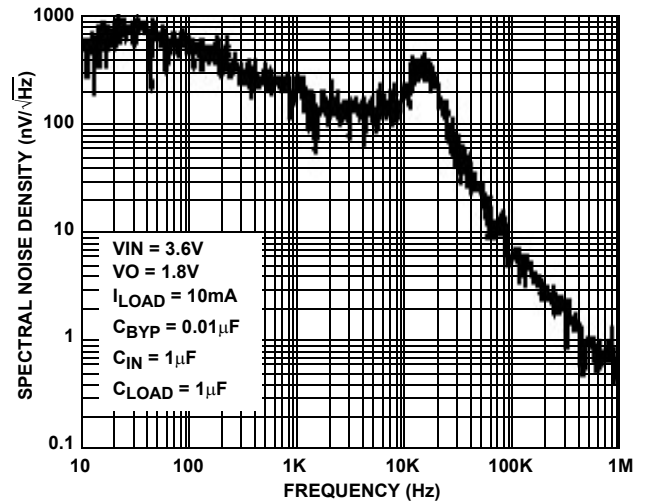

FIGURE 19. SPECTRAL NOISE DENSITY vs FREQUENCY

ISL9012

Pin Description

PIN #	PIN NAME	TYPE	DESCRIPTION
1	VIN	Analog I/O	Supply Voltage / LDO Input: Connect a 1 μ F capacitor to GND.
2	EN1	Low Voltage Compatible CMOS Input	LDO-1 Enable.
3	EN2	Low Voltage Compatible CMOS Input	LDO-2 Enable.
4	CBYP	Analog I/O	Reference Bypass Capacitor Pin: Optionally connect capacitor of value 0.01 μ F to 1 μ F between this pin and GND to tune in the desired noise and PSRR performance.
5	CPOR	Analog I/O	POR Delay Setting Capacitor Pin: Connect a capacitor between this pin and GND to delay the $\overline{\text{POR}}$ output release after LDO-2 output reaches 94% of its specified voltage level (200ms delay per 0.01 μ F).
6	GND	Ground	GND is the connection to system ground. Connect to PCB Ground plane.
7	NC	NC	No Connection.
8	$\overline{\text{POR}}$	Open Drain Output (1mA)	Open-drain POR Output for LDO-2 (active-low).
9	VO2	Analog I/O	LDO-2 Output: Connect capacitor of value 1 μ F to 10 μ F to GND (1 μ F recommended).
10	VO1	Analog I/O	LDO-1 Output: Connect capacitor of value 1 μ F to 10 μ F to GND (1 μ F recommended).

Typical Application

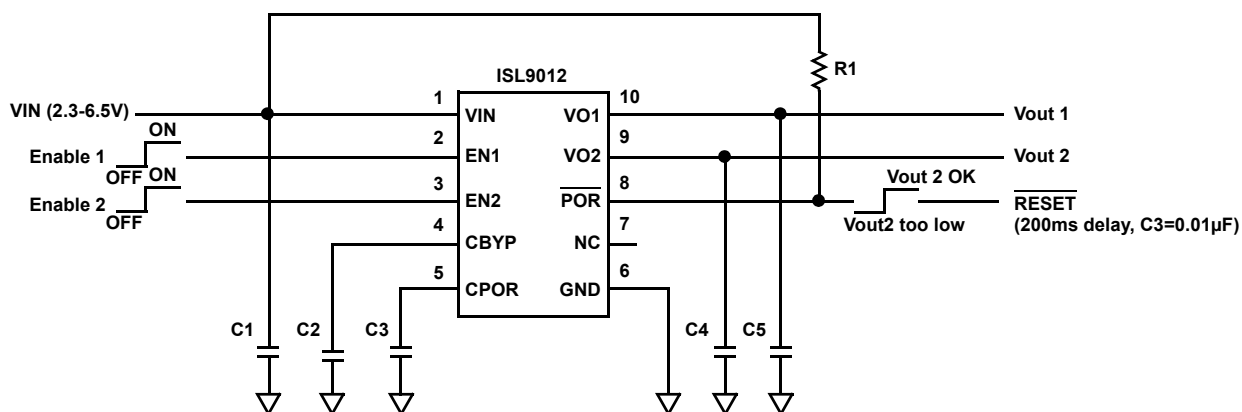

- C1, C4, C5: 1 μ F X5R ceramic capacitor
- C2: 0.01 μ F X5R ceramic capacitor
- C3: 0.01 μ F X5R ceramic capacitor
- R1: 100k Ω resistor, 5%

Block Diagram

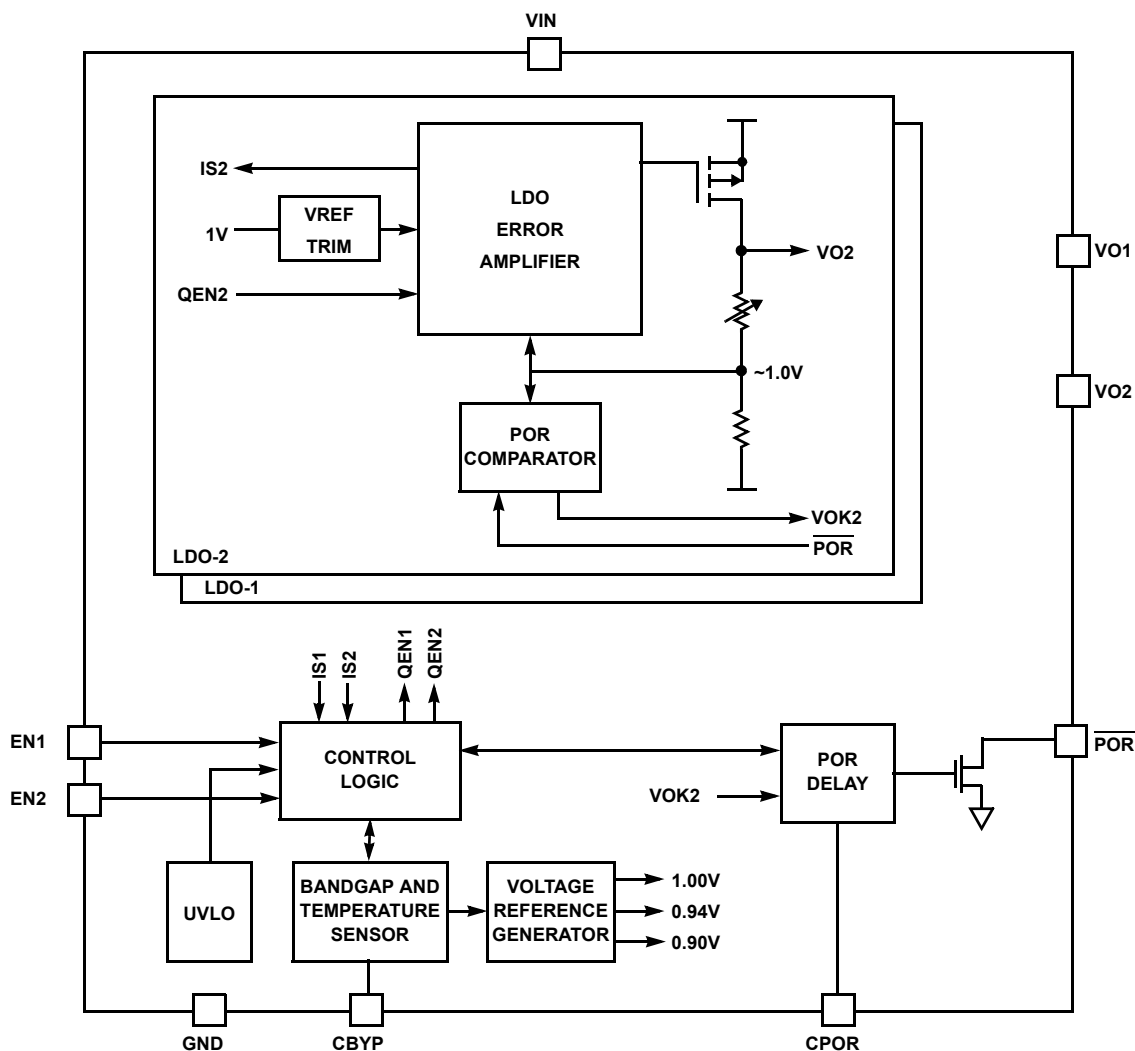

Functional Description

The ISL9012 contains all circuitry required to implement two high performance LDO's. High performance is achieved through a circuit that delivers fast transient response to varying load conditions. In a quiescent condition, the ISL9012 adjusts its biasing to achieve the lowest standby current consumption.

The device also integrates current limit protection, smart thermal shutdown protection, staged turn-on and soft-start. Smart Thermal shutdown protects the device against overheating. Staged turn-on and soft-start minimize start-up input current surges without causing excessive device turn-on time.

Power Control

The ISL9012 has two separate enable pins, EN1 and EN2, to individually control power to each of the LDO outputs. When both EN1 and EN2 are low, the device is in shutdown

mode. During this condition, all on-chip circuits are off, and the device draws minimum current, typically less than $0.1\mu\text{A}$. When one or both of the enable pins are asserted, the device first polls the output of the UVLO detector to ensure that VIN voltage is at least about 2.1V. Once verified, the device initiates a start-up sequence. During the start-up sequence, trim settings are first read and latched. Then, sequentially, the bandgap, reference voltage and current generation circuitry power up. Once the references are stable, a fast-start circuit quickly charges the external reference bypass capacitor (connected to the CBYP pin) to the proper operating voltage. After the bypass capacitor has been charged, the LDO's power up.

If EN1 is brought high, and EN2 is goes high before the VO1 output stabilizes, the ISL9012 delays the VO2 turn-on until the VO1 output reaches its target level. This minimizes input current surge due to concurrent turn-on.

If EN2 is brought high, and EN1 goes high before the VO2 output stabilizes, the ISL9012 delays the VO1 turn-on until the VO2 output reaches its target level.

If both EN1 and EN2 are high, the VO1 output has priority, and is always powered up first.

During operation, whenever the VIN voltage drops below about 1.8V, the ISL9012 immediately disables both LDO outputs. When VIN rises back above 2.1V, the device re-initiates its start-up sequence and LDO operation will resume automatically.

Reference Generation

The reference generation circuitry includes a trimmed bandgap, a trimmed voltage reference divider, a trimmed current reference generator, and an RC noise filter. The filter includes the external capacitor connected to the CBYP pin. A 0.01 μ F capacitor connected CBYP implements a 100Hz lowpass filter, and is recommended for most high performance applications. For the lowest noise application, a 0.1 μ F or greater CBYP capacitor should be used. This filters the reference noise to below the 10Hz – 1kHz frequency band, which is crucial in many noise-sensitive applications.

The bandgap generates a zero temperature coefficient (TC) voltage for the reference divider. The reference divider provides the regulation reference, POR detection thresholds, and other voltage references required for current generation and over-temperature detection.

The current generator outputs references required for adaptive biasing as well as references for LDO output current limit and thermal shutdown determination.

LDO Regulation and Programmable Output Divider

The LDO Regulator is implemented with a high-gain operational amplifier driving a PMOS pass transistor. The design of the ISL9012 provides a regulator that has low quiescent current, fast transient response, and overall stability across all operating and load current conditions. LDO stability is guaranteed for a 1 μ F to 10 μ F output capacitor that has a tolerance better than 20% and ESR less than 200m Ω . The design is performance-optimized for a 1 μ F capacitor. Unless limited by the application, use of an output capacitor value above 4.7 μ F is not recommended as LDO performance improvement is minimal.

Soft-start circuitry integrated into each LDO limits the initial ramp-up rate to about 30 μ s/V to minimize current surge. The ISL9012 provides short-circuit protection by limiting the output current to about 475mA.

Each LDO uses an independently trimmed 1V reference. An internal resistor divider drops the LDO output voltage down to 1V. This is compared to the 1V reference for regulation. The resistor division ratio is programmed in the factory to one of the following output voltages: 1.5V, 1.8V, 1.85, 2.5V, 2.6, 2.7, 2.8V, 2.85V, 2.9, 3.0, and 3.3V.

Power On Reset Generation

LDO-2 has a Power-on Reset signal generation circuit which outputs to the POR pin. The POR signal is generated as follows:

A POR comparator continuously monitors the voltage of the LDO-2 output. The LDO enters a power-good state when the output voltage is above 94% of the expected output voltage for a period exceeding the LDO PGOOD entry delay time. In the power-good state, the open-drain POR output is in a high-impedance state. An external resistor can be added between the POR output and either LDO output or the input voltage, VIN.

The power-good state is exited when the LDO-2 output falls below 90% of the expected output voltage for a period longer than the PGOOD exit delay time. While power-good is false, the ISL9012 pulls the respective POR pin low.

The PGOOD entry and exit delays are determined by the value of the external capacitor connected to the CPOR pin. For a 0.01 μ F capacitor, the entry and exit delays are 200ms and 25 μ s respectively. Larger or smaller capacitor values will yield proportionately longer or shorter delay times. The POR exit delay should never be allowed to be less than 10 μ s to ensure sufficient immunity against transient induced false POR triggering.

Overheat Detection

The bandgap outputs a proportional-to-temperature current that is indicative of the temperature of the silicon. This current is compared with references to determine if the device is in danger of damage due to overheating. When the die temperature reaches about 145°C, one or both of the LDO's momentarily shut down until the die cools sufficiently. In the overheat condition, only the LDO sourcing more than 50mA will be shut off. This does not affect the operation of the other LDO. If both LDOs source more than 50mA and an overheat condition occurs, both LDO outputs are disabled. Once the die temperature falls back below about 110°C, the disabled LDO(s) are re-enabled and soft-start automatically takes place.

Dual Flat No-Lead Plastic Package (DFN)

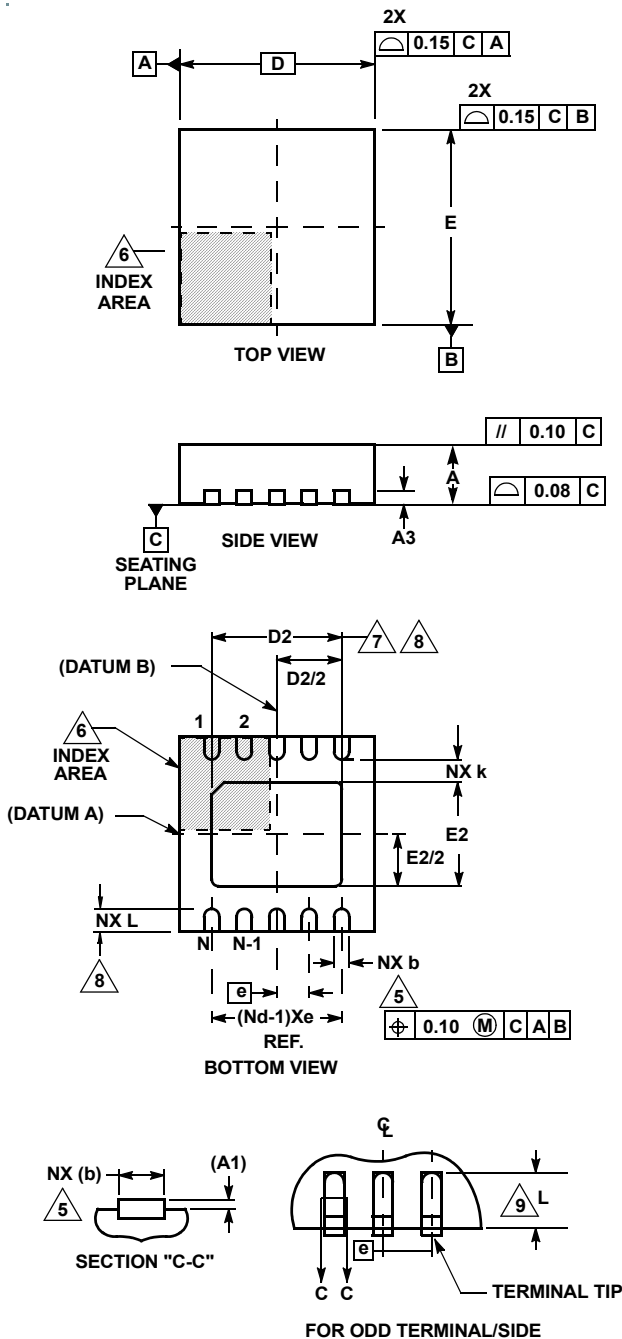

L10.3x3C

10 LEAD DUAL FLAT NO-LEAD PLASTIC PACKAGE

SYMBOL	MILLIMETERS			NOTES
	MIN	NOMINAL	MAX	
A	0.80	0.90	1.00	-
A1	-	-	0.05	-
A3	0.20 REF			-
b	0.18	0.25	0.30	5, 8
D	3.00 BSC			-
D2	2.23	2.38	2.48	7, 8
E	3.00 BSC			-
E2	1.49	1.64	1.74	7, 8
e	0.50 BSC			-
k	0.20	-	-	-
L	0.30	0.40	0.50	8
N	10			2
Nd	5			3

Rev. 0 3/05

NOTES:

1. Dimensioning and tolerancing conform to ASME Y14.5-1994.
2. N is the number of terminals.
3. Nd refers to the number of terminals on D.
4. All dimensions are in millimeters. Angles are in degrees.
5. Dimension b applies to the metallized terminal and is measured between 0.15mm and 0.30mm from the terminal tip.
6. The configuration of the pin #1 identifier is optional, but must be located within the zone indicated. The pin #1 identifier may be either a mold or mark feature.
7. Dimensions D2 and E2 are for the exposed pads which provide improved electrical and thermal performance.
8. Nominal dimensions are provided to assist with PCB Land Pattern Design efforts, see Intersil Technical Brief TB389.
9. COMPLIANT TO JEDEC MO-229-WEED-3 except for dimensions E2 & D2.

All Intersil U.S. products are manufactured, assembled and tested utilizing ISO9000 quality systems. Intersil Corporation's quality certifications can be viewed at www.intersil.com/design/quality

Intersil products are sold by description only. Intersil Corporation reserves the right to make changes in circuit design, software and/or specifications at any time without notice. Accordingly, the reader is cautioned to verify that data sheets are current before placing orders. Information furnished by Intersil is believed to be accurate and reliable. However, no responsibility is assumed by Intersil or its subsidiaries for its use; nor for any infringements of patents or other rights of third parties which may result from its use. No license is granted by implication or otherwise under any patent or patent rights of Intersil or its subsidiaries.

For information regarding Intersil Corporation and its products, see www.intersil.com