



EVERYTHING

IN A

NEW

LIGHT.

Description

PerkinElmer Type C30902E avalanche photodiode utilizes a silicon detector chip fabricated with a double-diffused "reach-through" structure. This structure provides high responsivity between 400 and 1000 nm as well as extremely fast rise and fall times at all wavelengths. Because the fall time characteristics have no "tail", the responsivity of the device is independent of modulation frequency up to about 800 MHz. The detector chip is hermetically-sealed behind a flat glass window in a modified TO-18 package. The useful diameter of the photosensitive surface is 0.5 mm.

PerkinElmer Type C30921E utilizes the same silicon detector chip as the C30902E, but in a package containing a lightpipe which allows efficient coupling of light to the detector from either a focussed spot or an optical fiber up to 0.25 mm in diameter. The internal end of the lightpipe is close enough to the detector surface to allow all of the illumination exiting the lightpipe to fall within the active-area of the detector. The hermetically-sealed TO-18 package allows fibers to be epoxied to the end of the lightpipe to minimize signal losses without fear of endangering detector stability.

The C30902E and C309021E are designed for a wide variety of uses including optical communications at data rates to 1 GBit/second, laser range-finding, and any other applications requiring high speed and/or high responsivity.

Silicon Avalanche Photodiodes C30902E, C30902S, C30921E, C30921S

High Speed Solid State Detectors for Fiber Optic and Very Low Light-Level Applications



Features

- High Quantum Efficiency 77% Typical at 830 nm
- C30902S and C30921S in Geiger Mode:
 - Single-Photon Detection Probability to 50%
 - Low Dark-Count Rate at 5% Detection Probability - Typically 15,000/second at +22°C
 - 350/second at -25°C
 - Count Rates to 2×10^6 /second
- Hermetically Sealed Package
- Low Noise at Room Temperature
 - C30902E, C30921E - 2.3×10^{-13} A/Hz^{1/2}
 - C30902S, C30921S - 1.1×10^{-13} A/Hz^{1/2}
- High Responsivity - Internal Avalanche Gains in Excess of 150
- Spectral Response Range - (10% Points) 400 to 1000 nm
- Time Response - Typically 0.5 ns
- Wide Operating Temperature Range - -40°C to +70°C

The C30902S and C30921S are selected C30902E and C30921E photodiodes having extremely low noise and bulk dark-current. They are intended for ultra-low light level applications (optical power less than 1 pW) and can be used in either their normal linear mode ($V_R < V_{BR}$) at gains up to 250 or greater, or as photon counters in the "Geiger" mode ($V_R > V_{BR}$) where a single photoelectron may trigger an avalanche pulse of about 10^8 carriers. In this mode, no amplifiers are necessary and single-photon detection probabilities of up to approximately 50% are possible.

Photon-counting is also advantageous where gating and coincidence techniques are employed for signal retrieval.

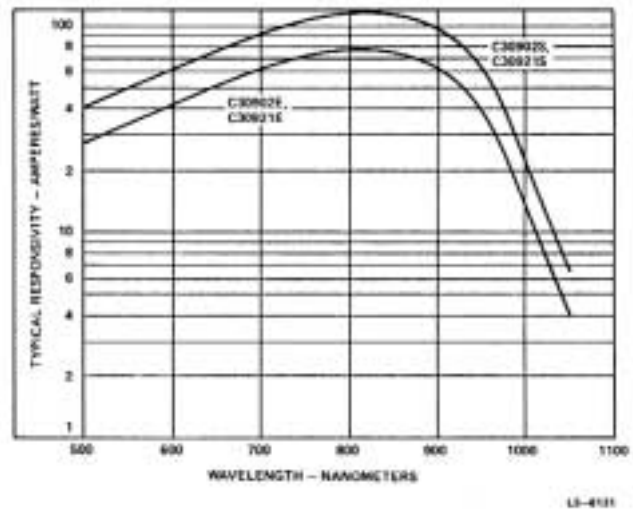

Figure 1. Typical Spectral Responsivity at 22°C

Optical Characteristics

C30902E, C30902S (Figure 13)

Photosensitive Surface:

- ShapeCircular
- Useful area0.2 mm²
- Useful diameter0.5 mm

Field of View:

- Approximate full angle for totally illuminated photosensitive surface100 deg

C30921E, C30921S (Figure 14)

- Numerical Aperture of Light Pipe0.55
- Refractive Index (n) of Core1.61
- Lightpipe Core Diameter0.25 mm

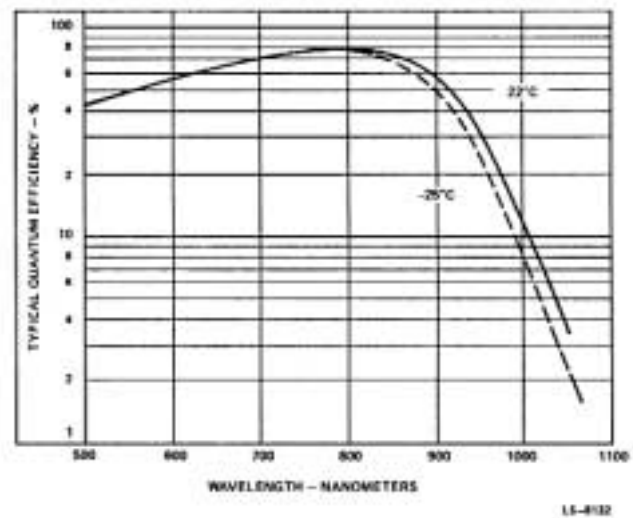

Figure 2. Typical Quantum Efficiency vs. Wavelength

Maximum Ratings, Absolute-Maximum Values (All Types)

Reverse Current at 22°C:

- Average value, continuous operation 200 μA
- Peak value (for 1 second duration, non-repetitive) 1 mA

Forward Current, I_F at 22°C:

- Average value, continuous operation 5 mA
- Peak value (for 1 second duration, non-repetitive) 50 mA

Maximum Total Power Dissipation at 22°C 60 mW

Ambient Temperature:

- Storage, T_{stg} -60 to +100°C
- Operating, T_A -40 to +70°C
- Soldering (for 5 seconds) 200°C

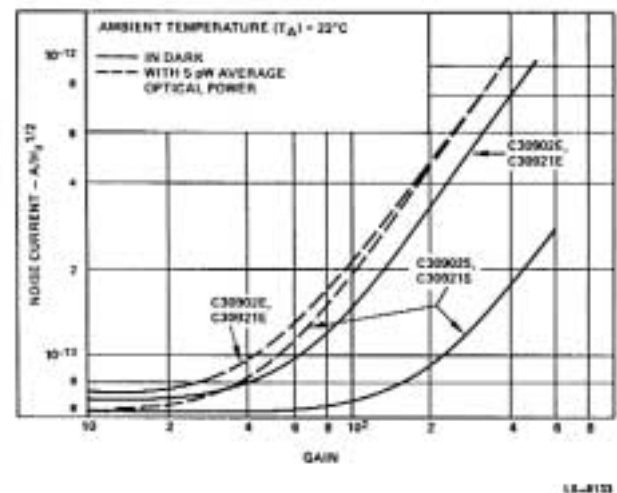

Figure 3. Typical Noise Current vs. Gain

Electrical Characteristics¹ at T_A = 22°C

	C30902E, C309021E			C30902S, C30921S			Units
	Min	Typ	Max	Min	Typ	Max	
Breakdown voltage, V_{BR}	-	225	-	-	225	-	V
Temperature Coefficient of V_R for Constant Gain	0.5	0.7	0.8	0.5	0.7	0.8	V/°C
Gain	-	150	-	-	250	-	
Responsivity:							
At 900 nm	55	65	-	92	108	-	A/W
At 830 nm	70	77	-	117	128	-	A/W
Quantum Efficiency:							
At 900 nm	-	60	-	-	60	-	%
At 830 nm	-	77	-	-	77	-	%
Dark Current, I_d	-	1.5x10 ⁻⁸	3x10 ⁻⁸	-	1x10 ⁻⁸	3x10 ⁻⁸	A
		(Figure 6)		(Figure 6)			
Noise Current, i_n:²							
f = 10 kHz, Δf = 1.0 Hz	-	2.3x10 ⁻¹³	5x10 ⁻¹³	-	1.1x10 ⁻¹³	2x10 ⁻¹³	A/Hz ^{1/2}
		(Figure 3)		(Figure 3)			
Capacitance, C_d	-	1.6	2	-	1.6	2	pF
Rise Time, t_r:							
R _L = 50Ω, λ = 830 nm, 10% to 90% points	-	0.5	0.75	-	0.5	0.75	ns
Fall Time:							
R _L = 50Ω, λ = 830 nm, 90% to 10% points	-	0.5	0.75	-	0.5	0.75	ns
Geiger Mode (See Appendix)							
Dark Count Rate at 5% Photon Detection Probability ³ (830 nm):							
22°C	-	-	-	-	15,000	30,000	cps
-25°C	-	-	-	-	350	700	cps
Voltage Above V _{BR} for 5% Photon Detection Probability ³ (830 nm) (See Figure 8)	-	-	-	-	2	-	V
Dead-Time Per Event (See Appendix)	-	-	-	-	300	-	ns
After-Pulse Ratio at 5% Photon Detection Probability (830 nm) 22°C ⁴	-	-	-	-	2	15	%

Note 1. At the DC reverse operating voltage V_R supplied with the device and a light spot diameter of 0.25 mm (C30902E, S) or 0.10 mm (C30921E, S). Note that a specific value of V_R is supplied with each device. When the photodiode is operated at this voltage, the device will meet the electrical characteristic limits shown above. The voltage value will be within the range of 180 to 250 volts.

Note 2. The theoretical expression for shot noise current in an avalanche photodiode is $i_n = (2q(I_{ds} + I_{db}M^2 + P_oRM)F)B_w)^{1/2}$ where q is the electronic charge, I_{ds} is the dark surface current, I_{db} is the dark bulk current, F is the excess noise factor, M is the gain, P_o is the optical power on the device, and B_w is the noise bandwidth. For these devices F = 0.98 (2-1/M) + 0.02 M. (Reference: PP Webb, RJ McIntyre, JJ Conradi, "RCA Review", Vol. 35 p. 234, (1974)).

Note 3. The C30902S and C30921S can be operated at a substantially higher Detection Probabilities. See Appendix.

Note 4. After-Pulse occurring 1 microsecond to 60 seconds after main pulse.

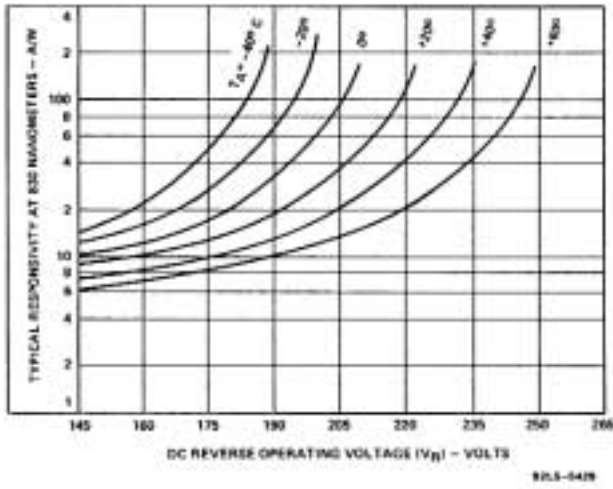

Figure 4. Typical Responsivity at 830 nm vs. Operating Voltage

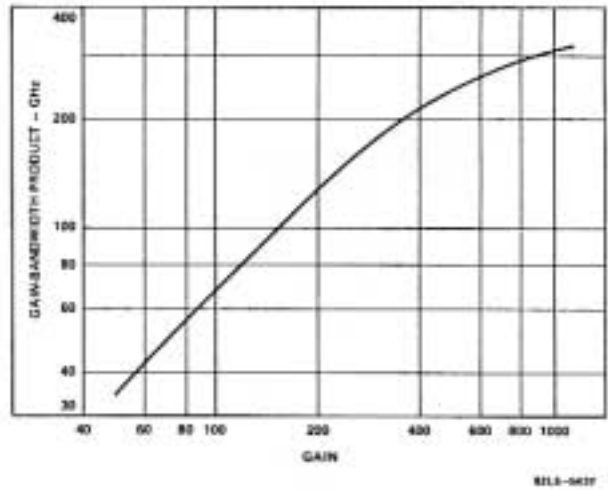

Figure 5. Typical Gain-Bandwidth Product vs. Gain

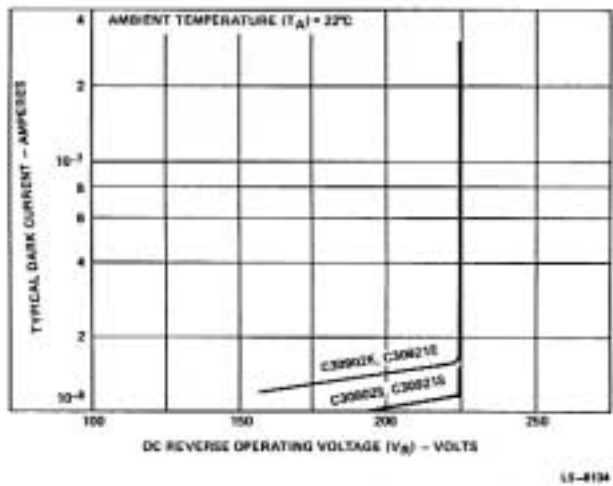

Figure 6. Typical Dark Current vs. Operating Voltage ($V < V_{BR}$)

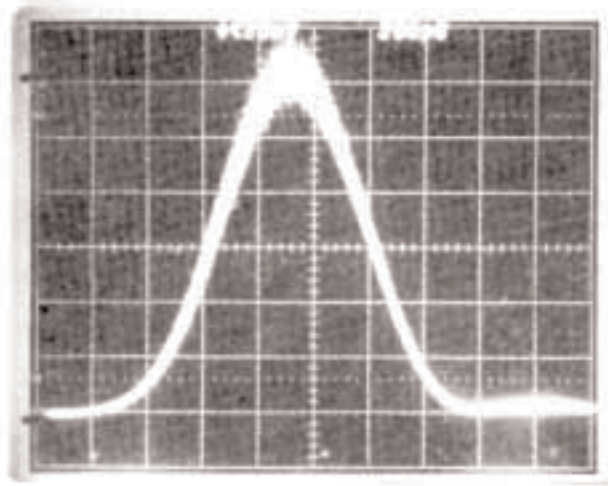

Figure 7. Avalanche Photodiode Response to a 100 ps Laser Pulse as Measured with a 350 ps Sampling Head. (Horizontal Axis: 200 ps/Division)

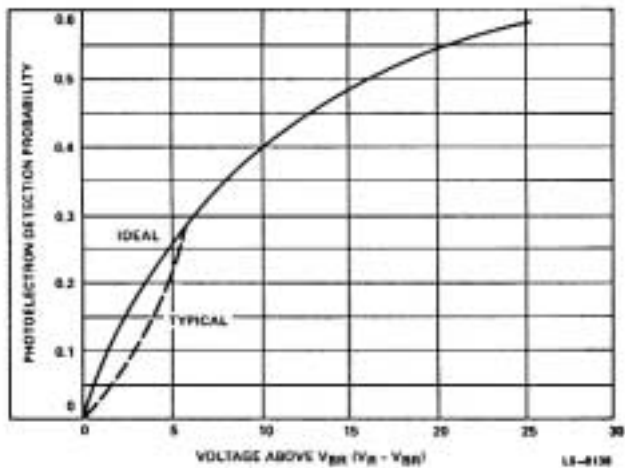

Figure 8. Geiger Mode, Photoelectron Detection Probability vs. Voltage Above V_{BR} ($V_R > V_{BR}$)

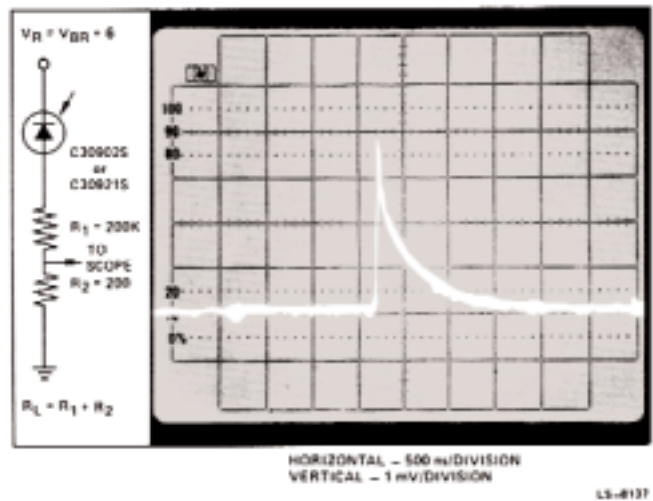

Figure 9. Passively Quenched Circuit and Resulting Pulse Shape

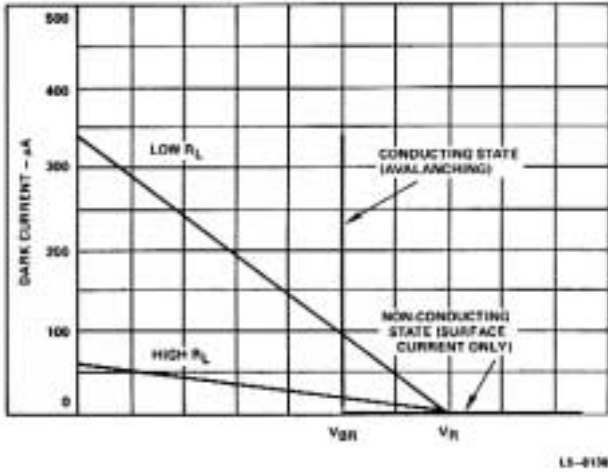

Figure 10. Load Line for C30921S in the Geiger Mode

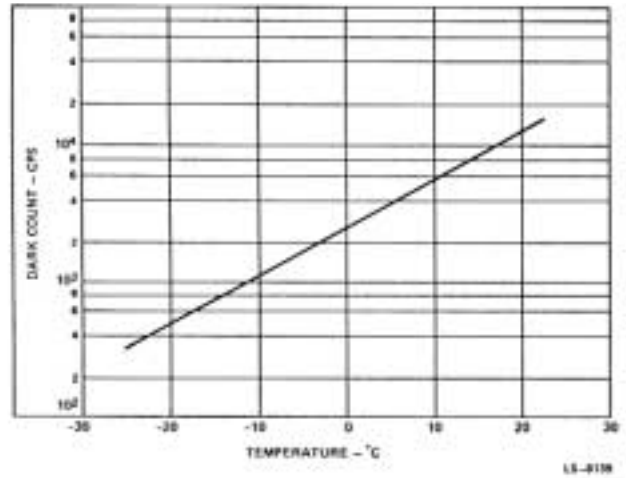

Figure 11. Typical Dark Count vs. Temperature at 5% Photon (830 nm) Detection Efficiency

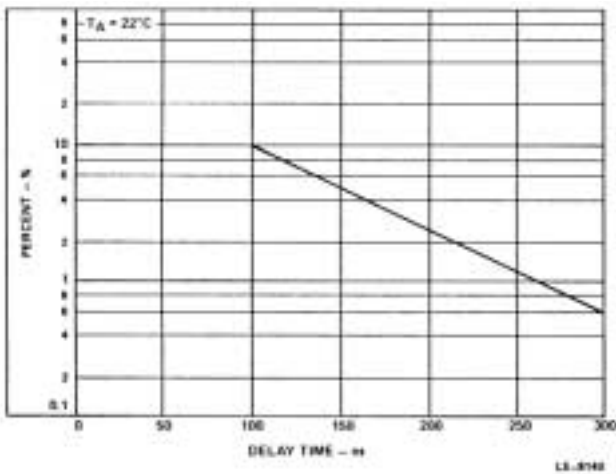
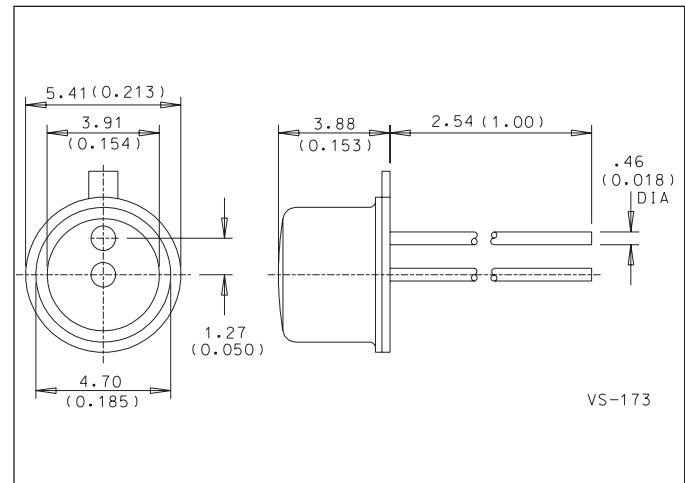

Figure 12. Chance of an After-Pulse within the Next 100 ns vs. Delay-Time in an Actively Quenched Circuit. (Typical for C30902S, C30921S at $V_{BR} + 25$)



Modified TO-18 Package.

Note: Optical distance is defined as the distance from the surface of the silicon chip to the front surface of the window.

Figure 13. Dimensional Outline - C30902E, C30902S, C30921E, C30921S

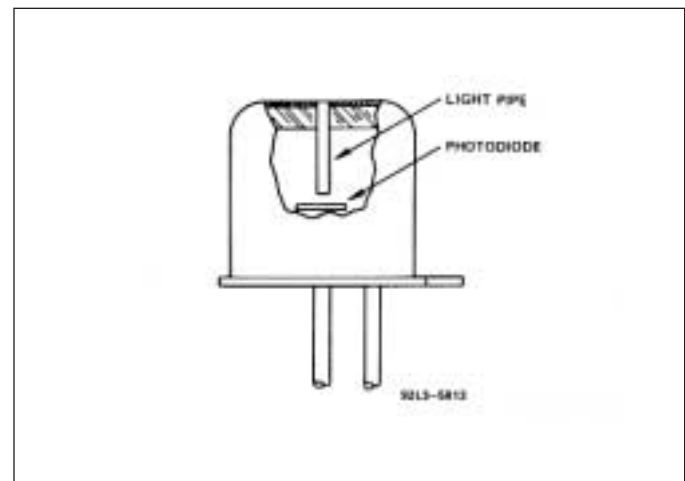

Figure 14. Cutaway of the C30921E, C30921S

Operation of the C30902S and C30921S in the Geiger Mode

Introduction

When biased above the breakdown voltage, an avalanche photodiode will normally conduct a large current. However, if the current is such that the current is limited to less than a particular value (about $50 \mu\text{A}$ for these diodes), the current is unstable and can switch off by itself. The explanation of this behavior is that the number of carriers in the avalanche region at any one time is small and fluctuating wildly. If the number happens to fluctuate to zero, the current must stop. It subsequently remains off until the avalanche pulse is retriggered by a bulk- or photo-generated carrier.

The C30902S and C30921S are selected to have small bulk-generated dark-current. This makes them suitable for low-noise operation below V_{BR} or of photon-counting above V_{BR} in the Geiger mode. In this so-called Geiger mode, a single photoelectron (or thermally-generated electron) may trigger an avalanche pulse which discharges the photodiode from its reverse voltage V_R to a voltage slightly below V_{BR} . The probability of this avalanche occurring is shown in Figure 8 as the "Photoelectron Detection Probability" and as can be seen, it increases with reverse voltage V_R . For a given value of $V_R - V_{BR}$, the Photoelectron Detection Probability is independent of temperature. To determine the Photon Detection Probability, it is necessary to multiply the Photoelectron Detection Probability by the Quantum Efficiency, which is shown in Figure 2, the Quantum Efficiency also is relatively independent of temperature, except near the 100 nm cutoff.

The C30902S and C30921S can be used in the Geiger mode using either "passive" or "active" pulse quenching circuits. The advantages and disadvantages of each are discussed below.

Passive-Quenching Circuit

The simplest, and in many cases a perfectly adequate method of quenching a breakdown pulse, is through the use of a current limiting load resistor. An example of such a "passive" quenching circuit is shown in Figure 9. The load-line of the circuit is shown in Figure 10. To be in the conducting state at V_{BR} two conditions must be met:

1. The avalanche must have been triggered by either a photoelectron or a bulk-generated electron entering the avalanche region of the diode. (Note: holes are inefficient at starting avalanches in silicon.) The probability of an avalanche being initiated is discussed above.
2. To continue to be in the conducting state a sufficiently large current, called the latching current I_{LATCH} , must be passing through the device so that there is always an electron or hole in the avalanche region. Typically in the C30902S and C30921S, $I_{LATCH} = 50 \mu\text{A}$. For currents $(V_B - V_{BR})/R_L$, much greater than I_{LATCH} , the diode remains conducting. If the current $(V_R - V_{BR})/R_L$, is much less than I_{LATCH} , the diode switches almost immediately to the non-conducting state. If $(V_B - V_{BR})/R_L$, is approximately equal to I_{LATCH} , then the diode will switch at an arbitrary time from the conducting to the non-conducting state depending on when the number of electrons and holes in the avalanche region statistically fluctuates to zero.

When R_L is large, the photodiode is normally nonconducting, and the operating point is at $V_R - I_{DS}R_L$ in the non-conducting state. Following an avalanche breakdown, the device recharges to the voltage $V_R - I_{DS}R_L$ with the time constant CR_L where C is the total device capacitance including stray capacitance. Using $C = 1.6 \text{ pF}$ and $R_L = 200.2 \text{ K}\Omega$ a recharge time constant of 0.32 microseconds is calculated, in reasonable agreement with observation as shown in Figure 9. As is also evident from Figure 9, the rise-time is fast, 5 to 50 ns, decreases as $V_R - V_{BR}$ increases, and is very dependent on the capacitances of the load resistors, leads, etc. The jitter at the half-voltage point is typically the same order of magnitude as the rise-time. For timing purposes where it is important to have minimum jitter, the lowest possible threshold of the rising pulse should be used.

Active-Quenching Circuit

Until the C30902S or C30921S is recharged, the probability of detecting another incoming photoelectron is relatively low. To avoid an excessive dead-time when operating at a large voltage above V_{BR} , an "actively quenched" circuit can be used. The circuit temporarily drops the bias voltage for a fraction of a microsecond following the detection of an avalanche discharge. This delay time allows all electrons and holes to be collected, including most of those temporarily "trapped" at various impurity sites in the silicon. When the higher voltage is reapplied, there are not electrons in the depletion region to trigger another avalanche or latch the diode. Recharging can now be very rapid through a small load resistor. Alternatively, the bias voltage can be maintained but the load resistor is replaced by a transistor which is kept off for a short time after an avalanche, and then turned on for a period sufficient to recharge the photodiode.

After-Pulsing

An after-pulse is an avalanche breakdown pulse which follows a photon-generated pulse and is induced by it. An after-pulse is usually caused by one of the approximately 10^8 carriers which pass through the diode because of the first avalanche. This electron or hole is captured and trapped at some impurity site in the silicon, as previously described. When this charge-carrier is liberated, usually in less than 100 ns but sometimes several milliseconds later, it may start another avalanche. The probability of an after-pulse occurring more than one microsecond later is typically less than 2% at 2 volts above V_{BR} , using the circuit shown in Figure 9. After-pulsing increases with bias voltage. If it is necessary to reduce after-pulses, it is recommended that one keep $V_R - V_{BR}$ low, use an actively-quenched circuit with a long delay-time (See Figure 12), or a passively-quenched circuit with a long $R_L C$ constant. Stray capacitances must also be minimized. Electronic gating of the signal can be performed in certain situations. Should after-pulses be a serious complication in a particular application, operation below V_{BR} with a good amplifier might be considered.

Dark Current

Both the C30902S and C30921S have been selected to have a low dark-count rate. Cooling to -25°C can reduce this by a factor of 50, since the dependence of dark-count rate on temperature is exponential.

The dark-count increases with voltage following the same curve as the Photoelectron Detection Probability until a voltage where after-pulsing is responsible for a feedback mechanism which dramatically increases the dark-count rate. This maximum voltage is circuit dependent, and is not warranted other than the values listed on page 3. In most cases, with a delay time of 300 ns, the diode can be used effectively at V_R up to $V_{BR} + 25\text{V}$.

The C30902S and C30921S should not be forward biased or, when unbiased, exposed to strong illumination. These conditions result in a greatly enhanced dark-count which requires up to 24 hours to return to its nominal value.