

7294621 POWEREX INC

02E 02910 D T-25-19

POWEREX INC

02 DE 7294621 0002910 4



C350

Powerex, Inc. Hillis Street, Youngwood, Pennsylvania 15697 (412) 925-7272
 Powerex Europe, S.A., 428 Ave. G. Durand, BP107, 72003 LeMans, France (43) 72.75.15

Phase Control SCR
115 Amperes Avg
500-1300 Volts

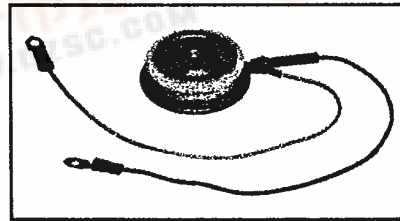
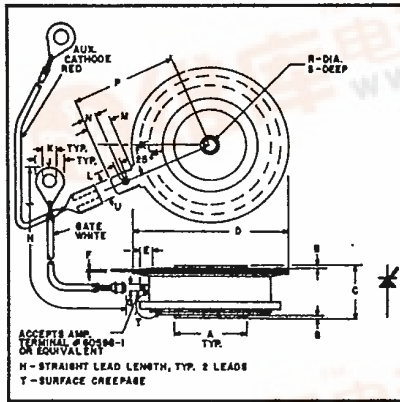

C350
Phase Control SCR
 115 Amperes/500-1300 Volts

Description

Powerex Silicon Controlled Rectifiers (SCR) are designed for phase control applications. These are all-diffused, Press-Pak (Pow-R-Disc) devices employing the field-proven amplifying (di/namic) gate.

Features:

- Low On-State Voltage
- High di/dt
- High dv/dt
- Hermetic Packaging
- Excellent Surge and I²t Ratings

Applications:

- Power Supplies
- Battery Chargers
- Motor Control
- Light Dimmers
- VAR Generators

Ordering Information

Example: Select the complete five or six digit part number you desire from the table - i.e. C350M is a 600 Volt, 115 Ampere Phase Control SCR.

TO-200
Outline Drawing

Dimensions	Inches		Millimeters	
	Min.	Max.	Min.	Max.
A	.744	.752	18.897	19.101
B	.030	.060	.762	1.524
C	.515	.565	13.081	14.351
D	1.600	1.656	40.64	42.06
E	.110	—	2.794	—
F	.013	.017	.330	.432
G	.057	.059	1.447	1.449
H	7.980	8.115	202.70	206.11
J	—	.300	—	7.620
K	.137	.153	3.479	3.886
L	.065	.070	1.651	1.778
M	.245	.260	6.223	6.604
N	.120	.140	3.048	3.556
P	1.090	1.125	27.69	28.55
R	.135	.145	3.429	3.683
S	.067	.083	1.701	2.108
T	.340	—	8.636	—
U	.186	.189	4.724	4.801

Type	Voltage		Current
	V _{ORM} V _{RRM}	Code	
C350	500	E	115
	600	M	
	700	S	
	800	N	
	900	T	
	1000	P	
	1100	PA	
	1200	PB	
	1300	PC	





Powerex, Inc., Hillis Street, Youngwood, Pennsylvania 15697 (412) 925-7272
 Powerex Europe, S.A., 428 Ave. G. Durand, BP107, 72003 LeMans, France (43) 72.75.15

C350
Phase Control SCR
 115 Amperes Avg/500-1300 Volts

Absolute Maximum Ratings

	Symbol	C350	Units
RMS On-State Current			
Average On-State Current	$I_{T(RMS)}$	180	Amperes
Peak One-Cycle Surge (Non-Repetitive) On-State Current (60Hz)	$I_{T(av)}$	115	Amperes
Peak One-Cycle Surge (Non-Repetitive) On-State Current (50Hz)	I_{TSM}	1600	Amperes
Critical Rate-of-Rise of On-State Current (Non-Repetitive)	I_{TSM}	1480	Amperes
Critical Rate-of-Rise of On-State Current (Repetitive)	di/dt	800	Amperes/ μ s
I^2t (for Fusing), 8.3 milliseconds	di/dt	500	Amperes/ μ s
Peak Gate Power Dissipation	I^2t	10,600	A ² sec
Average Gate Power Dissipation	P_{GM}	10	Watts
Storage Temperature	$P_{G(av)}$	2	Watts
Operating Temperature	T_{STG}	-40 to 150	°C
Mounting Force [Ⓞ]	T_J	-40 to 125	°C
Mounting Force [Ⓞ]		720 to 880	lb.
		3.20 to 3.92	kN

[Ⓞ] Consult recommended mounting procedures.



Powerex, Inc., Hillis Street, Youngwood, Pennsylvania 15697 (412) 925-7272

Powerex Europe, S.A., 428 Ave. G. Durand, BP107, 72003 LeMans, France (43) 72.75.15

C350

Phase Control SCR

115 Amperes Avg/500-1300 Volts

Electrical and Thermal Characteristics

Characteristics	Symbol	Test Conditions	C350	Units
Voltage—Blocking State Maximums				
Forward Leakage, Peak	I_{DRM}	$T_J = 125^\circ\text{C}, V = V_{DRM}$	20	mA
Reverse Leakage, Peak	I_{RRM}	$T_J = 125^\circ\text{C}, V = V_{RRM}$	20	mA
Current—Conducting State Maximums				
Peak On-State Voltage	V_{TM}	$I_{TM} = 500\text{A Peak}, T_C = 25^\circ\text{C}, \text{Duty Cycle} \leq 0.01\%$	2.6	Volts
Switching				
Typical Turn-Off Time	t_q	$T_J = 125^\circ\text{C}; I_{TM} = 50\text{ Amps Peak};$ $V_R = 50\text{ Volts Min.}; V_{DRM} = \text{Rated (Reapplied)};$ Rate-of-Rise of Reapplied Off-State Voltage = $20\text{V}/\mu\text{sec}$ (Linear); Gate Bias = 0 Volts, 100Ω during Turn-Off Interval; Duty Cycle $\leq 0.01\%$	200	μsec
Typical Delay Time	t_d	$T_C = 25^\circ\text{C}, I_{TM} = 50\text{ Adc}, V_{DRM} = \text{Rated},$ Gate Supply: 10 Volt Open Circuit, 20 Ohm, 0.1 μsec max. rise time	1.0	μsec
Min. Critical dv/dt exponential to V_{DRM}	dv/dt	$T_J = 125^\circ\text{C}, \text{Gate Open}$	200	V/ μsec
Thermal				
Maximum Thermal Resistance [ⓐ] , double sided cooling				
Junction to Case	$R_{\theta JC}$.135	$^\circ\text{C}/\text{Watt}$
Case to Sink, Lubricated	$R_{\theta CS}$.04	$^\circ\text{C}/\text{Watt}$
Gate—Maximum Parameters				
Gate Current to Trigger	I_{GT}	$V_D = 6\text{V}, T_C = 25^\circ\text{C}, R_L = 3\Omega$	150	mA
Gate Voltage to Trigger	V_{GT}	$V_D = 6\text{V}, R_L = 3\Omega, T_J = -40^\circ\text{C to } +120^\circ\text{C}$	3.0	Volts
Non-Triggering Gate Voltage	V_{GDM}	$T_C = 120^\circ\text{C}, \text{Rated } V_{DRM}, R_L = 1000\Omega$.15	Volts
Peak Forward Gate Current	I_{GTM}		10	Amperes
Peak Reverse Gate Voltage	V_{GRM}		5	Volts

[ⓐ] Consult recommended mounting procedures.



Powerex, Inc., Hillis Street, Youngwood, Pennsylvania 15697 (412) 925-7272
 Powerex Europe, S.A., 428 Ave. G. Durand, BP107, 72003 LeMans, France (43) 72.75.15

C350
 Phase Control SCR
 115 Amperes Avg/500-1300 Volts

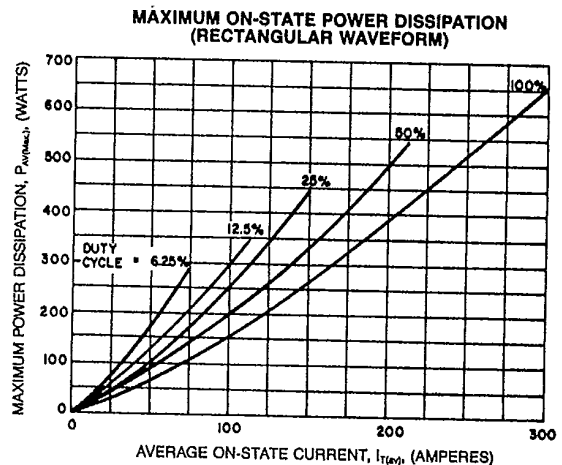
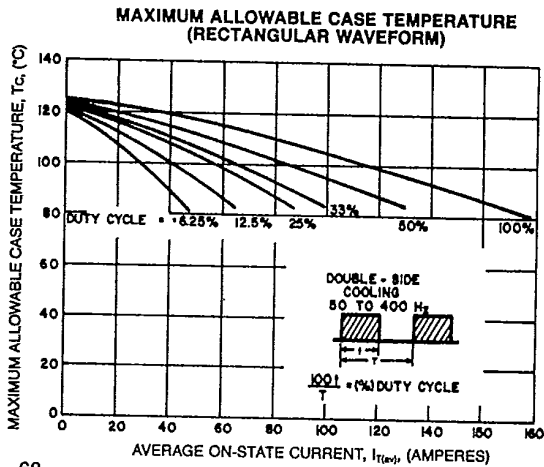
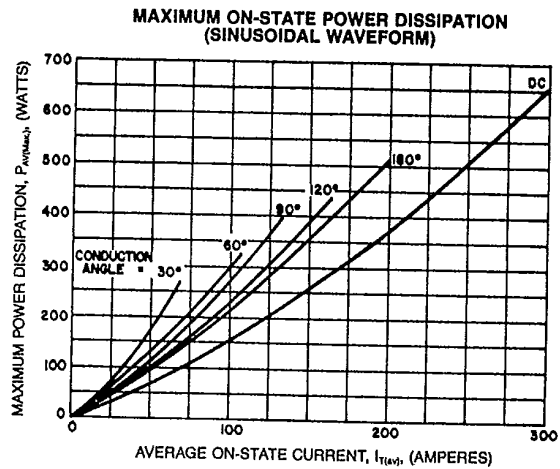
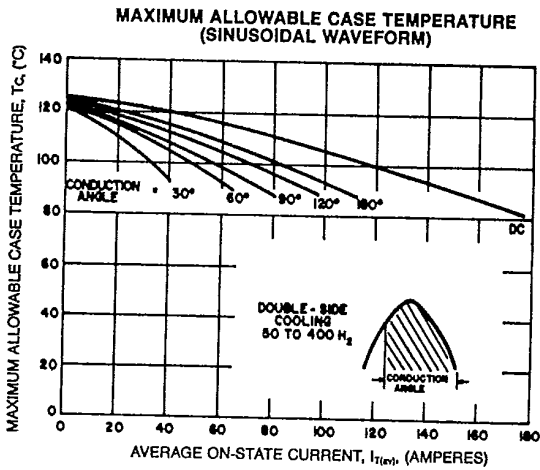
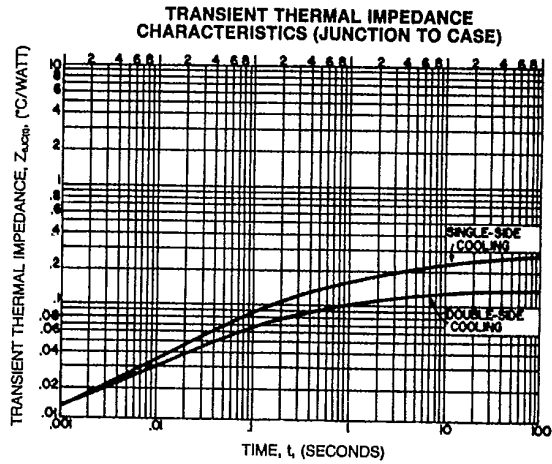
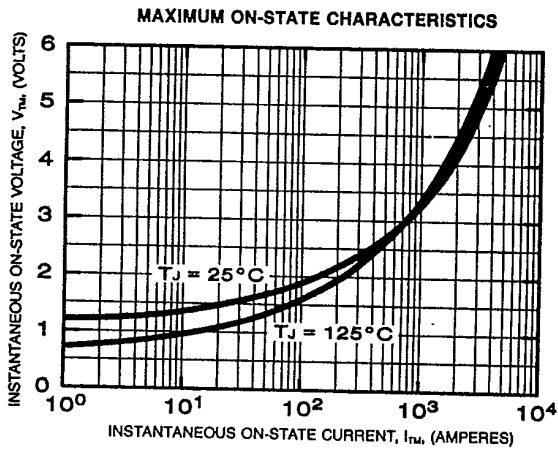



Powerex, Inc., Hillis Street, Youngwood, Pennsylvania 15697 (412) 925-7272
 Powerex Europe, S.A., 428 Ave. G. Durand, BP107, 72003 LeMans, France (43) 72.75.15

C350
 Phase Control SCR
 115 Amperes Avg/500-1300 Volts

MAXIMUM ALLOWABLE CASE TEMPERATURE
 (SINUSOIDAL WAVEFORM)

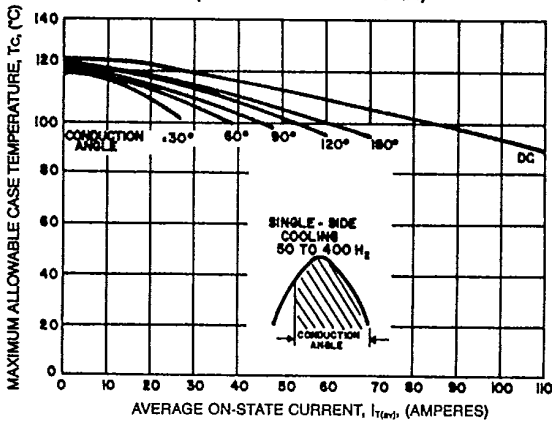

MAXIMUM ALLOWABLE CASE TEMPERATURE
 (RECTANGULAR WAVEFORM)

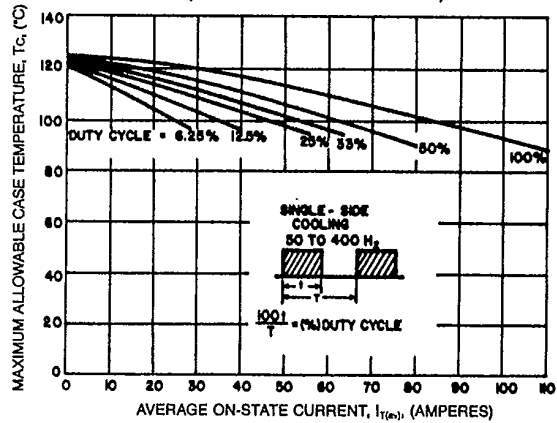

MAXIMUM ON-STATE POWER DISSIPATION
 (SINUSOIDAL WAVEFORM EXTENDED)

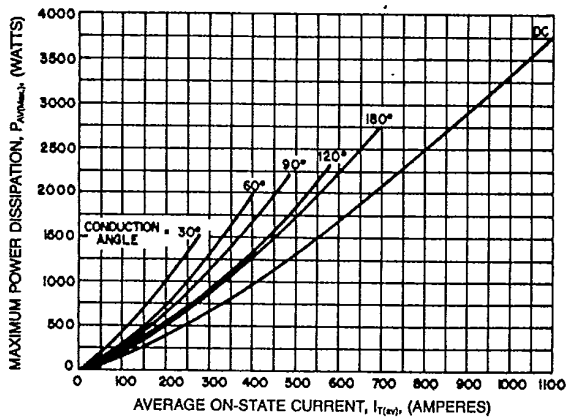



Powerex, Inc., Hillis Street, Youngwood, Pennsylvania 15697 (412) 925-7272
 Powerex Europe, S.A., 428 Ave. G. Durand, BP107, 72003 LeMans, France (43) 72.75.15

C350
 Phase Control SCR
 115 Amperes Avg/500-1300 Volts

SUB-CYCLE SURGE AND I²t RATINGS
 (RATED LOAD CONDITIONS)

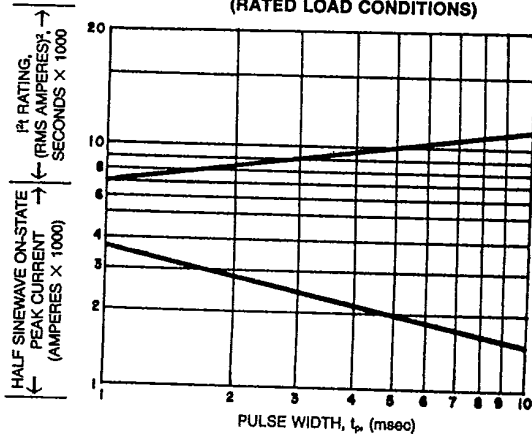

MAXIMUM ALLOWABLE SURGE ON-STATE CURRENT (NON-REPETITIVE)

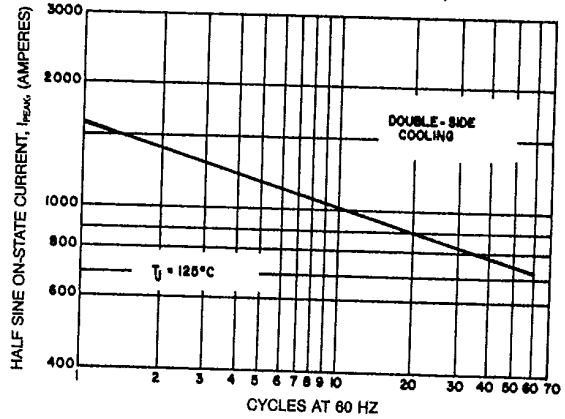

GATE CHARACTERISTICS

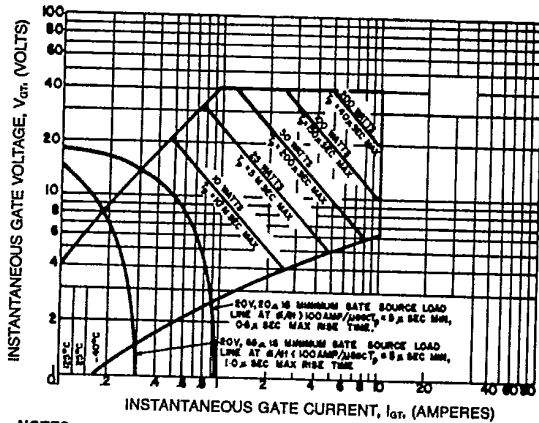

NOTES:

1. Maximum allowable gate power dissipation = 2 watts.
2. The locus of possible DC trigger points lie outside the boundaries shown at various case temperatures.
3. T_p = Rectangular Gate Current Pulse Width.