

C430

Powerex, Inc. Hillis Street, Youngwood, Pennsylvania 15697 (412) 925-7272
 Powerex Europe, S.A., 428 Ave. G. Durand, BP107, 72003 LeMans, France (43) 72.75.15

Phase Control SCR
680 Amperes Avg
500-1300 Volts

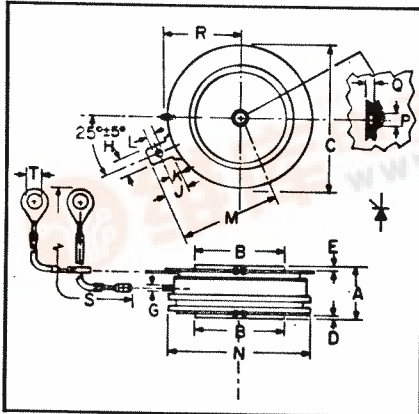

C430
Outline Drawing

Dimensions	Inches		Millimeters	
	Min.	Max.	Min.	Max.
A	.560	.605	14.22	15.37
B	.985	.995	25.01	25.27
C	1.600	1.650	40.64	41.91
D	.030	—	.76	—
E	.040	—	1.01	—
G	.057	.059	1.44	1.50
H	.186	.191	4.72	4.85
J	.245	.255	6.22	6.48
K	.115	.130	2.92	3.30
L	.064	.070	1.62	1.78
M	—	1.120	—	28.45
N	—	1.585	—	40.26
P	.135	.145	3.42	3.68
Q	.070	.084	1.77	2.13
R	—	.875	—	22.23
S	12.219	12.343	310.36	313.51
T	.137	.153	3.47	3.89

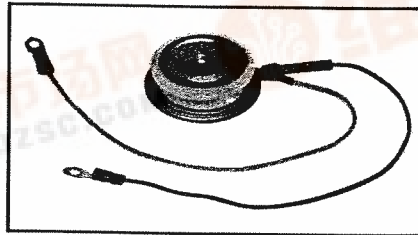

C430
Phase Control SCR
 680 Amperes/500-1300 Volts

Description

Powerex Silicon Controlled Rectifiers (SCR) are designed for phase control applications. These are all-diffused, Press-Pak (Pow-R-Disc) devices employing the field-proven amplifying (di/namic) gate.

Features:

- Low On-State Voltage
- High di/dt
- High dv/dt
- Hermetic Packaging
- Excellent Surge and I²t Ratings

Applications:

- Power Supplies
- Battery Chargers
- Motor Control
- Light Dimmers
- VAR Generators

Ordering Information

Example: Select the complete five or six digit part number you desire from the table – i.e. C430PB is a 1200 Volt, 680 Ampere Phase Control SCR.

Type	Voltage		Current
	V _{DRM} V _{RRM}	Code	
C430	500	E	680
	600	M	
	700	S	
	800	N	
	900	T	
	1000	P	
	1100	PA	
	1200	PB	
	1300	PC	



Powerex, Inc., Hillis Street, Youngwood, Pennsylvania 15697 (412) 925-7272
Powerex Europe, S.A., 428 Ave. G. Durand, BP107, 72003 LeMans, France (43) 72.75.15

C430
Phase Control SCR
680 Amperes Avg/500-1300 Volts

Absolute Maximum Ratings

	Symbol	C430	Units
RMS On-State Current	$I_{T(RMS)}$	1070	Amperes
Average On-State Current	$I_{T(av)}$	680	Amperes
Peak One-Cycle Surge (Non-Repetitive) On-State Current (60Hz)	I_{TSM}	8000	Amperes
Peak One-Cycle Surge (Non-Repetitive) On-State Current (50Hz)	I_{TSM}	7300	Amperes
Critical Rate-of-Rise of On-State Current (Non-Repetitive)	di/dt	400	Amperes/ μ s
Critical Rate-of-Rise of On-State Current (Repetitive)	di/dt	150	Amperes/ μ s
I^2t (for Fusing), One Cycle at 60Hz	I^2t	265,000	A ² sec
Peak Gate Power Dissipation	P_{GM}	20	Watts
Average Gate Power Dissipation	$P_{G(av)}$	5	Watts
Storage Temperature	T_{STG}	-40 to 150	°C
Operating Temperature	T_J	-40 to 125	°C
Mounting Force [ⓐ]		800 to 2500	lb.
Mounting Force [ⓐ]		3.6 to 11.1	kN

[ⓐ] Consult recommended mounting procedures.



Powerex, Inc., Hillis Street, Youngwood, Pennsylvania 15697 (412) 925-7272
 Powerex Europe, S.A., 428 Ave. G. Durand, BP107, 72003 LeMans, France (43) 72.75.15

C430
Phase Control SCR
 680 Amperes Avg/500-1300 Volts

Electrical and Thermal Characteristics

Characteristics	Symbol	Test Conditions	C430	Units
Voltage—Blocking State Maximums				
Forward Leakage, Peak	I_{DRM}	$T_J = 125^\circ\text{C}, V = V_{DRM}$	20	mA
Reverse Leakage, Peak	I_{RRM}	$T_J = 125^\circ\text{C}, V = V_{RRM}$	20	mA
Current—Conducting State Maximums				
Peak On-State Voltage	V_{TM}	$T_C = 25^\circ\text{C}, I_L = 3000\text{A Peak},$ Duty Cycle $\leq 0.01\%$	2.4	Volts
Switching				
Typical Turn-Off Time	t_q	$T_J = 125^\circ\text{C}; I_{TM} = 500\text{A}, V_R = 50\text{V min};$ V_{DRM} (Reapplied); Reapplied $dv/dt = 20\text{V}/\mu\text{sec}$ (linear); Commutation $di/dt = 25\text{A}/\mu\text{sec};$ Repetition Rate = 1 pps; Gate Bias during turn-off interval = 0V; 100 Ω	125	μsec
Typical Delay Time	t_d	$T_C = 25^\circ\text{C}, I_T = 50\text{A},$ Gate Supply: 20 Volts, 20 Ω , 0.1 μsec rise time	0.7	μsec
Min. Critical dv/dt exponential to V_{DRM}	dv/dt	$T_J = 125^\circ\text{C}, V_{DRM} = \text{rated}, \text{Gate Open}$	200	V/ μsec
Thermal				
Maximum Thermal Resistance, [Ⓞ] double sided cooling				
Junction to Case (2000 lb. force)	$R_{\theta JC}$.04	$^\circ\text{C}/\text{Watt}$
Case to Sink, Lubricated (2000 lb. force)	$R_{\theta CS}$.02	$^\circ\text{C}/\text{Watt}$
Gate—Maximum Parameters				
Gate Current to Trigger	I_{GT}	$V_D = 6\text{Vdc}, T_J = 25^\circ\text{C}, R_L = 3\Omega$	125	mA
Gate Voltage to Trigger	V_{GT}	$T_J = -40^\circ\text{C to } 125^\circ\text{C}, V_D = 6\text{Vdc}, R_L = 3\Omega$	5	Volts
Non-Triggering Gate Voltage	V_{GDM}	$T_J = 125^\circ\text{C}, \text{rated } V_{DRM}, R_L = 1000\Omega$.15	Volts
Peak Forward Gate Current	I_{GTM}		10	Amperes
Peak Reverse Gate Voltage	V_{GRM}		5	Volts

Ⓞ Consult recommended mounting procedures.



Powerex, Inc., Hillis Street, Youngwood, Pennsylvania 15697 (412) 925-7272
 Powerex Europe, S.A., 428 Ave. G. Durand, BP107, 72003 LeMans, France (43) 72.75.15

C430
Phase Control SCR
 680 Amperes Avg/500-1300 Volts

MAXIMUM ON-STATE CHARACTERISTICS

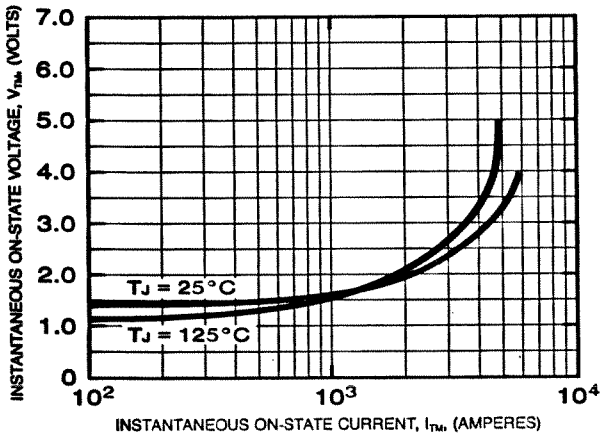

TRANSIENT THERMAL IMPEDANCE CHARACTERISTICS (JUNCTION TO CASE)

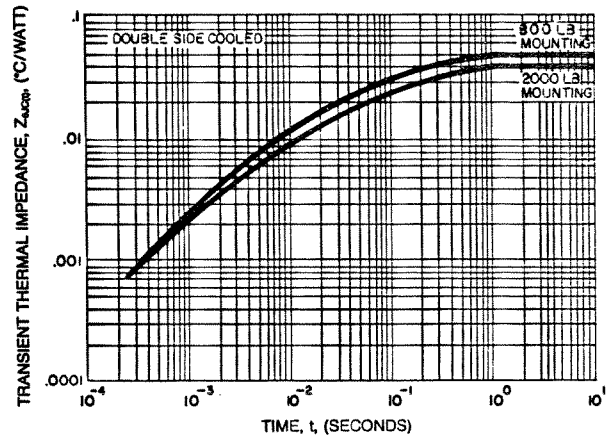

MAXIMUM ALLOWABLE CASE TEMPERATURE (SINUSOIDAL WAVEFORM)

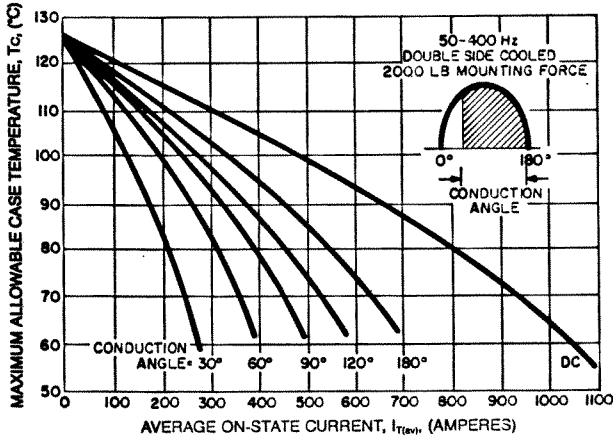

MAXIMUM ON-STATE POWER DISSIPATION (SINUSOIDAL WAVEFORM)

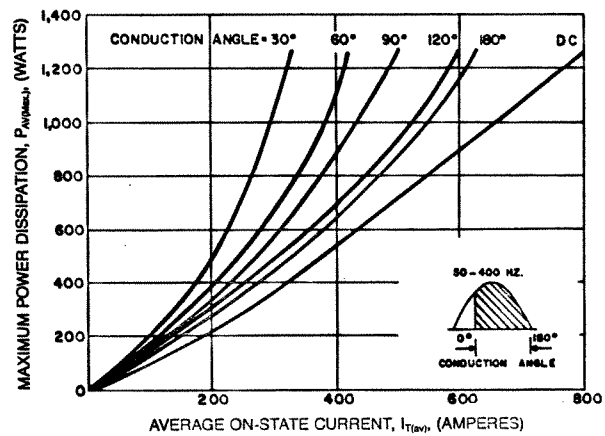

MAXIMUM ALLOWABLE CASE TEMPERATURE (RECTANGULAR WAVEFORM)

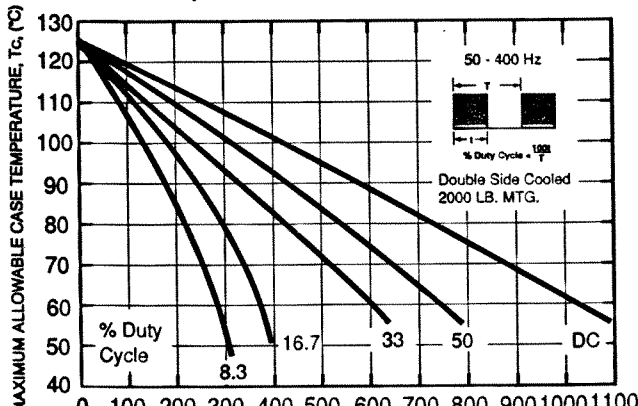

MAXIMUM ON-STATE POWER DISSIPATION (RECTANGULAR WAVEFORM)

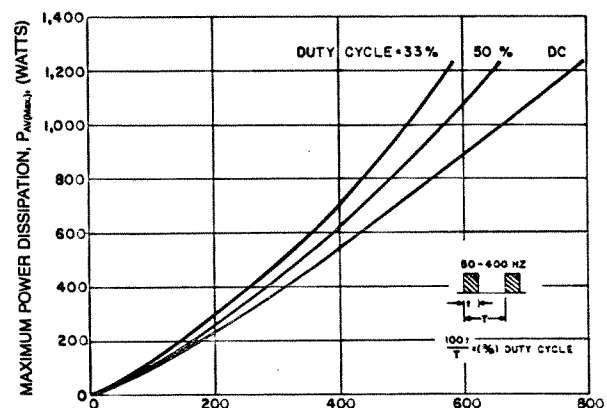



Powerex, Inc., Hillis Street, Youngwood, Pennsylvania 15697 (412) 925-7272

Powerex Europe, S.A., 428 Ave. G. Durand, BP107, 72003 LeMans, France (43) 72.75.15

C430

Phase Control SCR

680 Amperes Avg/500-1300 Volts

MAXIMUM ALLOWABLE CASE TEMPERATURE (SINUSOIDAL WAVEFORM)

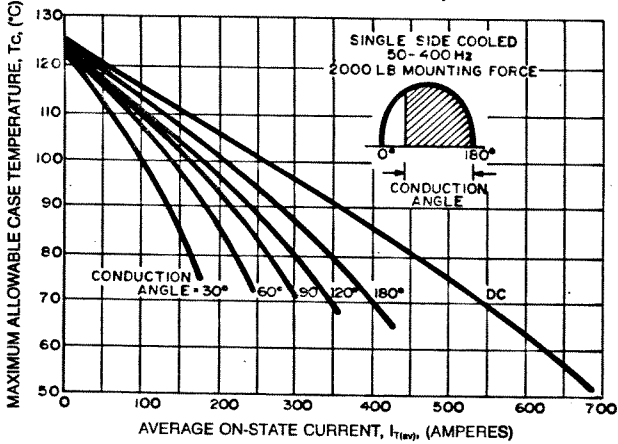

MAXIMUM ALLOWABLE CASE TEMPERATURE (RECTANGULAR WAVEFORM)

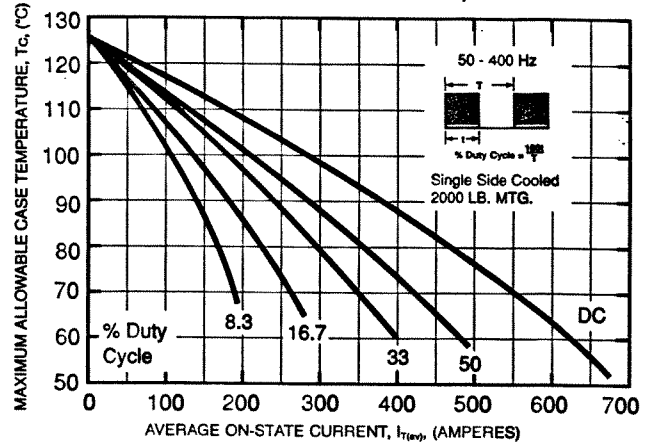

MAXIMUM ALLOWABLE CASE TEMPERATURE (SINUSOIDAL WAVEFORM)

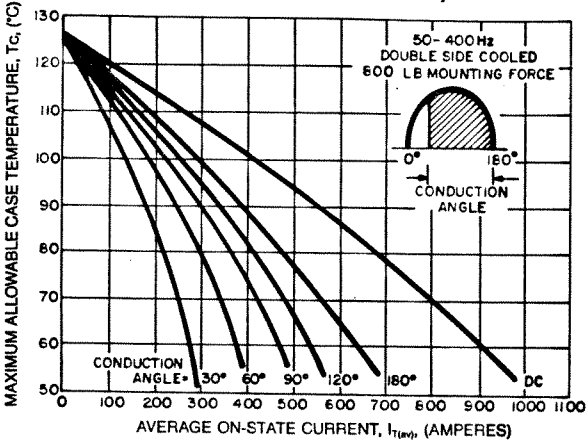

MAXIMUM ALLOWABLE CASE TEMPERATURE (RECTANGULAR WAVEFORM)

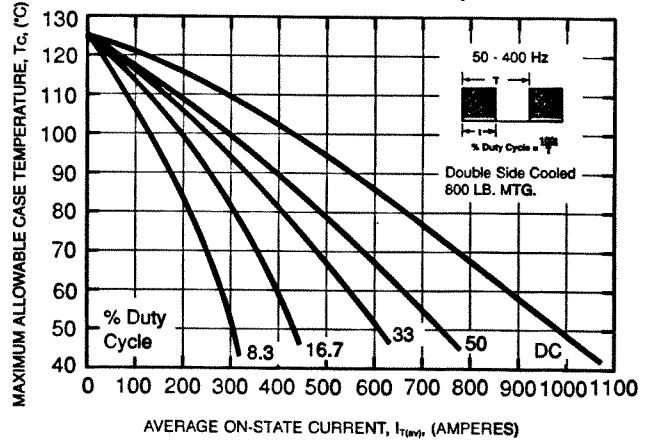

MAXIMUM ALLOWABLE CASE TEMPERATURE (SINUSOIDAL WAVEFORM)

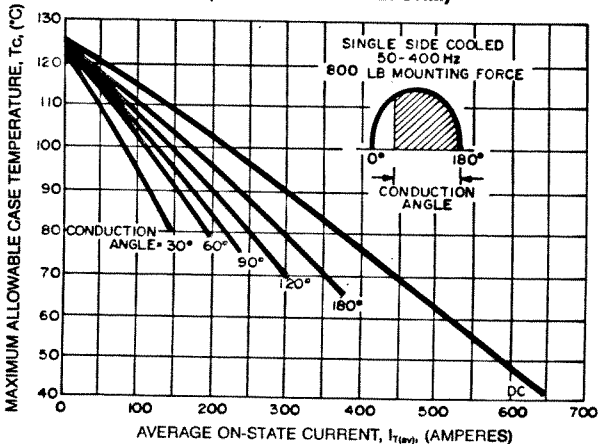

MAXIMUM ALLOWABLE CASE TEMPERATURE (RECTANGULAR WAVEFORM)

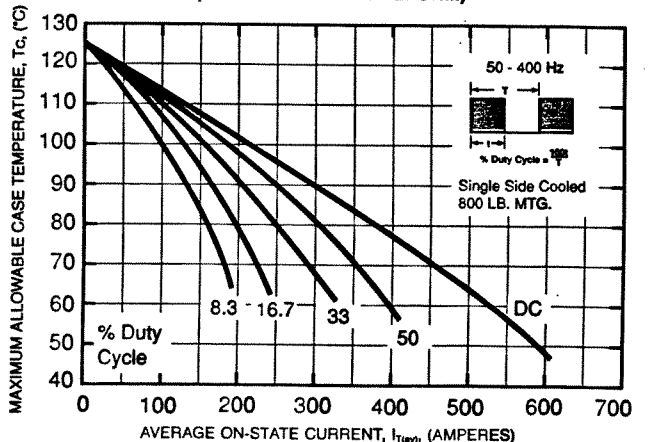

POWEREX

Powerex, Inc., Hillis Street, Youngwood, Pennsylvania 15697 (412) 925-7272
 Powerex Europe, S.A., 428 Ave. G. Durand, BP107, 72003 LeMans, France (43) 72.75.15

C430
Phase Control SCR
 680 Amperes Avg/500-1300 Volts

SUB-CYCLE SURGE AND I^2t RATINGS
 (RATED LOAD CONDITIONS)

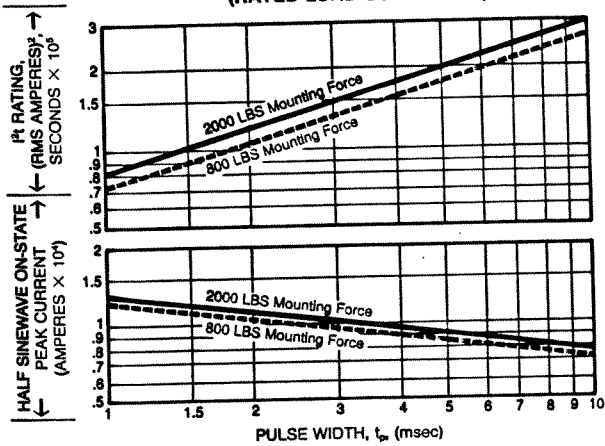

MAXIMUM ALLOWABLE SURGE ON-STATE CURRENT (NON-REPETITIVE)

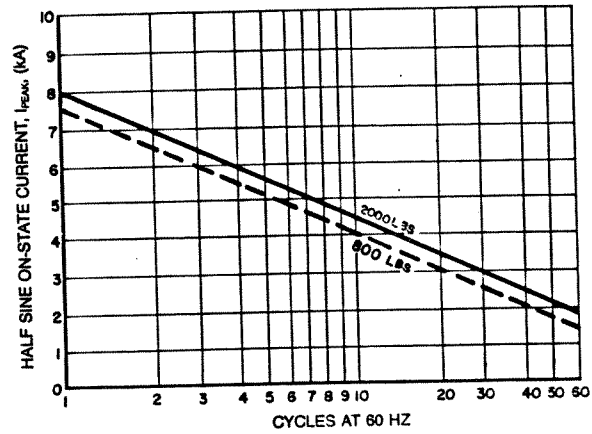

GATE CHARACTERISTICS

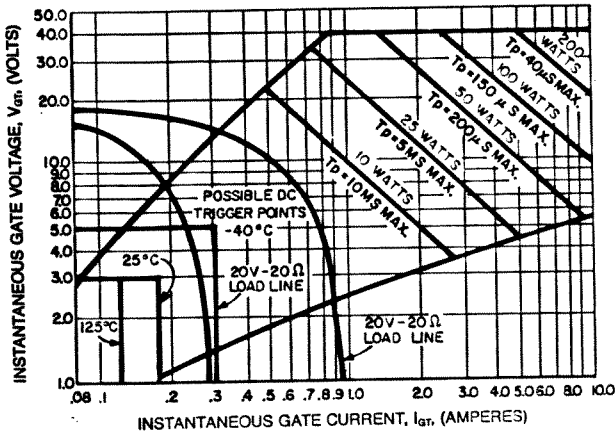

- NOTES:**
- Maximum allowable average gate dissipation = 5 watts.
 - The locus of possible dc trigger points lie outside the boundaries shown at various case temperatures.
 - T_p = Rectangular gate current pulse width (5 μs min. duration; 1.0 μs max. rise time for 20V, 65 Ω source).
 - 20V - 20 Ω is the minimum gate source load line when rate of circuit current rise > 100 Amp/ μs or anode rate of current rise > 200 Amps/ μs (T_p = 5 μs min., 0.5 μs max. rise time).
- Maximum long-term repetitive anode di/dt = 500 Amps/ μs with 20V - 20 Ω gate source.