

## Phase-Locked Loop with VCO and Lock Detector

February 1998 - Revised October 2003

### Features

- Center Frequency of 18MHz (Typ) at  $V_{CC} = 5V$ ,  
Minimum Center Frequency of 12MHz at  $V_{CC} = 4.5V$
- Choice of Two Phase Comparators
  - Exclusive-OR
  - Edge-Triggered JK Flip-Flop
- Excellent VCO Frequency Linearity
- VCO-Inhibit Control for ON/OFF Keying and for Low Standby Power Consumption
- Minimal Frequency Drift
- Zero Voltage Offset Due to Op-Amp Buffer
- Operating Power-Supply Voltage Range
  - VCO Section ..... 3V to 6V
  - Digital Section ..... 2V to 6V
- Fanout (Over Temperature Range)
  - Standard Outputs ..... 10 LSTTL Loads
  - Bus Driver Outputs ..... 15 LSTTL Loads
- Wide Operating Temperature Range . . . -55°C to 125°C
- Balanced Propagation Delay and Transition Times
- Significant Power Reduction Compared to LSTTL Logic ICs
- HC Types
  - 2V to 6V Operation
  - High Noise Immunity:  $N_{IL} = 30%$ ,  $N_{IH} = 30%$  of  $V_{CC}$  at  $V_{CC} = 5V$
- HCT Types
  - 4.5V to 5.5V Operation
  - Direct LSTTL Input Logic Compatibility,  $V_{IL} = 0.8V$  (Max),  $V_{IH} = 2V$  (Min)
  - CMOS Input Compatibility,  $I_I \leq 1\mu A$  at  $V_{OL}$ ,  $V_{OH}$

### Applications

- FM Modulation and Demodulation
- Frequency Synthesis and Multiplication
- Frequency Discrimination
- Tone Decoding
- Data Synchronization and Conditioning
- Voltage-to-Frequency Conversion
- Motor-Speed Control
- Related Literature
  - AN8823, CMOS Phase-Locked-Loop Application Using the CD74HC/HCT7046A and CD74HC/HCT7046A

### Description

The CD74HC7046A and CD74HCT7046A high-speed silicon-gate CMOS devices, specified in compliance with JEDEC Standard No. 7A, are phase-locked-loop (PLL) circuits that contain a linear voltage-controlled oscillator (VCO), two-phase comparators (PC1, PC2), and a lock detector. A signal input and a comparator input are common to each comparator. The lock detector gives a HIGH level at pin 1 (LD) when the PLL is locked. The lock detector capacitor must be connected between pin 15 ( $C_{LD}$ ) and pin 8 (Gnd). For a frequency range of 100kHz to 10MHz, the lock detector capacitor should be 1000pF to 10pF, respectively.

The signal input can be directly coupled to large voltage signals, or indirectly coupled (with a series capacitor) to small voltage signals. A self-bias input circuit keeps small voltage signals within the linear region of the input amplifiers. With a passive low-pass filter, the 7046A forms a second-order loop PLL. The excellent VCO linearity is achieved by the use of linear op-amp techniques.

### Ordering Information

PART NUMBER	TEMP. RANGE (°C)	PACKAGE
CD74HC7046AE	-55 to 125	16 Ld PDIP
CD74HC7046AM	-55 to 125	16 Ld SOIC
CD74HC7046AMT	-55 to 125	16 Ld SOIC
CD74HC7046AM96	-55 to 125	16 Ld SOIC
CD74HCT7046AE	-55 to 125	16 Ld PDIP
CD74HCT7046AM	-55 to 125	16 Ld SOIC
CD74HCT7046AMT	-55 to 125	16 Ld SOIC
CD74HCT7046AM96	-55 to 125	16 Ld SOIC

NOTE: When ordering, use the entire part number. The suffix 96 denotes tape and reel. The suffix T denotes a small-quantity reel of 250.

# CD74HC7046A, CD74HCT7046A

## Pinout

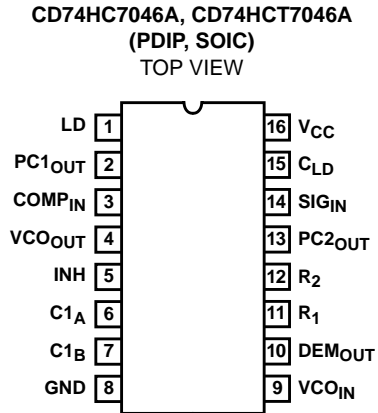

## Functional Diagram

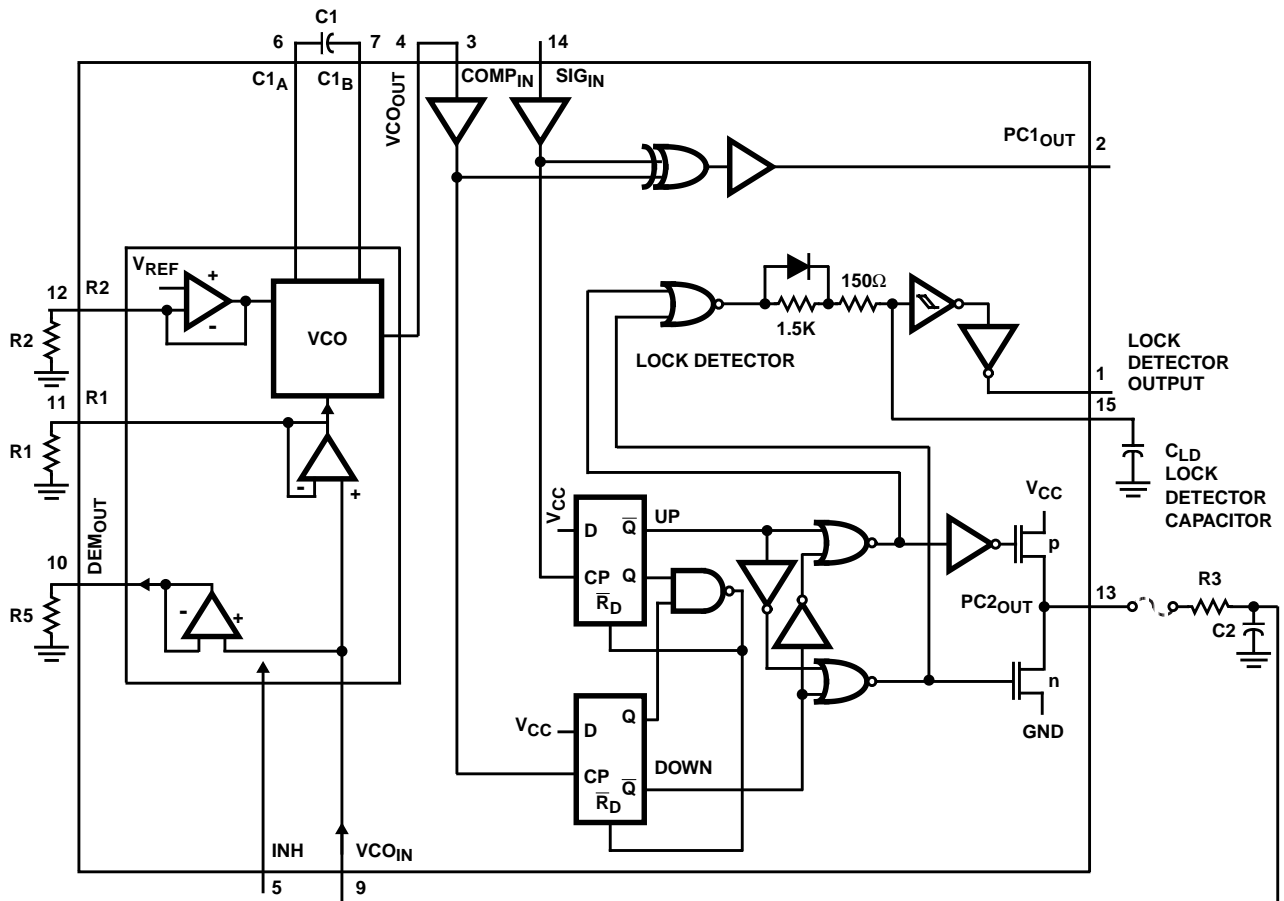
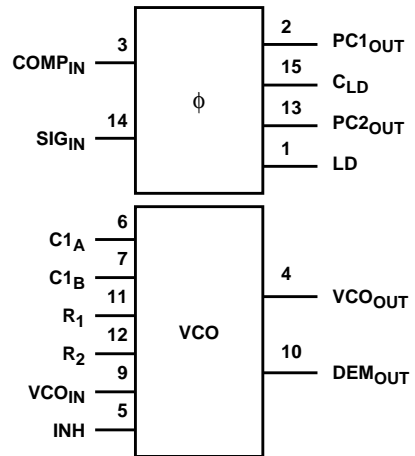

FIGURE 1. LOGIC DIAGRAM

**Pin Descriptions**

PIN NO.	SYMBOL	NAME AND FUNCTION
1	LD	Lock Detector Output (Active High)
2	PC1 <sub>OUT</sub>	Phase Comparator 1 Output
3	COMP <sub>IN</sub>	Comparator Input
4	VCO <sub>OUT</sub>	VCO Output
5	INH	Inhibit Input
6	C1 <sub>A</sub>	Capacitor C1 Connection A
7	C1 <sub>B</sub>	Capacitor C1 Connection B
8	Gnd	Ground (0V)
9	VCO <sub>IN</sub>	VCO Input
10	DEM <sub>OUT</sub>	Demodulator Output
11	R1	Resistor R1 Connection
12	R2	Resistor R2 Connection
13	PC2 <sub>OUT</sub>	Phase Comparator 2 Output
14	SIG <sub>IN</sub>	Signal Input
15	C <sub>LD</sub>	Lock Detector Capacitor Input
16	V <sub>CC</sub>	Positive Supply Voltage

**General Description**

**VCO**

The VCO requires one external capacitor C1 (between C1<sub>A</sub> and C1<sub>B</sub>) and one external resistor R1 (between R1 and Gnd) or two external resistors R1 and R2 (between R1 and Gnd, and R2 and Gnd). Resistor R1 and capacitor C1 determine the frequency range of the VCO. Resistor R2 enables the VCO to have a frequency offset if required. See logic diagram, Figure 1.

The high input impedance of the VCO simplifies the design of low-pass filters by giving the designer a wide choice of resistor/capacitor ranges. In order not to load the low-pass filter, a demodulator output of the VCO input voltage is provided at pin 10 (DEM<sub>OUT</sub>). In contrast to conventional techniques where the DEM<sub>OUT</sub> voltage is one threshold voltage lower than the VCO input voltage, here the DEM<sub>OUT</sub> voltage equals that of the VCO input. If DEM<sub>OUT</sub> is used, a load resistor (R<sub>S</sub>) should be connected from DEM<sub>OUT</sub> to Gnd; if unused, DEM<sub>OUT</sub> should be left open. The VCO output (VCO<sub>OUT</sub>) can be connected directly to the comparator input (COMP<sub>IN</sub>), or connected via a frequency-divider. The VCO output signal has a specified duty factor of 50%. A LOW level at the inhibit input (INH) enables the VCO, while a HIGH level disables the VCO to minimize standby power consumption.

**Phase Comparators**

The signal input (SIG<sub>IN</sub>) can be directly coupled to the self-biasing amplifier at pin 14, provided that the signal swing is between the standard HC family input logic levels, Capacitive coupling is required for signals with smaller swings.

**Phase Comparator 1 (PC1)**

This is an Exclusive-OR network. The signal and comparator input frequencies (f<sub>i</sub>) must have a 50% duty factor to obtain the maximum locking range. The transfer characteristic of PC1, assuming ripple (f<sub>r</sub> = 2f<sub>i</sub>) is suppressed, is:

$$V_{DEMOUT} = (V_{CC}/\pi) (\phi_{SIGIN} - \phi_{COMPIN})$$

where V<sub>DEMOUT</sub> is the demodulator output at pin 10; V<sub>DEMOUT</sub> = V<sub>PC1OUT</sub> (via low-pass filter).

The average output voltage from PC1, fed to the VCO input via the low-pass filter and seen at the demodulator output at pin 10 (V<sub>DEMOUT</sub>), is the resultant of the phase differences of signals (SIG<sub>IN</sub>) and the comparator input (COMP<sub>IN</sub>) as shown in Figure 2. The average of V<sub>DEM</sub> is equal to 1/2 V<sub>CC</sub> when there is no signal or noise at SIG<sub>IN</sub>, and with this input the VCO oscillates at the center frequency (f<sub>0</sub>). Typical waveforms for the PC1 loop locked at f<sub>0</sub> shown in Figure 3.

The frequency capture range (2f<sub>c</sub>) is defined as the frequency range of input signals on which the PLL will lock if it was initially out-of-lock. The frequency lock range (2f<sub>L</sub>) is defined as the frequency range of input signals on which the loop will stay locked if it was initially in lock. The capture range is smaller or equal to the lock range.

With PC1, the capture range depends on the low-pass filter characteristics and can be made as large as the lock range. This configuration retains lock behavior even with very noisy input signals. Typical of this type of phase comparator is that it can lock to input frequencies close to the harmonics of the VCO center frequency.

**Phase Comparator 2 (PC2)**

This is a positive edge-triggered phase and frequency detector. When the PLL is using this comparator, the loop is controlled by positive signal transitions and the duty factors of SIG<sub>IN</sub> and COMP<sub>IN</sub> are not important. PC2 comprises two D-type flip-flops, control-gating and a three-state output stage. The circuit functions as an up-down counter (Figure 1) where SIG<sub>IN</sub> causes an up-count and COMP<sub>IN</sub> a down-count. The transfer function of PC2, assuming ripple (f<sub>r</sub> = f<sub>i</sub>) is suppressed, is:

$$V_{DEMOUT} = (V_{CC}/4\pi) (\phi_{SIGIN} - \phi_{COMPIN})$$

where V<sub>DEMOUT</sub> is the demodulator output at pin 10; V<sub>DEMOUT</sub> = V<sub>PC2OUT</sub> (via low-pass filter).

The average output voltage from PC2, fed to the VCO via the low-pass filter and seen at the demodulator output at pin 10 (V<sub>DEMOUT</sub>), is the resultant of the phase differences of SIG<sub>IN</sub> and COMP<sub>IN</sub> as shown in Figure 4. Typical waveforms for the PC2 loop locked at f<sub>0</sub> are shown in Figure 5.

When the frequencies of SIG<sub>IN</sub> and COMP<sub>IN</sub> are equal but the phase of SIG<sub>IN</sub> leads that of COMP<sub>IN</sub>, the p-type output driver at PC2<sub>OUT</sub> is held "ON" for a time corresponding to the phase differences (φ<sub>DEMOUT</sub>). When the phase of SIG<sub>IN</sub> lags that of COMP<sub>IN</sub>, the n-type driver is held "ON".

When the frequency of SIG<sub>IN</sub> is higher than that of COMP<sub>IN</sub>, the p-type output driver is held "ON" for most of the input signal cycle time, and for the remainder of the cycle both n-type and p-type drivers are "OFF" (three-state). If the SIG<sub>IN</sub> fre-

quency is lower than the COMP<sub>IN</sub> frequency, then it is the n-type driver that is held "ON" for most of the cycle. Subsequently, the voltage at the capacitor (C2) of the low-pass filter connected to PC2<sub>OUT</sub> varies until the signal and comparator inputs are equal in both phase and frequency. At this stable point the voltage on C2 remains constant as the PC2 output is in three-state and the VCO input at pin 9 is a high impedance.

Thus, for PC2, no phase difference exists between SIG<sub>IN</sub> and COMP<sub>IN</sub> over the full frequency range of the VCO. Moreover, the power dissipation due to the low-pass filter is reduced because both p-type and n-type drivers are "OFF" for most of the signal input cycle. It should be noted that the PLL lock range for this type of phase comparator is equal to the capture range and is independent of the low-pass filter. With no signal present at SIG<sub>IN</sub>, the VCO adjusts, via PC2, to its lowest frequency.

**Lock Detector Theory of Operation**

Detection of a locked condition is accomplished by a NOR gate and an envelope detector as shown in Figure 6. When the PLL is in Lock, the output of the NOR gate is High and the lock detector output (Pin 1) is at a constant high level. As the loop tracks the signal on Pin 14 (signal in), the NOR gate outputs pulses whose widths represent the phase differences between the VCO and the input signal. The time between pulses will be approximately equal to the time constant of the VCO center frequency. During the rise time of the pulse, the diode across the 1.5kΩ resistor is forward

biased and the time constant in the path that charges the lock detector capacitor is  $T = (150\Omega \times C_{LD})$ .

During the fall time of the pulse the capacitor discharges through the 1.5kΩ and the 150Ω resistors and the channel resistance of the n-device of the NOR gate to ground ( $T = (1.5k\Omega + 150\Omega + R_{n-channel}) \times C_{LD}$ ).

The waveform preset at the capacitor resembles a sawtooth as shown in Figure 7. The lock detector capacitor value is determined by the VCO center frequency. The typical range of capacitor for a frequency of 10MHz is about 10pF and for a frequency of 100kHz is about 1000pF. The chart in Figure 8 can be used to select the proper lock detector capacitor value. As long as the loop remains locked and tracking, the level of the sawtooth will not go below the switching threshold of the Schmitt-trigger inverter. If the loop breaks lock, the width of the error pulse will be wide enough to allow the sawtooth waveform to go below threshold and a level change at the output of the Schmitt trigger will indicate a loss of lock, as shown in Figure 9. The lock detector capacitor also acts to filter out small glitches that can occur when the loop is either seeking or losing lock.

Note: When using phase comparator 1, the detector will only indicate a lock condition on the fundamental frequency and not on the harmonics, which PC1 will also lock on. If a detection of lock is needed over the harmonic locking range of PC1, then the lock detector output must be OR-ed with the output of PC1.

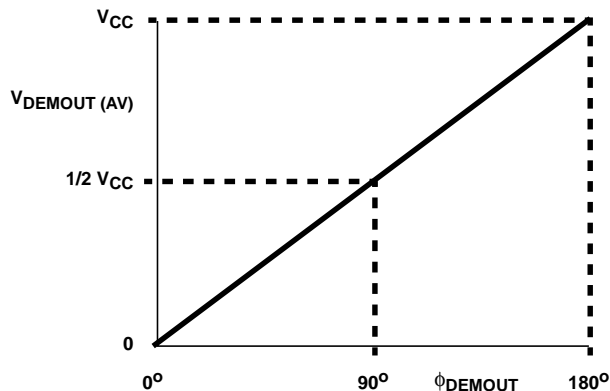

**FIGURE 2. PHASE COMPARATOR 1: AVERAGE OUTPUT VOLTAGE vs INPUT PHASE DIFFERENCE:**  
 $V_{DEMOUT} = V_{PC1OUT} = (V_{CC}/\pi) (\phi_{SIGIN} - \phi_{COMPIN})$ ;  
 $\phi_{DEMOUT} = (\phi_{SIGIN} - \phi_{COMPIN})$

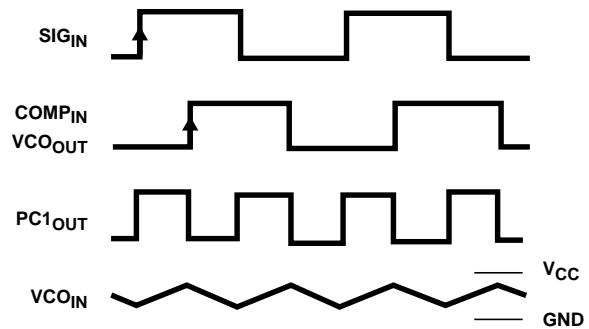

**FIGURE 3. TYPICAL WAVEFORMS FOR PLL USING PHASE COMPARATOR 1, LOOP LOCKED AT  $f_0$**

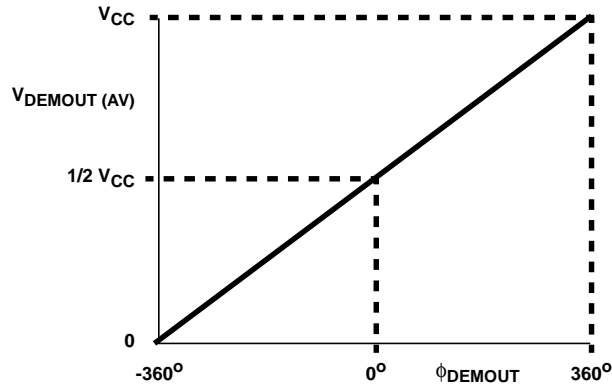

FIGURE 4. PHASE COMPARATOR 2: AVERAGE OUTPUT VOLTAGE vs INPUT PHASE DIFFERENCE:  
 $V_{\text{DEMOUT}} = V_{\text{PC2OUT}} = (V_{\text{CC}}/\pi) (\phi_{\text{SIGIN}} - \phi_{\text{COMPIN}})$ ;  
 $\phi_{\text{DEMOUT}} = (\phi_{\text{SIGIN}} - \phi_{\text{COMPIN}})$

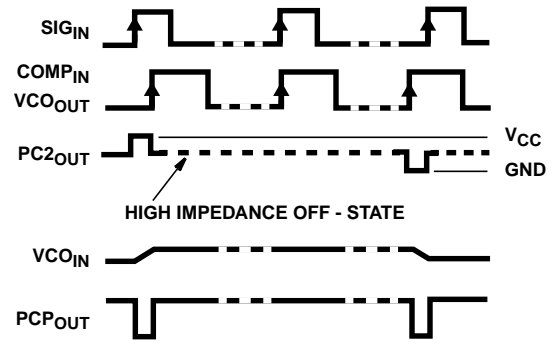

FIGURE 5. TYPICAL WAVEFORMS FOR PLL USING PHASE COMPARATOR 2, LOOP LOCKED AT  $f_0$

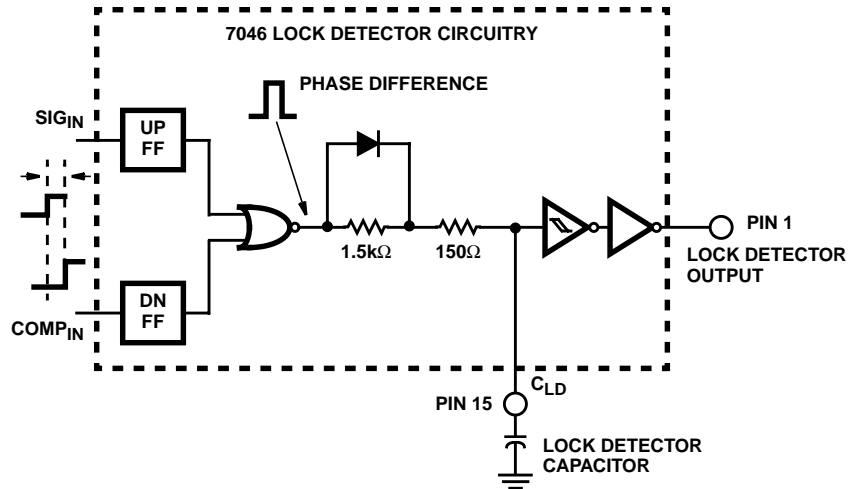

FIGURE 6. CD74HC/HCT7046A LOCK DETECTOR CIRCUIT

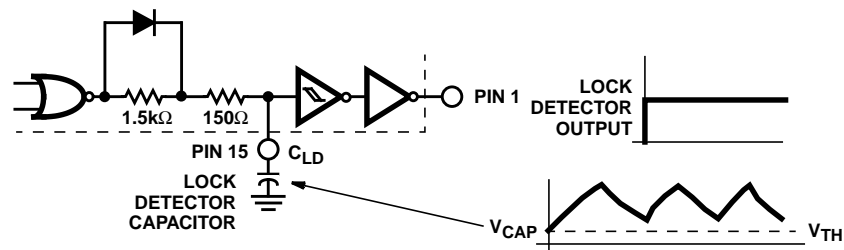

FIGURE 7. WAVEFORM PRESENT AT LOCK DETECTOR CAPACITOR WHEN IN LOCK

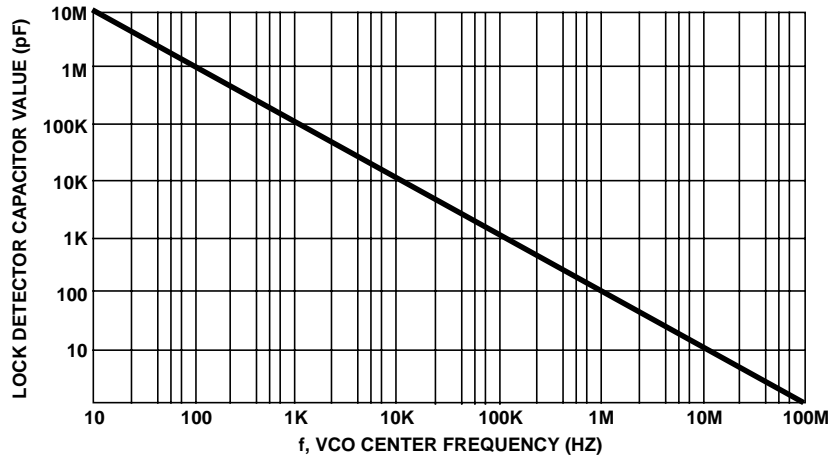

FIGURE 8. LOCK DETECTOR CAPACITOR SELECTION CHART

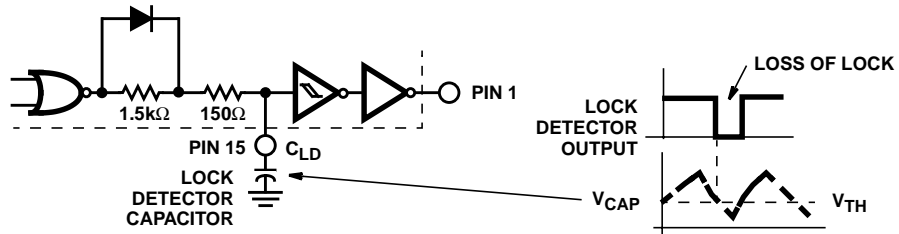

FIGURE 9. WAVEFORM PRESENT AT LOCK DETECTOR CAPACITOR WHEN UNLOCKED

## CD74HC7046A, CD74HCT7046A

### Absolute Maximum Ratings

DC Supply Voltage, $V_{CC}$ .....	-0.5V to 7V
DC Input Diode Current, $I_{IK}$	
For $V_I < -0.5V$ or $V_I > V_{CC} + 0.5V$ .....	$\pm 20mA$
DC Output Diode Current, $I_{OK}$	
For $V_O < -0.5V$ or $V_O > V_{CC} + 0.5V$ .....	$\pm 20mA$
DC Output Source or Sink Current per Output Pin, $I_O$	
For $V_O > -0.5V$ or $V_O < V_{CC} + 0.5V$ .....	$\pm 25mA$
DC $V_{CC}$ or Ground Current, $I_{CC}$ .....	$\pm 50mA$

### Thermal Information

Thermal Resistance (Typical, Note 1)	$\theta_{JA}$ (°C/W)
E (PDIP) Package .....	67
M (SOIC) Package .....	73
Maximum Junction Temperature .....	150°C
Maximum Storage Temperature Range .....	-65°C to 150°C
Maximum Lead Temperature (Soldering 10s) .....	300°C (SOIC - Lead Tips Only)

### Operating Conditions

Temperature Range, $T_A$ .....	-55°C to 125°C
Supply Voltage Range, $V_{CC}$	
HC Types .....	.2V to 6V
HCT Types .....	4.5V to 5.5V
DC Input or Output Voltage, $V_I, V_O$ .....	0V to $V_{CC}$
Input Rise and Fall Time	
2V .....	1000ns (Max)
4.5V .....	500ns (Max)
6V .....	400ns (Max)

*CAUTION: Stresses above those listed in "Absolute Maximum Ratings" may cause permanent damage to the device. This is a stress only rating and operation of the device at these or any other conditions above those indicated in the operational sections of this specification is not implied.*

#### NOTE:

- The package thermal impedance is calculated in accordance with JESD 51-7.

### DC Electrical Specifications

PARAMETER	SYMBOL	TEST CONDITIONS		$V_{CC}$ (V)	25°C			-40°C TO 85°C		-55°C TO 125°C		UNITS
		$V_I$ (V)	$I_O$ (mA)		MIN	TYP	MAX	MIN	MAX	MIN	MAX	
<b>HC TYPES</b>												
<b>VCO SECTION</b>												
INH High Level Input Voltage	$V_{IH}$	-	-	3	2.1	-	-	2.1	-	2.1	-	V
				4.5	3.15	-	-	3.15	-	3.15	-	V
				6	4.2	-	-	4.2	-	4.2	-	V
INH Low Level Input Voltage	$V_{IL}$	-	-	3	-	-	0.9	-	0.9	-	0.9	V
				4.5	-	-	1.35	-	1.35	-	1.35	V
				6	-	-	1.8	-	1.8	-	1.8	V
VCO <sub>OUT</sub> High Level Output Voltage CMOS Loads	$V_{OH}$	$V_{IH}$ or $V_{IL}$	-0.02	3	2.9	-	-	2.9	-	2.9	-	V
			-0.02	4.5	4.4	-	-	4.4	-	4.4	-	V
			-0.02	6	5.9	-	-	5.9	-	5.9	-	V
VCO <sub>OUT</sub> High Level Output Voltage TTL Loads	$V_{OH}$	$V_{IH}$ or $V_{IL}$	-	-	-	-	-	-	-	-	-	V
			-4	4.5	3.98	-	-	3.84	-	3.7	-	V
			-5.2	6	5.48	-	-	5.34	-	5.2	-	V
VCO <sub>OUT</sub> Low Level Output Voltage CMOS Loads	$V_{OL}$	$V_{IH}$ or $V_{IL}$	0.02	2	-	-	0.1	-	0.1	-	0.1	V
			0.02	4.5	-	-	0.1	-	0.1	-	0.1	V
			0.02	6	-	-	0.1	-	0.1	-	0.1	V
VCO <sub>OUT</sub> Low Level Output Voltage TTL Loads	$V_{OL}$	$V_{IH}$ or $V_{IL}$	-	-	-	-	-	-	-	-	-	V
			4	4.5	-	-	0.26	-	0.33	-	0.4	V
			5.2	6	-	-	0.26	-	0.33	-	0.4	V
C1A, C1B Low Level Output Voltage (Test Purposes Only)	$V_{OL}$	$V_{IL}$ or $V_{OL}$	4	4.5	-	-	0.40	-	0.47	-	0.54	V
			5.2	6	-	-	0.40	-	0.47	-	0.54	V

**CD74HC7046A, CD74HCT7046A**

**DC Electrical Specifications (Continued)**

PARAMETER	SYMBOL	TEST CONDITIONS		V <sub>CC</sub> (V)	25°C			-40°C TO 85°C		-55°C TO 125°C		UNITS
		V <sub>I</sub> (V)	I <sub>O</sub> (mA)		MIN	TYP	MAX	MIN	MAX	MIN	MAX	
INH VCO <sub>IN</sub> Input Leakage Current	I <sub>I</sub>	V <sub>CC</sub> or GND	-	6	-	-	±0.1	-	±1	-	±1	µA
R1 Range (Note 2)	-	-	-	4.5	3	-	-	-	-	-	-	kΩ
R2 Range (Note 2)	-	-	-	4.5	3	-	-	-	-	-	-	kΩ
C1 Capacitance Range	-	-	-	3	-	-	No Limit	-	-	-	-	pF
				4.5	40	-		-	-	-	pF	
				6	-	-		-	-	-	pF	
VCO <sub>IN</sub> Operating Voltage Range	-	Over the range specified for R1 for Linearity See Figure 8, and 35 - 38 (Note 3)		3	1.1	-	1.9	-	-	-	-	V
				4.5	1.1	-	3.2	-	-	-	-	V
				6	1.1	-	4.6	-	-	-	-	V
<b>PHASE COMPARATOR SECTION</b>												
SIG <sub>IN</sub> , COMP <sub>IN</sub> DC Coupled High-Level Input Voltage	V <sub>IH</sub>	-	-	2	1.5	-	-	1.5	-	1.5	-	V
				4.5	3.15	-	-	3.15	-	3.15	-	V
				6	4.2	-	-	4.2	-	4.2	-	V
SIG <sub>IN</sub> , COMP <sub>IN</sub> DC Coupled Low-Level Input Voltage	V <sub>IL</sub>	-	-	2	-	-	0.5	-	0.5	-	0.5	V
				4.5	-	-	1.35	-	1.35	-	1.35	V
				6	-	-	1.8	-	1.8	-	1.8	V
LD, PC <sub>N</sub> OUT High-Level Output Voltage CMOS Loads	V <sub>OH</sub>	V <sub>IL</sub> or V <sub>IH</sub>	-0.02	2	1.9	-	-	1.9	-	1.9	-	V
				4.5	4.4	-	-	4.4	-	4.4	-	V
				6	5.9	-	-	5.9	-	5.9	-	V
LD, PC <sub>N</sub> OUT High-Level Output Voltage TTL Loads	V <sub>OH</sub>	V <sub>IL</sub> or V <sub>IH</sub>	-4	4.5	3.98	-	-	3.84	-	3.7	-	V
				6	5.48	-	-	5.34	-	5.2	-	V
LD, PC <sub>N</sub> OUT Low-Level Output Voltage CMOS Loads	V <sub>OL</sub>	V <sub>IL</sub> or V <sub>IH</sub>	0.02	2	-	-	0.1	-	0.1	-	0.1	V
				4.5	-	-	0.1	-	0.1	-	0.1	V
				6	-	-	0.1	-	0.1	-	0.1	V
LD, PC <sub>N</sub> OUT Low-Level Output Voltage TTL Loads	V <sub>OL</sub>	V <sub>IL</sub> or V <sub>IH</sub>	4	4.5	-	-	0.26	-	0.33	-	0.4	V
				6	-	-	0.26	-	0.33	-	0.4	V
SIG <sub>IN</sub> , COMP <sub>IN</sub> Input Leakage Current	I <sub>I</sub>	V <sub>CC</sub> or GND	-	2	-	-	±3	-	±4	-	±5	µA
				3	-	-	±7	-	±9	-	±11	µA
				4.5	-	-	±18	-	±23	-	±29	µA
				6	-	-	±30	-	±38	-	±45	µA
PC <sub>2</sub> OUT Three-State Off-State Current	I <sub>OZ</sub>	V <sub>IL</sub> or V <sub>IH</sub>	-	6	-	-	±0.5	-	±5	-	±10	µA
SIG <sub>IN</sub> , COMP <sub>IN</sub> Input Resistance	R <sub>I</sub>	V <sub>I</sub> at Self-Bias Operation Point: ΔV <sub>I</sub> = 0.5V, See Figure 8		3	-	800	-	-	-	-	-	kΩ
				4.5	-	250	-	-	-	-	-	kΩ
				6	-	150	-	-	-	-	-	kΩ
<b>DEMODULATOR SECTION</b>												
Resistor Range	R <sub>S</sub>	at R <sub>S</sub> > 300kΩ Leakage Current Can Influence V <sub>DEMOUT</sub>		3	10	-	300	-	-	-	-	kΩ
				4.5	10	-	300	-	-	-	-	kΩ
				6	10	-	300	-	-	-	-	kΩ



**CD74HC7046A, CD74HCT7046A**

**DC Electrical Specifications (Continued)**

PARAMETER	SYMBOL	TEST CONDITIONS		V <sub>CC</sub> (V)	25°C			-40°C TO 85°C		-55°C TO 125°C		UNITS
		V <sub>I</sub> (V)	I <sub>O</sub> (mA)		MIN	TYP	MAX	MIN	MAX	MIN	MAX	
Offset Voltage V <sub>COIN</sub> to V <sub>DEM</sub>	V <sub>OFF</sub>	V <sub>I</sub> = V <sub>VCOIN</sub> = $\frac{V_{CC}}{2}$ Values taken over R <sub>S</sub> Range See Figure 15		3	-	±30	-	-	-	-	-	mV
				4.5	-	±20	-	-	-	-	-	mV
				6	-	±10	-	-	-	-	-	mV
Dynamic Output Resistance at DEM <sub>OUT</sub>	R <sub>O</sub>	V <sub>DEMOUT</sub> = $\frac{V_{CC}}{2}$		3	-	25	-	-	-	-	-	Ω
				4.5	-	25	-	-	-	-	-	Ω
				6	-	25	-	-	-	-	-	Ω
Quiescent Device Current	I <sub>CC</sub>	Pins 3, 5 and 14 at V <sub>CC</sub> Pin 9 at GND, I <sub>I</sub> at Pins 3 and 14 to be excluded		6	-	-	8	-	80	-	160	μA

**HCT TYPES**

**VCO SECTION**

INH High Level Input Voltage	V <sub>IH</sub>	-	-	4.5 to 5.5	2	-	-	2	-	2	-	V
INH Low Level Input Voltage	V <sub>IL</sub>	-	-	4.5 to 5.5	-	-	0.8	-	0.8	-	0.8	V
VCO <sub>OUT</sub> High Level Output Voltage CMOS Loads	V <sub>OH</sub>	V <sub>IH</sub> or V <sub>IL</sub>	-0.02	4.5	4.4	-	-	4.4	-	4.4	-	V
VCO <sub>OUT</sub> High Level Output Voltage TTL Loads			-4	4.5	3.98	-	-	3.84	-	3.7	-	V
VCO <sub>OUT</sub> Low Level Output Voltage CMOS Loads	V <sub>OL</sub>	V <sub>IH</sub> or V <sub>IL</sub>	0.02	4.5	-	-	0.1	-	0.1	-	0.1	V
VCO <sub>OUT</sub> Low Level Output Voltage TTL Loads			4	4.5	-	-	0.26	-	0.33	-	0.4	V
C1A, C1B Low Level Output Voltage (Test Purposes Only)	V <sub>OL</sub>	V <sub>IH</sub> or V <sub>IL</sub>	4	4.5	-	-	0.40	-	0.47	-	0.54	V
INH VCO <sub>IN</sub> Input Leakage Current	I <sub>I</sub>	Any Voltage Between V <sub>CC</sub> and GND		5.5	-	-	±0.1	-	±1	-	±1	μA
R1 Range (Note 2)	-	-	-	4.5	3	-	-	-	-	-	-	kΩ
R2 Range (Note 2)	-	-	-	4.5	3	-	-	-	-	-	-	kΩ
C1 Capacitance Range	-	-	-	4.5	40	-	No Limit	-	-	-	-	pF
VCO <sub>IN</sub> Operating Voltage Range	-	Over the range specified for R1 for Linearity See Figure 8, and 35 - 38 (Note 3)		4.5	1.1	-	3.2	-	-	-	-	V

**PHASE COMPARATOR SECTION**

SIG <sub>IN</sub> , COMP <sub>IN</sub> DC Coupled High-Level Input Voltage	V <sub>IH</sub>	-	-	4.5 to 5.5	3.15	-	-	3.15	-	3.15	-	V
--	-----------------	---	---	------------	------	---	---	------	---	------	---	---

**CD74HC7046A, CD74HCT7046A**

**DC Electrical Specifications (Continued)**

PARAMETER	SYMBOL	TEST CONDITIONS		V <sub>CC</sub> (V)	25°C			-40°C TO 85°C		-55°C TO 125°C		UNITS
		V <sub>I</sub> (V)	I <sub>O</sub> (mA)		MIN	TYP	MAX	MIN	MAX	MIN	MAX	
SIG <sub>IN</sub> , COMP <sub>IN</sub> DC Coupled Low-Level Input Voltage	V <sub>IL</sub>	-	-	4.5 to 5.5	-	-	1.35	-	1.35	-	1.35	V
LD, PC <sub>N</sub> OUT High- Level Output Voltage CMOS Loads	V <sub>OH</sub>	V <sub>IL</sub> or V <sub>IH</sub>	-	4.5	4.4	-	-	4.4	-	4.4	-	V
LD, PC <sub>N</sub> OUT High- Level Output Voltage TTL Loads	V <sub>OH</sub>	V <sub>IL</sub> or V <sub>IH</sub>	-	4.5	3.98	-	-	3.84	-	3.7	-	V
LD, PC <sub>N</sub> OUT Low- Level Output Voltage CMOS Loads	V <sub>OL</sub>	V <sub>IL</sub> or V <sub>IH</sub>	-	4.5	-	-	0.1	-	0.1	-	0.1	V
LD, PC <sub>N</sub> OUT Low- Level Output Voltage TTL Loads	V <sub>OL</sub>	V <sub>IL</sub> or V <sub>IH</sub>	-	4.5	-	-	0.26	-	0.33	-	0.4	V
SIG <sub>IN</sub> , COMP <sub>IN</sub> Input Leakage Current	I <sub>I</sub>	Any Voltage Between V <sub>CC</sub> and GND	-	5.5	-	-	±30	-	±38	-	±45	μA
PC <sub>2</sub> OUT Three-State Off-State Current	I <sub>OZ</sub>	V <sub>IL</sub> or V <sub>IH</sub>	-	5.5	-	-	±0.5	±5	-	-	±10	μA
SIG <sub>IN</sub> , COMP <sub>IN</sub> Input Resistance	R <sub>I</sub>	V <sub>I</sub> at Self-Bias Operation Point: ΔV, 0.5V, See Figure 8		4.5	-	250	-	-	-	-	-	kΩ
<b>DEMODULATOR SECTION</b>												
Resistor Range	R <sub>S</sub>	at R <sub>S</sub> > 300kΩ Leakage Current Can Influence V <sub>DEMOUT</sub>		4.5	10	-	300	-	-	-	-	kΩ
Offset Voltage V <sub>COIN</sub> to V <sub>DEM</sub>	V <sub>OFF</sub>	$V_I = V_{VCOIN} = \frac{V_{CC}}{2}$ Values taken over R <sub>S</sub> Range See Figure 15		4.5	-	±20	-	-	-	-	-	mV
Dynamic Output Resistance at DEMOUT	R <sub>O</sub>	$V_{DEMOUT} = \frac{V_{CC}}{2}$		4.5	-	25	-	-	-	-	-	Ω
Quiescent Device Current	I <sub>CC</sub>	V <sub>CC</sub> or GND	-	5.5	-	-	8	-	80	-	160	μA
Additional Quiescent Device Current Per Input Pin: 1 Unit Load	ΔI <sub>CC</sub> (Note 4)	V <sub>CC</sub> -2.1 (Exclud- ing Pin 5)	-	4.5 to 5.5	-	100	360	-	450	-	490	μA

**NOTES:**

- The value for R1 and R2 in parallel should exceed 2.7kΩ; R1 and R2 values above 300kΩ may contribute to frequency shift due to leakage currents.
- The maximum operating voltage can be as high as V<sub>CC</sub> -0.9V, however, this may result in an increased offset voltage.
- For dual-supply systems theoretical worst case (V<sub>I</sub> = 2.4V, V<sub>CC</sub> = 5.5V) specification is 1.8mA.

## CD74HC7046A, CD74HCT7046A

### HCT Input Loading Table

INPUT	UNIT LOADS
INH	1

NOTE: Unit Load is  $\Delta I_{CC}$  limit specified in DC Electrical Table, e.g., 360 $\mu$ A max at 25°C.

### Switching Specifications $C_L = 50\text{pF}$ , Input $t_r, t_f = 6\text{ns}$

PARAMETER	SYMBOL	TEST CONDITIONS	$V_{CC}$ (V)	25°C			-40°C TO 85°C		-55°C TO 125°C		UNITS
				MIN	TYP	MAX	MIN	MAX	MIN	MAX	
<b>HC TYPES</b>											
<b>PHASE COMPARATOR SECTION</b>											
Propagation Delay SIG <sub>IN</sub> , COMP <sub>IN</sub> to PC <sub>1OUT</sub>	$t_{PLH}, t_{PHL}$		2	-	-	200	-	250	-	300	ns
			4.5	-	-	40	-	50	-	60	ns
			6	-	-	34	-	43	-	51	ns
Output Transition Time	$t_{THL}, t_{TLH}$		2	-	-	75	-	95	-	110	ns
			4.5	-	-	15	-	19	-	22	ns
			6	-	-	13	-	16	-	19	ns
Output Enable Time, SIG <sub>IN</sub> , COMP <sub>IN</sub> to PC <sub>2OUT</sub>	$t_{PZH}, t_{PZL}$		2	-	-	280	-	350	-	420	ns
			4.5	-	-	56	-	70	-	84	ns
			6	-	-	48	-	60	-	71	ns
Output Disable Time, SIG <sub>IN</sub> , COMP <sub>IN</sub> to PC <sub>2OUT</sub>	$t_{PHZ}, t_{PLZ}$		2	-	-	325	-	405	-	490	ns
			4.5	-	-	65	-	81	-	98	ns
			6	-	-	55	-	69	-	83	ns
AC Coupled Input Sensitivity ( $\rho$ ), $\rho$ at SIG <sub>IN</sub> or COMP <sub>IN</sub>		$V_{I(P-P)}$	3	-	11	-	-	-	-	-	mV
			4.5	-	15	-	-	-	-	-	mV
			6	-	33	-	-	-	-	-	mV
<b>VCO SECTION</b>											
Frequency Stability with Temperature Change	$\frac{\Delta f}{\Delta T}$	$R_1 = 100\text{k}\Omega$ , $R_2 = \infty$	3	-	-	-	Typ 0.11		-	-	%/°C
			4.5	-	-	-	-	-	%/°C		
			6	-	-	-	-	-	%/°C		
Maximum Frequency	$f_{MAX}$	$C_1 = 50\text{pF}$ $R_1 = 3.5\text{k}\Omega$ $R_2 = \infty$	3	-	-	-	-	-	-	-	MHz
			4.5	-	24	-	-	-	-	-	MHz
			6	-	-	-	-	-	-	-	MHz
		$C_1 = 0\text{pF}$ $R_1 = 9.1\text{k}\Omega$ $R_2 = \infty$	3	-	-	-	-	-	-	-	MHz
			4.5	-	38	-	-	-	-	-	MHz
			6	-	-	-	-	-	-	-	MHz
Center Frequency	$f_0$	$C_1 = 40\text{pF}$ $R_1 = 3\text{k}\Omega$ $R_2 = \infty$ $V_{COIN} = V_{CC}/2$	3	7	10	-	-	-	-	-	MHz
			4.5	12	17	-	-	-	-	-	MHz
			6	14	21	-	-	-	-	-	MHz
Frequency Linearity	$\Delta f_{VCO}$	$R_1 = 100\text{k}\Omega$ $R_2 = \infty$ $C_1 = 100\text{pF}$	3	-	-	-	-	-	-	-	%
			4.5	-	0.4	-	-	-	-	-	%
			6	-	-	-	-	-	-	-	%

**CD74HC7046A, CD74HCT7046A**

**Switching Specifications**  $C_L = 50\text{pF}$ , Input  $t_r, t_f = 6\text{ns}$  (Continued)

PARAMETER	SYMBOL	TEST CONDITIONS	$V_{CC}$ (V)	25°C			-40°C TO 85°C		-55°C TO 125°C		UNITS
				MIN	TYP	MAX	MIN	MAX	MIN	MAX	
Offset Frequency		$R_2 = 220\text{k}\Omega$ $C_1 = 1\text{nF}$	3	-	-	-	-	-	-	-	kHz
			4.5	-	400	-	-	-	-	-	kHz
			6	-	-	-	-	-	-	-	kHz
<b>DEMODULATOR SECTION</b>											
$V_{OUT}$ vs $f_{IN}$		$R_1 = 100\text{k}\Omega$ $R_2 = \infty$ $C_1 = 100\text{pF}$ $R_5 = 10\text{k}\Omega$ $R_3 = 100\text{k}\Omega$ $C_2 = 100\text{pF}$	3	-	-	-	-	-	-	-	mV/kHz
			4.5	-	330	-	-	-	-	-	mV/kHz
			6	-	-	-	-	-	-	-	mV/kHz
<b>HCT TYPES</b>											
<b>PHASE COMPARATOR SECTION</b>											
Propagation Delay SIG <sub>IN</sub> , COMP <sub>IN</sub> to PC <sub>1OUT</sub>	$t_{PLH}, t_{PHL}$		4.5	-	-	45	-	56	-	68	ns
Output Transition Time	$t_{THL}, t_{TLH}$		4.5	-	-	15	-	19	-	22	ns
Output Enable Time, SIG <sub>IN</sub> , COMP <sub>IN</sub> to PC <sub>2OUT</sub>	$t_{PZH}, t_{PZL}$		4.5	-	-	60	-	75	-	90	ns
Output Disable Time, SIG <sub>IN</sub> , COMP <sub>IN</sub> to PC <sub>ZOUT</sub>	$t_{PHZ}, t_{PLZ}$		4.5	-	-	70	-	86	-	105	ns
AC Coupled Input Sensitivity (P-P) at SIG <sub>IN</sub> or COMP <sub>IN</sub>		$V_{I(P-P)}$	3	-	11	-	-	-	-	-	mV
			4.5	-	15	-	-	-	-	-	mV
			6	-	33	-	-	-	-	-	mV
<b>VCO SECTION</b>											
Frequency Stability with Temperature Change	$\frac{\Delta f}{\Delta T}$	$R_1 = 100\text{k}\Omega$ , $R_2 = \infty$	4.5	-	-	-	Typ 0.11		-	-	%/°C
Maximum Frequency	$f_{MAX}$	$C_1 = 50\text{pF}$ $R_1 = 3.5\text{k}\Omega$ $R_2 = \infty$	4.5	-	24	-	-	-	-	-	MHz
		$C_1 = 0\text{pF}$ $R_1 = 9.1\text{k}\Omega$ $R_2 = \infty$	4.5	-	38	-	-	-	-	-	MHz
Center Frequency	$f_0$	$C_1 = 40\text{pF}$ $R_1 = 3\text{k}\Omega$ $R_2 = \infty$ $V_{COIN} = V_{CC}/2$	4.5	12	17	-	-	-	-	-	MHz
Frequency Linearity	$\Delta f_{VCO}$	$R_1 = 100\text{k}\Omega$ $R_2 = \infty$ $C_1 = 100\text{pF}$	4.5	-	0.4	-	-	-	-	-	%
Offset Frequency		$R_2 = 220\text{k}\Omega$ $C_1 = 1\text{nF}$	4.5	-	400	-	-	-	-	-	kHz
<b>DEMODULATOR SECTION</b>											
$V_{OUT}$ vs $f_{IN}$		$R_1 = 100\text{k}\Omega$ $R_2 = \infty$ $C_1 = 100\text{pF}$ $R_5 = 10\text{k}\Omega$ $R_3 = 100\text{k}\Omega$ $C_2 = 100\text{pF}$	4.5	-	330	-	-	-	-	-	mV/kHz

Test Circuits and Waveforms

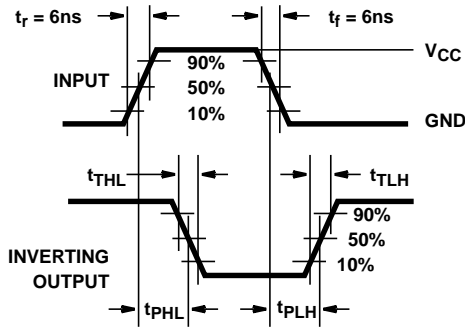

FIGURE 10. HC TRANSITION TIMES AND PROPAGATION DELAY TIMES, COMBINATION LOGIC

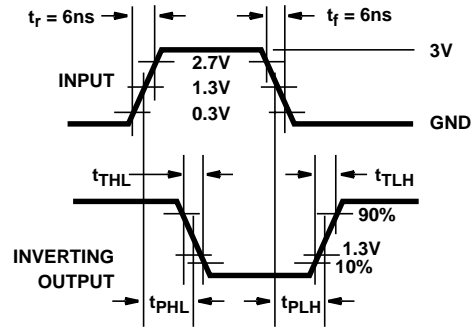

FIGURE 11. HCT TRANSITION TIMES AND PROPAGATION DELAY TIMES, COMBINATION LOGIC

Typical Performance Curves

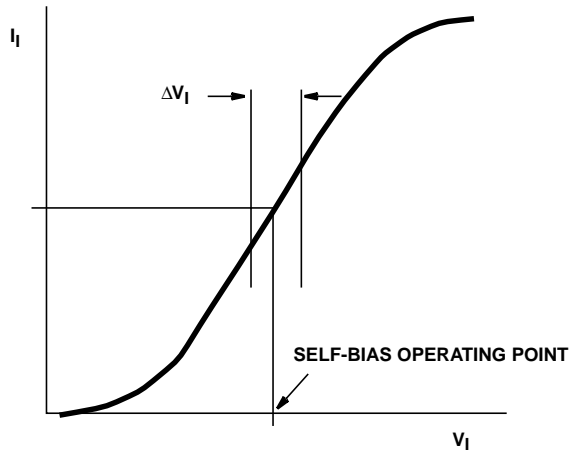

FIGURE 12. TYPICAL INPUT RESISTANCE CURVE AT SIG<sub>IN</sub>, COMP<sub>IN</sub>

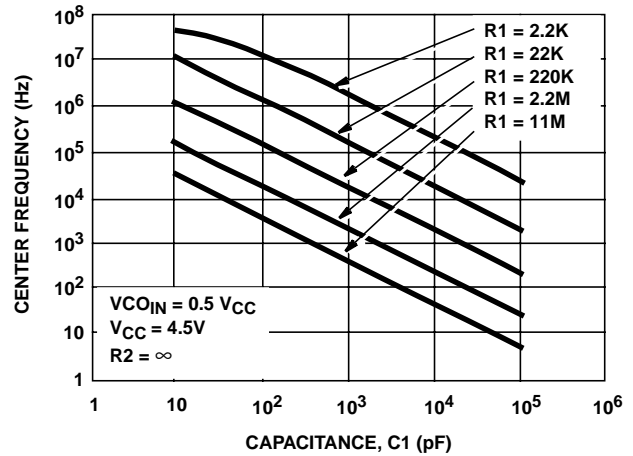

FIGURE 13. HC7046A TYPICAL CENTER FREQUENCY vs R1, C1

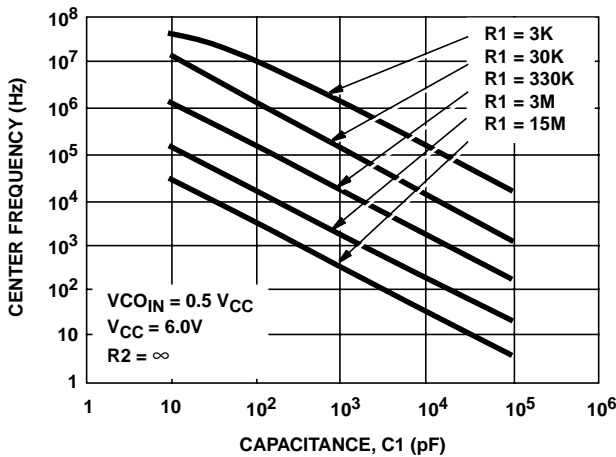

FIGURE 14. HC7046A TYPICAL CENTER FREQUENCY vs R1, C1

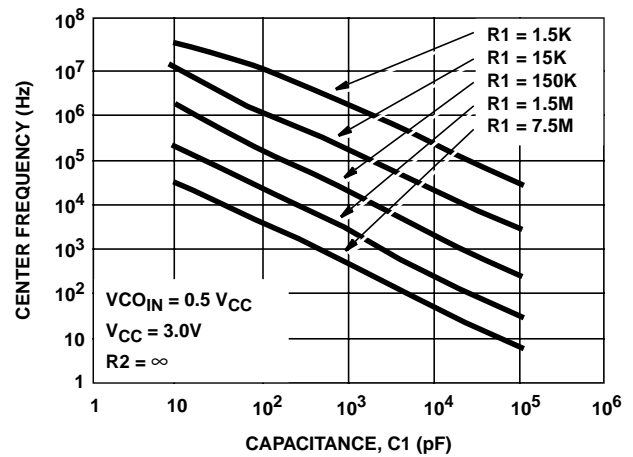

FIGURE 15. HC7046A TYPICAL CENTER FREQUENCY vs R1, C1

Typical Performance Curves (Continued)

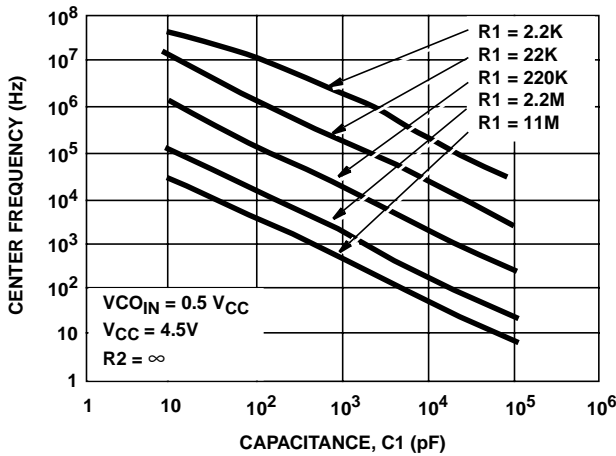

FIGURE 16. HCT7046A TYPICAL CENTER FREQUENCY vs R1, C1

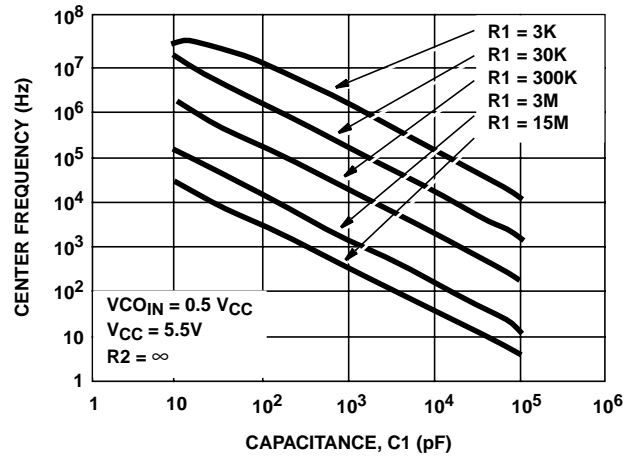

FIGURE 17. HCT7046A TYPICAL CENTER FREQUENCY vs R1, C1

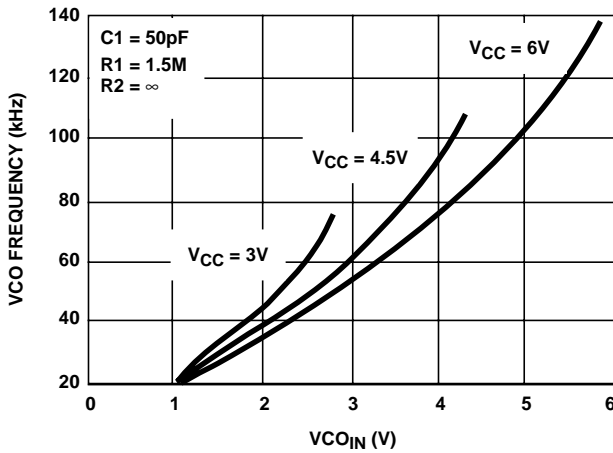

FIGURE 18. HC7046A TYPICAL VCO FREQUENCY vs VCO<sub>IN</sub>

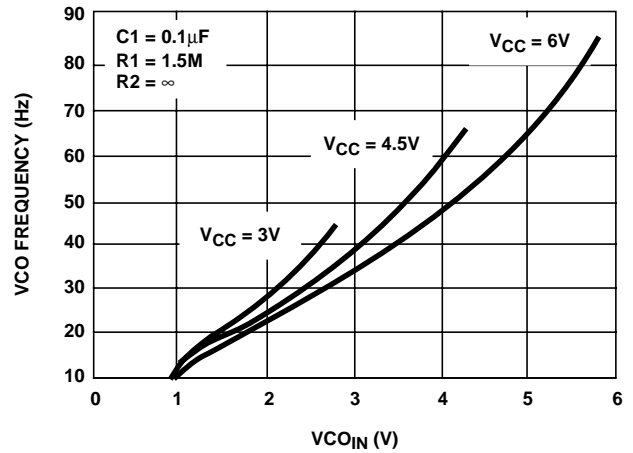

FIGURE 19. HC7046A TYPICAL VCO FREQUENCY vs VCO<sub>IN</sub>  
(R1 = 1.5MΩ, C1 = 0.1µF)

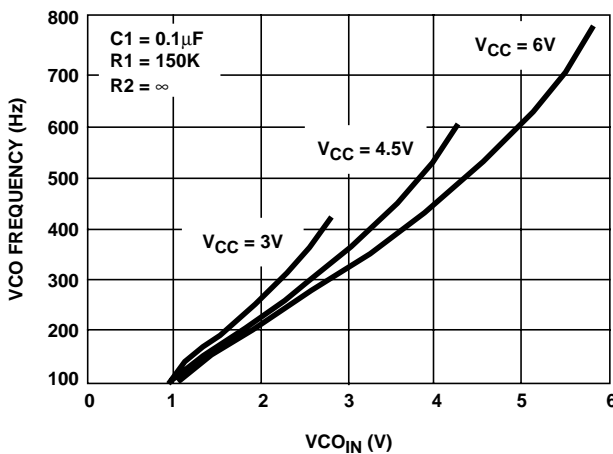

FIGURE 20. HC7046A TYPICAL VCO FREQUENCY vs VCO<sub>IN</sub>  
(R1 = 150kΩ, C1 = 0.1µF)

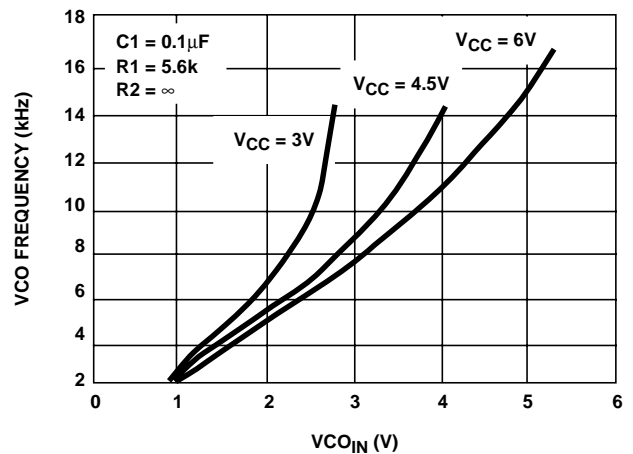

FIGURE 21. HC7046A TYPICAL VCO FREQUENCY vs VCO<sub>IN</sub>  
(R1 = 5.6kΩ, C1 = 0.1µF)

Typical Performance Curves (Continued)

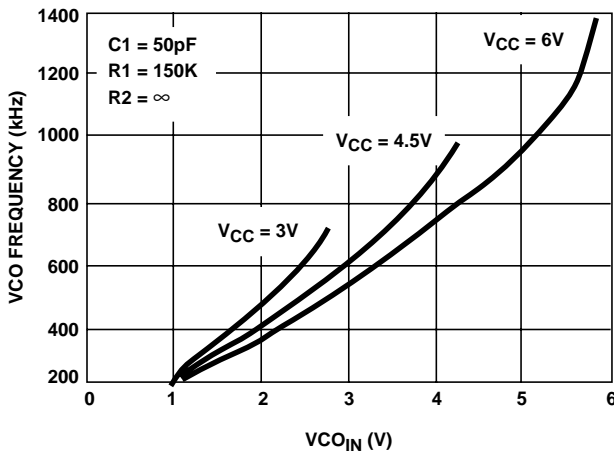

FIGURE 22. HC7046A TYPICAL VCO FREQUENCY vs VCO<sub>IN</sub> (R1 = 150kΩ, C1 = 0.1μF)

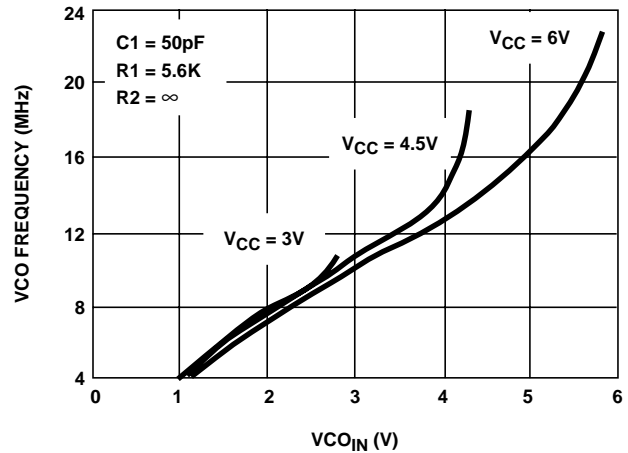

FIGURE 23. HC7046A TYPICAL VCO FREQUENCY vs VCO<sub>IN</sub> (R1 = 5.6kΩ, C1 = 50pF)

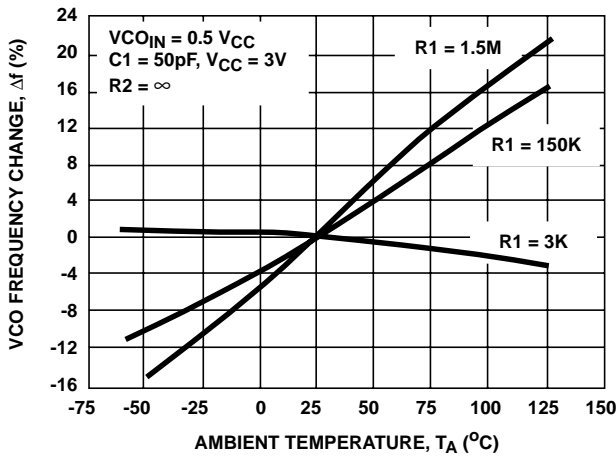

FIGURE 24. HC7046A TYPICAL CHANGE IN VCO FREQUENCY vs AMBIENT TEMPERATURE AS A FUNCTION OF R1 (V<sub>CC</sub> = 3V)

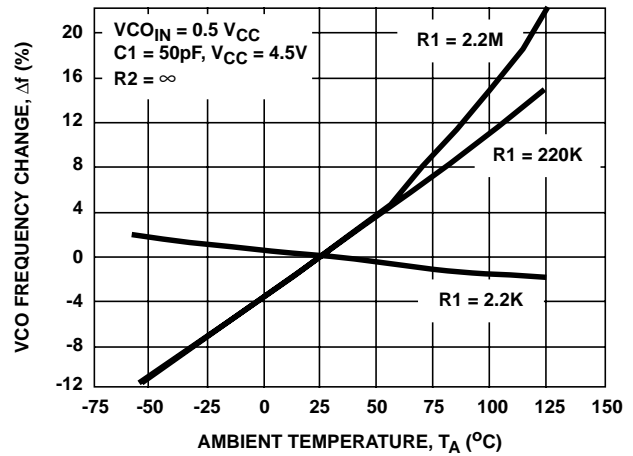

FIGURE 25. HC7046A TYPICAL CHANGE IN VCO FREQUENCY vs AMBIENT TEMPERATURE AS A FUNCTION OF R1

Typical Performance Curves (Continued)

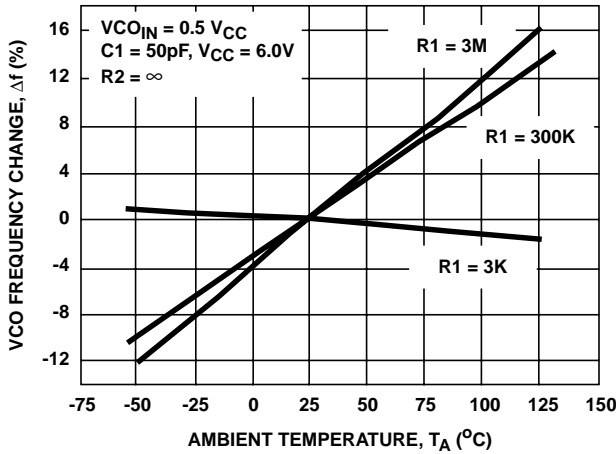

FIGURE 26. HC7046A TYPICAL CHANGE IN VCO FREQUENCY vs AMBIENT TEMPERATURE AS A FUNCTION OF R1

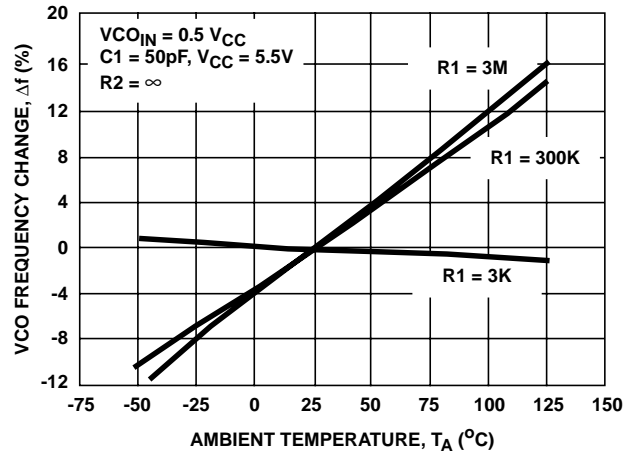

FIGURE 27. HCT7046A TYPICAL CHANGE IN VCO FREQUENCY vs AMBIENT TEMPERATURE AS A FUNCTION OF R1

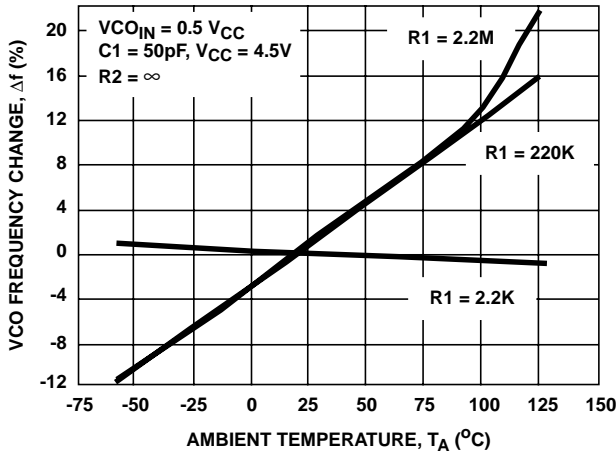

FIGURE 28. HC7046A TYPICAL CHANGE IN VCO FREQUENCY vs AMBIENT TEMPERATURE AS A FUNCTION OF R1

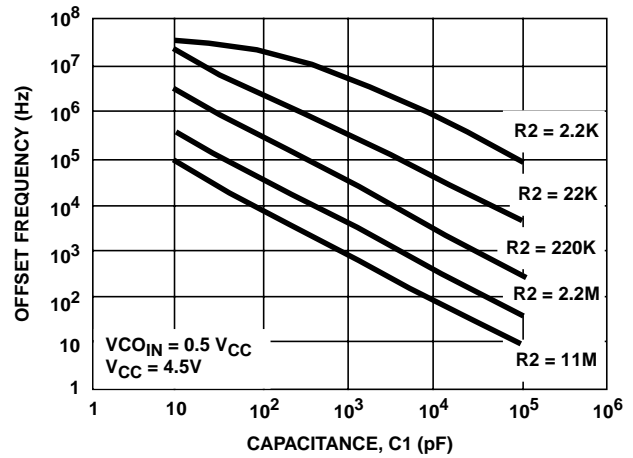

FIGURE 29. HC7046A OFFSET FREQUENCY vs R2, C1

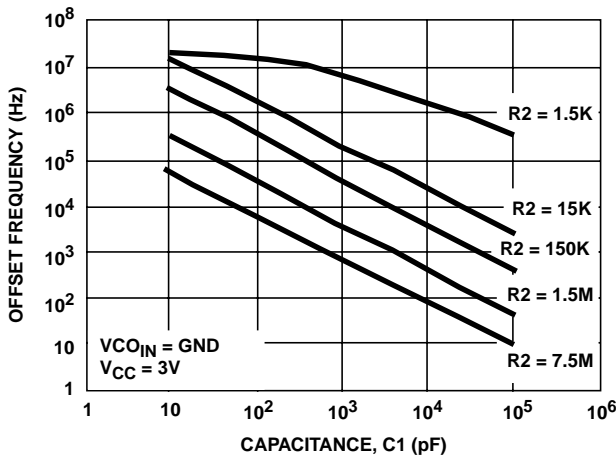

FIGURE 30. HC7046A OFFSET FREQUENCY vs R2, C1

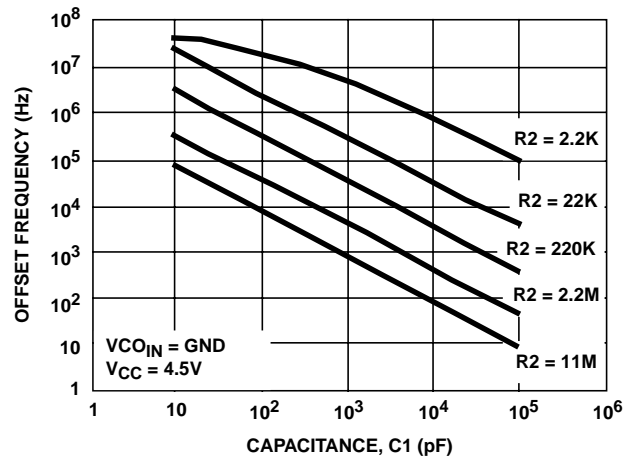

FIGURE 31. HCT7046A OFFSET FREQUENCY vs R2, C1



Typical Performance Curves (Continued)

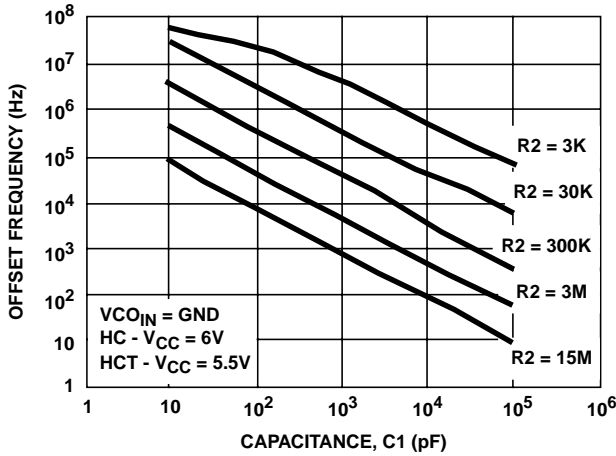

FIGURE 32. HC7046A AND HCT7046A OFFSET FREQUENCY vs R2, C1

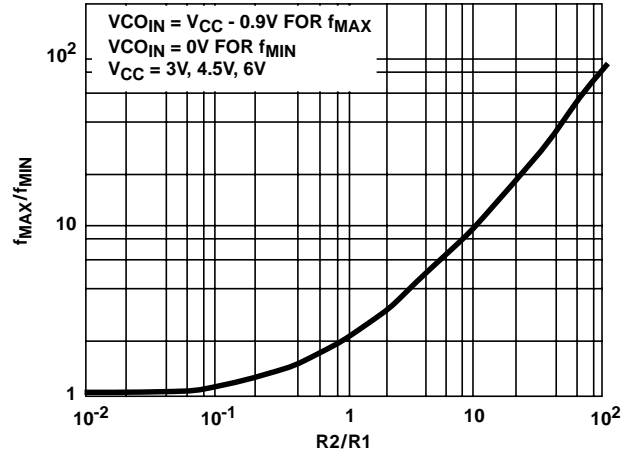

FIGURE 33. HC7046A  $f_{MAX}/f_{MIN}$  vs R2/R1

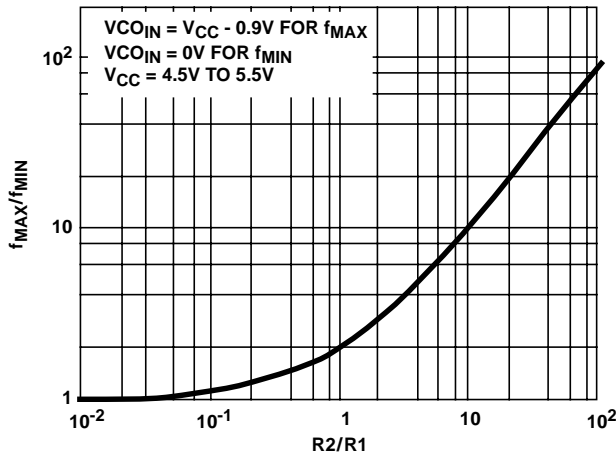

FIGURE 34. HCT7046A  $f_{MAX}/f_{MIN}$  vs R2/R1

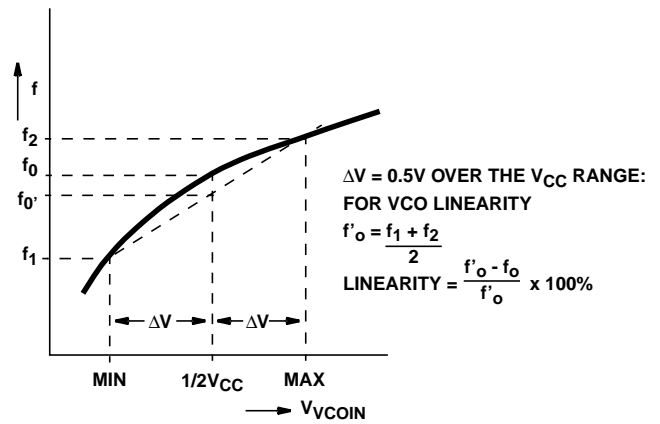

FIGURE 35. DEFINITION OF VCO FREQUENCY LINEARITY

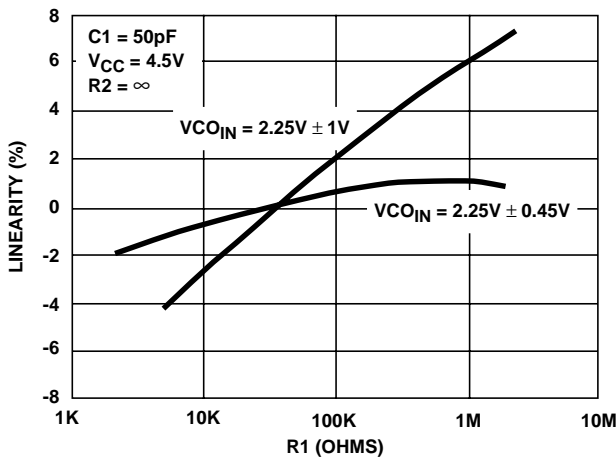

FIGURE 36. HC7046A VCO LINEARITY vs R1

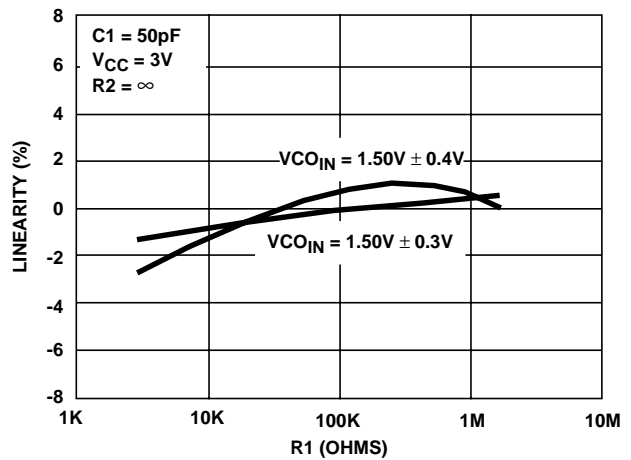

FIGURE 37. HC7046A VCO LINEARITY vs R1

Typical Performance Curves (Continued)

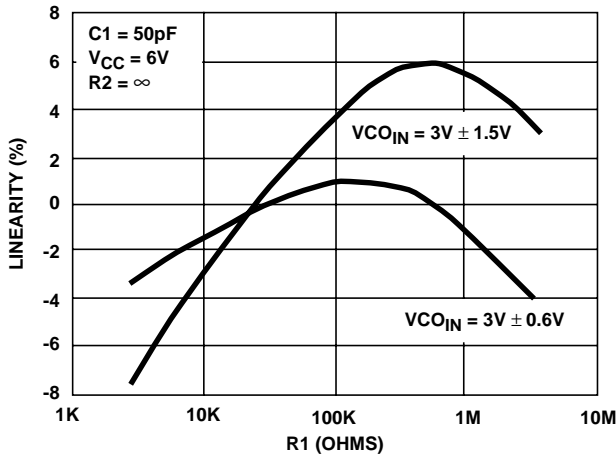

FIGURE 38. HC7046A VCO LINEARITY vs R1

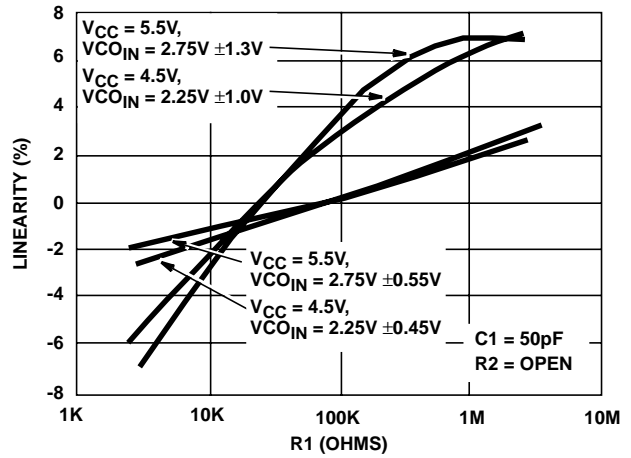

FIGURE 39. HCT7046A VCO LINEARITY vs R1

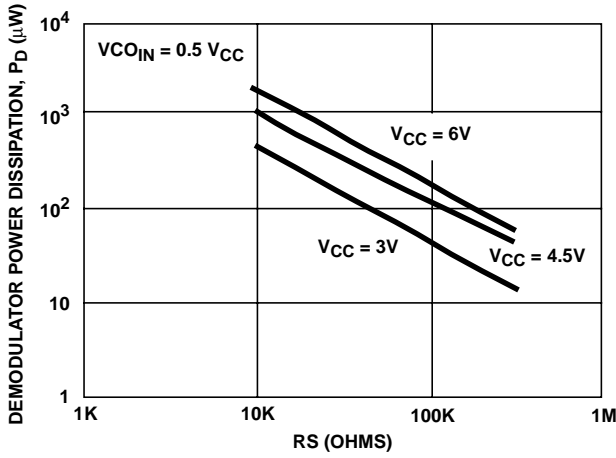

FIGURE 40. HC7046A DEMODULATOR POWER DISSIPATION vs RS (TYP)

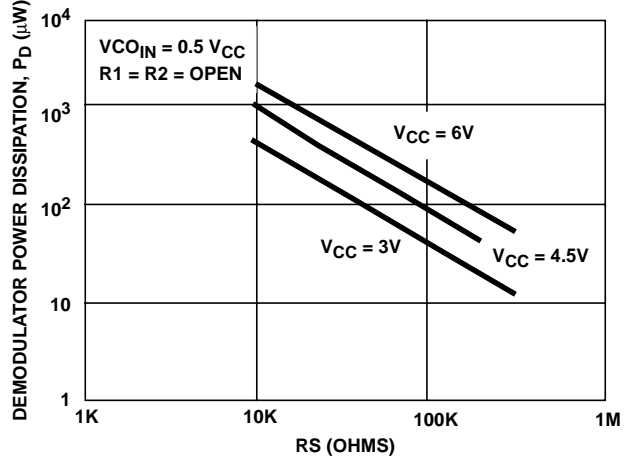

FIGURE 41. HCT7046A DEMODULATOR POWER DISSIPATION vs RS (TYP) ( $V_{CC} = 3V, 4.5V, 6V$ )

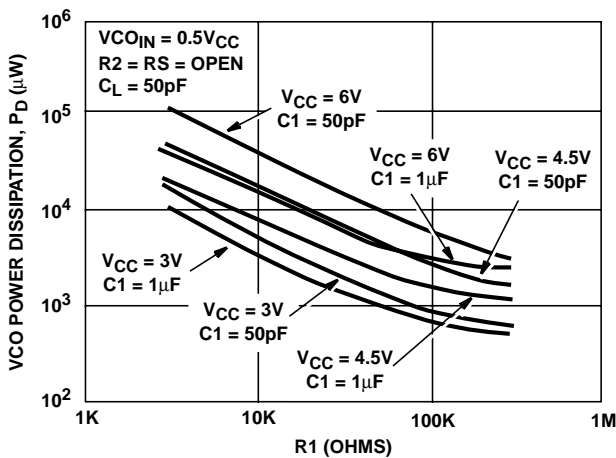

FIGURE 42. HC7046A VCO POWER DISSIPATION vs R1 ( $C1 = 50pF, 1\mu F$ )

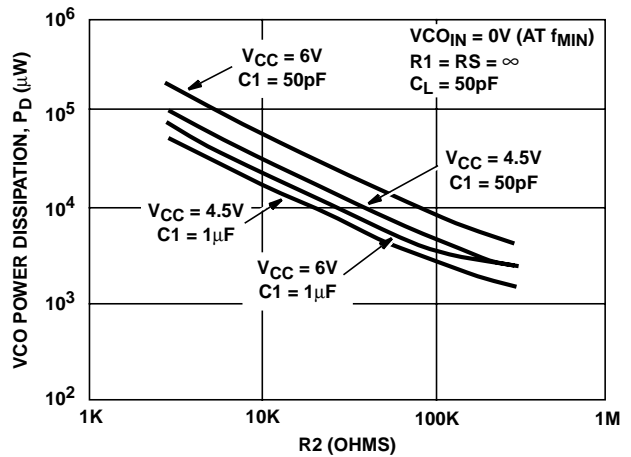

FIGURE 43. HCT7046A VCO POWER DISSIPATION vs R2 ( $C1 = 50pF, 1\mu F$ )

Typical Performance Curves (Continued)

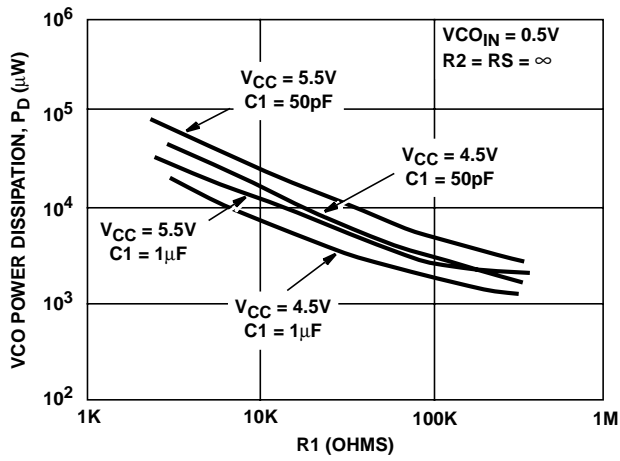

FIGURE 44. HCT7046A VCO POWER DISSIPATION vs R1 (C1 = 50pF, 1μF)

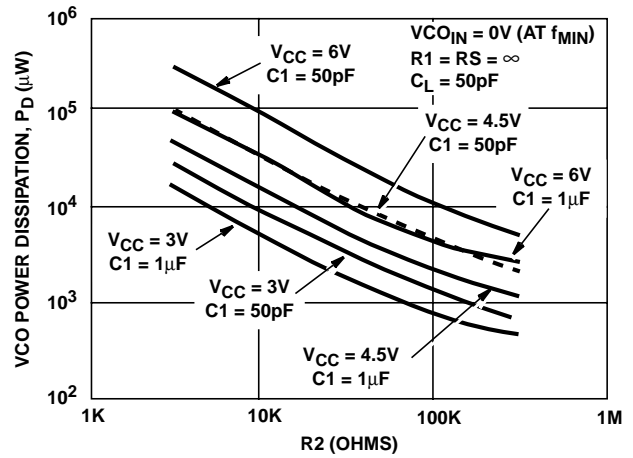

FIGURE 45. HC7046A VCO POWER DISSIPATION vs R2 (C1 = 50pF, 1μF)

## CD74HC7046A, CD74HCT7046A

### HC/HCT7046A C<sub>PD</sub>

CHIP SECTION	HC	HCT	UNIT
Comparator 1	48	50	pF
Comparator 2	39	48	pF
VCO	61	53	pF

### Application Information

This information is a guide for the approximation of values of external components to be used with the CD74HC7046A and CD74HCT7046A in a phase-lock-loop system.

References should be made to Figures 13 through 23 and Figures 36 through 41 as indicated in the table.

Values of the selected components should be within the following ranges:

- R1 > 3kΩ;
- R2 > 3kΩ;
- R1 || R2 parallel value > 2.7kΩ;
- C1 greater than 40pF

SUBJECT	PHASE COMPARATOR	DESIGN CONSIDERATIONS
VCO Frequency Without Extra Offset (R2 = ∞)	PC1 or PC2	<p>VCO Frequency Characteristic The characteristics of the VCO operation are shown in Figures 13 - 23.</p> <div style="text-align: center;"> </div> <p><b>FIGURE 46. FREQUENCY CHARACTERISTIC OF VCO OPERATING WITHOUT OFFSET: <math>f_o</math> = CENTER FREQUENCY: <math>2f_L</math> = FREQUENCY LOCK RANGE</b></p>
	PC1	<p>Selection of R1 and C1 Given <math>f_o</math>, determine the values of R1 and C1 using Figures 13 - 17.</p>
	PC2	<p>Given <math>f_{MAX}</math> calculate <math>f_o</math> as <math>f_{MAX}/2</math> and determine the values of R1 and C1 using Figures 13 - 17. To obtain <math>2f_L</math>: <math>2f_L \approx \frac{2(\Delta V_{COIN})}{R1C1}</math> where <math>0.9V &lt; V_{COIN} &lt; V_{CC} - 0.9V</math> is the range of <math>\Delta V_{COIN}</math></p>
VCO Frequency with Extra Offset (R2 > 3kΩ)	PC1 or PC2	<p>VCO Frequency Characteristic The characteristics of the VCO operation are shown in Figures 29 - 32.</p> <div style="text-align: center;"> </div> <p><b>FIGURE 47. FREQUENCY CHARACTERISTIC OF VCO OPERATING WITH OFFSET: <math>f_o</math> = CENTER FREQUENCY: <math>2f_L</math> = FREQUENCY LOCK RANGE</b></p>
	PC1 or PC2	<p>Selection of R1, R2 and C1 Given <math>f_o</math> and <math>f_L</math>, offset frequency, <math>f_{MIN}</math>, may be calculated from <math>f_{MIN} \approx f_o - 1.6 f_L</math>. Obtain the values of C1 and R2 by using Figures 29 - 32. Calculate the values of R1 from Figures 33 - 34.</p>

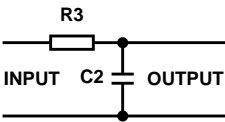
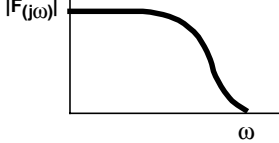
SUBJECT	PHASE COMPARATOR	DESIGN CONSIDERATIONS
PLL Conditions with No Signal at the SIG <sub>IN</sub> Input	PC1	VCO adjusts to $f_o$ with $\phi_{\text{DEMOUT}} = 90^\circ$ and $V_{\text{VCOIN}} = 1/2 V_{\text{CC}}$ (see Figure 2)
	PC2	VCO adjusts to $f_{\text{MIN}}$ with $\phi_{\text{DEMOUT}} = -360^\circ$ and $V_{\text{VCOIN}} = 0V$ (see Figure 4)
PLL Frequency Capture Range	PC1 or PC2	Loop Filter Component Selection  <p>(A) <math>\tau_1 = R_3 \times C_2</math>      (B) AMPLITUDE CHARACTERISTIC      (C) POLE-ZERO DIAGRAM</p> <p>A small capture range (<math>2f_c</math>) is obtained if <math>\tau &gt; 2f_c \approx (1/\pi) (2\pi f_L / \tau_1)^{1/2}</math></p> <p><b>FIGURE 48. SIMPLE LOOP FILTER FOR PLL WITHOUT OFFSET</b></p>
		 <p>(A) <math>\tau_2 = R_4 \times C_2</math>; <math>\tau_3 = (R_3 + R_4) \times C_2</math>      (B) AMPLITUDE CHARACTERISTIC      (C) POLE-ZERO DIAGRAM</p> <p><b>FIGURE 49. SIMPLE LOOP FILTER FOR PLL WITH OFFSET</b></p>
PLL Locks on Harmonics at Center Frequency	PC1	Yes
	PC2	No
Noise Rejection at Signal Input	PC1	High
	PC2	Low
AC Ripple Content when PLL is Locked	PC1	$f_r = 2f_i$ , large ripple content at $\phi_{\text{DEMOUT}} = 90^\circ$
	PC2	$f_r = f_i$ , small ripple content at $\phi_{\text{DEMOUT}} = 0^\circ$

### Lock Detector Circuit

The lock detector feature is very useful in data synchronization, motor speed control, and demodulation. By adjusting the value of the lock detector capacitor so that the lock output will change slightly before actually losing lock, the designer can create an “early warning” indication allowing corrective measures to be implemented. The reverse is also true, especially with motor speed controls, generators, and clutches that must be set up before actual lock occurs or disconnected during loss of lock.

When using phase comparator 1, the detector will only indicate a lock condition on the fundamental frequency and not on the harmonics, which PC1 will lock on.

**PACKAGING INFORMATION**

Orderable Device	Status <sup>(1)</sup>	Package Type	Package Drawing	Pins	Package Qty	Eco Plan <sup>(2)</sup>	Lead/Ball Finish	MSL Peak Temp <sup>(3)</sup>
CD74HC7046AE	ACTIVE	PDIP	N	16	25	Pb-Free (RoHS)	CU NIPDAU	N / A for Pkg Type
CD74HC7046AEE4	ACTIVE	PDIP	N	16	25	Pb-Free (RoHS)	CU NIPDAU	N / A for Pkg Type
CD74HC7046AM	ACTIVE	SOIC	D	16	40	Green (RoHS & no Sb/Br)	CU NIPDAU	Level-1-260C-UNLIM
CD74HC7046AM96	ACTIVE	SOIC	D	16	2500	Green (RoHS & no Sb/Br)	CU NIPDAU	Level-1-260C-UNLIM
CD74HC7046AM96E4	ACTIVE	SOIC	D	16	2500	Green (RoHS & no Sb/Br)	CU NIPDAU	Level-1-260C-UNLIM
CD74HC7046AM96G4	ACTIVE	SOIC	D	16	2500	Green (RoHS & no Sb/Br)	CU NIPDAU	Level-1-260C-UNLIM
CD74HC7046AME4	ACTIVE	SOIC	D	16	40	Green (RoHS & no Sb/Br)	CU NIPDAU	Level-1-260C-UNLIM
CD74HC7046AMG4	ACTIVE	SOIC	D	16	40	Green (RoHS & no Sb/Br)	CU NIPDAU	Level-1-260C-UNLIM
CD74HC7046AMT	ACTIVE	SOIC	D	16	250	Green (RoHS & no Sb/Br)	CU NIPDAU	Level-1-260C-UNLIM
CD74HC7046AMTE4	ACTIVE	SOIC	D	16	250	Green (RoHS & no Sb/Br)	CU NIPDAU	Level-1-260C-UNLIM
CD74HC7046AMTG4	ACTIVE	SOIC	D	16	250	Green (RoHS & no Sb/Br)	CU NIPDAU	Level-1-260C-UNLIM
CD74HCT7046AE	ACTIVE	PDIP	N	16	25	Pb-Free (RoHS)	CU NIPDAU	N / A for Pkg Type
CD74HCT7046AEE4	ACTIVE	PDIP	N	16	25	Pb-Free (RoHS)	CU NIPDAU	N / A for Pkg Type
CD74HCT7046AM	ACTIVE	SOIC	D	16	40	Green (RoHS & no Sb/Br)	CU NIPDAU	Level-1-260C-UNLIM
CD74HCT7046AM96	ACTIVE	SOIC	D	16	2500	Green (RoHS & no Sb/Br)	CU NIPDAU	Level-1-260C-UNLIM
CD74HCT7046AM96E4	ACTIVE	SOIC	D	16	2500	Green (RoHS & no Sb/Br)	CU NIPDAU	Level-1-260C-UNLIM
CD74HCT7046AM96G4	ACTIVE	SOIC	D	16	2500	Green (RoHS & no Sb/Br)	CU NIPDAU	Level-1-260C-UNLIM
CD74HCT7046AME4	ACTIVE	SOIC	D	16	40	Green (RoHS & no Sb/Br)	CU NIPDAU	Level-1-260C-UNLIM
CD74HCT7046AMG4	ACTIVE	SOIC	D	16	40	Green (RoHS & no Sb/Br)	CU NIPDAU	Level-1-260C-UNLIM
CD74HCT7046AMT	ACTIVE	SOIC	D	16	250	Green (RoHS & no Sb/Br)	CU NIPDAU	Level-1-260C-UNLIM
CD74HCT7046AMTE4	ACTIVE	SOIC	D	16	250	Green (RoHS & no Sb/Br)	CU NIPDAU	Level-1-260C-UNLIM
CD74HCT7046AMTG4	ACTIVE	SOIC	D	16	250	Green (RoHS & no Sb/Br)	CU NIPDAU	Level-1-260C-UNLIM

<sup>(1)</sup> The marketing status values are defined as follows:

**ACTIVE:** Product device recommended for new designs.

**LIFEBUY:** TI has announced that the device will be discontinued, and a lifetime-buy period is in effect.

**NRND:** Not recommended for new designs. Device is in production to support existing customers, but TI does not recommend using this part in a new design.

**PREVIEW:** Device has been announced but is not in production. Samples may or may not be available.

---

**OBSOLETE:** TI has discontinued the production of the device.

<sup>(2)</sup> Eco Plan - The planned eco-friendly classification: Pb-Free (RoHS), Pb-Free (RoHS Exempt), or Green (RoHS & no Sb/Br) - please check <http://www.ti.com/productcontent> for the latest availability information and additional product content details.

**TBD:** The Pb-Free/Green conversion plan has not been defined.

**Pb-Free (RoHS):** TI's terms "Lead-Free" or "Pb-Free" mean semiconductor products that are compatible with the current RoHS requirements for all 6 substances, including the requirement that lead not exceed 0.1% by weight in homogeneous materials. Where designed to be soldered at high temperatures, TI Pb-Free products are suitable for use in specified lead-free processes.

**Pb-Free (RoHS Exempt):** This component has a RoHS exemption for either 1) lead-based flip-chip solder bumps used between the die and package, or 2) lead-based die adhesive used between the die and leadframe. The component is otherwise considered Pb-Free (RoHS compatible) as defined above.

**Green (RoHS & no Sb/Br):** TI defines "Green" to mean Pb-Free (RoHS compatible), and free of Bromine (Br) and Antimony (Sb) based flame retardants (Br or Sb do not exceed 0.1% by weight in homogeneous material)

<sup>(3)</sup> MSL, Peak Temp. -- The Moisture Sensitivity Level rating according to the JEDEC industry standard classifications, and peak solder temperature.

**Important Information and Disclaimer:**The information provided on this page represents TI's knowledge and belief as of the date that it is provided. TI bases its knowledge and belief on information provided by third parties, and makes no representation or warranty as to the accuracy of such information. Efforts are underway to better integrate information from third parties. TI has taken and continues to take reasonable steps to provide representative and accurate information but may not have conducted destructive testing or chemical analysis on incoming materials and chemicals. TI and TI suppliers consider certain information to be proprietary, and thus CAS numbers and other limited information may not be available for release.

In no event shall TI's liability arising out of such information exceed the total purchase price of the TI part(s) at issue in this document sold by TI to Customer on an annual basis.

**TAPE AND REEL INFORMATION**



**QUADRANT ASSIGNMENTS FOR PIN 1 ORIENTATION IN TAPE**



\*All dimensions are nominal

Device	Package Type	Package Drawing	Pins	SPQ	Reel Diameter (mm)	Reel Width W1 (mm)	A0 (mm)	B0 (mm)	K0 (mm)	P1 (mm)	W (mm)	Pin1 Quadrant
CD74HC7046AM96	SOIC	D	16	2500	330.0	16.4	6.5	10.3	2.1	8.0	16.0	Q1
CD74HCT7046AM96	SOIC	D	16	2500	330.0	16.4	6.5	10.3	2.1	8.0	16.0	Q1



**TAPE AND REEL BOX DIMENSIONS**



\*All dimensions are nominal

Device	Package Type	Package Drawing	Pins	SPQ	Length (mm)	Width (mm)	Height (mm)
CD74HC7046AM96	SOIC	D	16	2500	333.2	345.9	28.6
CD74HCT7046AM96	SOIC	D	16	2500	333.2	345.9	28.6

D (R-PDSO-G16)

PLASTIC SMALL-OUTLINE PACKAGE

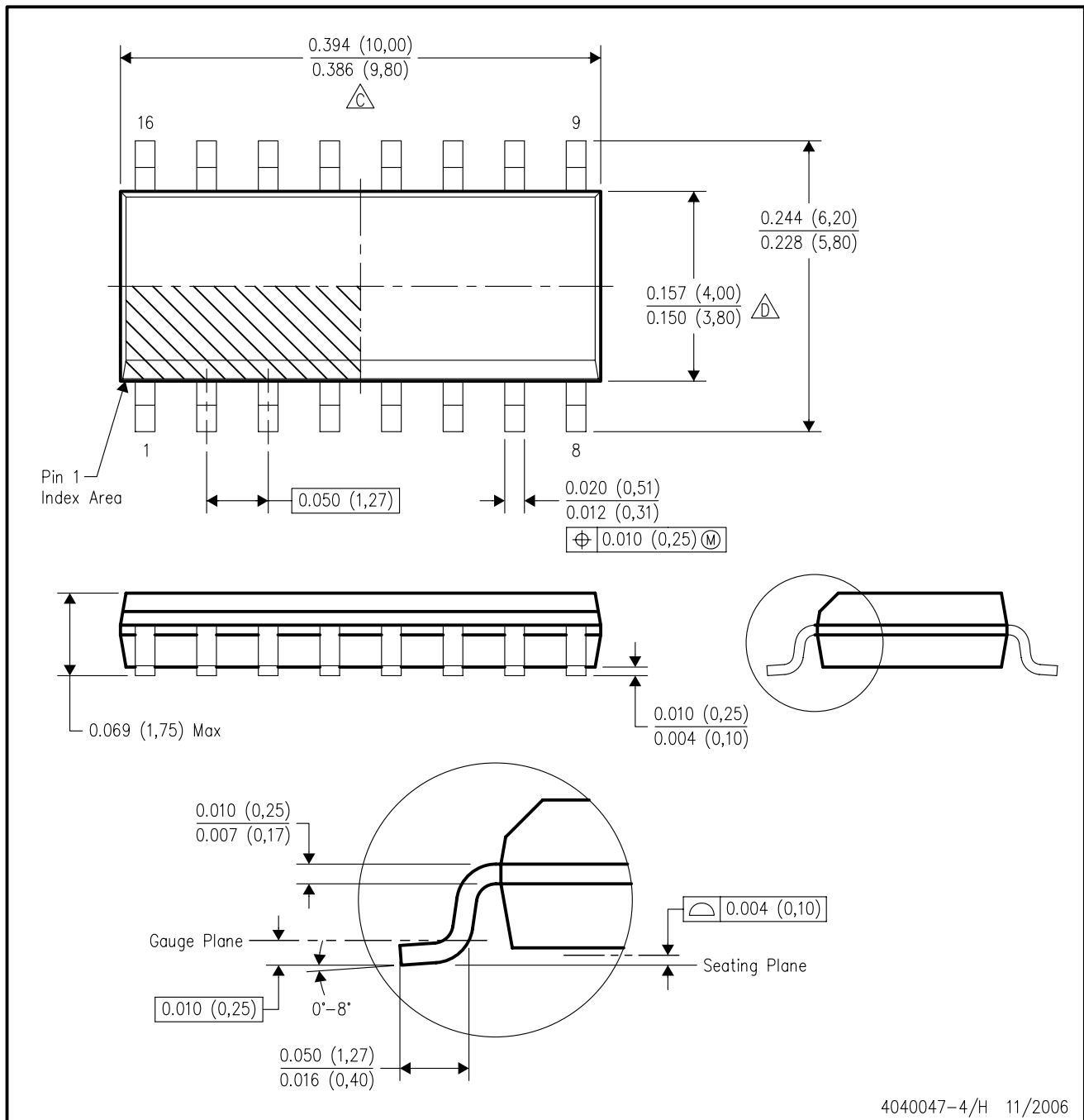

- NOTES:
- A. All linear dimensions are in inches (millimeters).
  - B. This drawing is subject to change without notice.
  - C. Body length does not include mold flash, protrusions, or gate burrs. Mold flash, protrusions, or gate burrs shall not exceed .006 (0,15) per end.
  - D. Body width does not include interlead flash. Interlead flash shall not exceed .017 (0,43) per side.
  - E. Reference JEDEC MS-012 variation AC.

N (R-PDIP-T\*\*)

PLASTIC DUAL-IN-LINE PACKAGE

16 PINS SHOWN



- NOTES:
- A. All linear dimensions are in inches (millimeters).
  - B. This drawing is subject to change without notice.
  - $\triangle C$  Falls within JEDEC MS-001, except 18 and 20 pin minimum body length (Dim A).
  - $\triangle D$  The 20 pin end lead shoulder width is a vendor option, either half or full width.

4040049/E 12/2002

## IMPORTANT NOTICE

Texas Instruments Incorporated and its subsidiaries (TI) reserve the right to make corrections, modifications, enhancements, improvements, and other changes to its products and services at any time and to discontinue any product or service without notice. Customers should obtain the latest relevant information before placing orders and should verify that such information is current and complete. All products are sold subject to TI's terms and conditions of sale supplied at the time of order acknowledgment.

TI warrants performance of its hardware products to the specifications applicable at the time of sale in accordance with TI's standard warranty. Testing and other quality control techniques are used to the extent TI deems necessary to support this warranty. Except where mandated by government requirements, testing of all parameters of each product is not necessarily performed.

TI assumes no liability for applications assistance or customer product design. Customers are responsible for their products and applications using TI components. To minimize the risks associated with customer products and applications, customers should provide adequate design and operating safeguards.

TI does not warrant or represent that any license, either express or implied, is granted under any TI patent right, copyright, mask work right, or other TI intellectual property right relating to any combination, machine, or process in which TI products or services are used. Information published by TI regarding third-party products or services does not constitute a license from TI to use such products or services or a warranty or endorsement thereof. Use of such information may require a license from a third party under the patents or other intellectual property of the third party, or a license from TI under the patents or other intellectual property of TI.

Reproduction of TI information in TI data books or data sheets is permissible only if reproduction is without alteration and is accompanied by all associated warranties, conditions, limitations, and notices. Reproduction of this information with alteration is an unfair and deceptive business practice. TI is not responsible or liable for such altered documentation. Information of third parties may be subject to additional restrictions.

Resale of TI products or services with statements different from or beyond the parameters stated by TI for that product or service voids all express and any implied warranties for the associated TI product or service and is an unfair and deceptive business practice. TI is not responsible or liable for any such statements.

TI products are not authorized for use in safety-critical applications (such as life support) where a failure of the TI product would reasonably be expected to cause severe personal injury or death, unless officers of the parties have executed an agreement specifically governing such use. Buyers represent that they have all necessary expertise in the safety and regulatory ramifications of their applications, and acknowledge and agree that they are solely responsible for all legal, regulatory and safety-related requirements concerning their products and any use of TI products in such safety-critical applications, notwithstanding any applications-related information or support that may be provided by TI. Further, Buyers must fully indemnify TI and its representatives against any damages arising out of the use of TI products in such safety-critical applications.

TI products are neither designed nor intended for use in military/aerospace applications or environments unless the TI products are specifically designated by TI as military-grade or "enhanced plastic." Only products designated by TI as military-grade meet military specifications. Buyers acknowledge and agree that any such use of TI products which TI has not designated as military-grade is solely at the Buyer's risk, and that they are solely responsible for compliance with all legal and regulatory requirements in connection with such use.

TI products are neither designed nor intended for use in automotive applications or environments unless the specific TI products are designated by TI as compliant with ISO/TS 16949 requirements. Buyers acknowledge and agree that, if they use any non-designated products in automotive applications, TI will not be responsible for any failure to meet such requirements.

Following are URLs where you can obtain information on other Texas Instruments products and application solutions:

### Products

Amplifiers	<a href="http://amplifier.ti.com">amplifier.ti.com</a>
Data Converters	<a href="http://dataconverter.ti.com">dataconverter.ti.com</a>
DSP	<a href="http://dsp.ti.com">dsp.ti.com</a>
Clocks and Timers	<a href="http://www.ti.com/clocks">www.ti.com/clocks</a>
Interface	<a href="http://interface.ti.com">interface.ti.com</a>
Logic	<a href="http://logic.ti.com">logic.ti.com</a>
Power Mgmt	<a href="http://power.ti.com">power.ti.com</a>
Microcontrollers	<a href="http://microcontroller.ti.com">microcontroller.ti.com</a>
RFID	<a href="http://www.ti-rfid.com">www.ti-rfid.com</a>
RF/IF and ZigBee® Solutions	<a href="http://www.ti.com/lprf">www.ti.com/lprf</a>

### Applications

Audio	<a href="http://www.ti.com/audio">www.ti.com/audio</a>
Automotive	<a href="http://www.ti.com/automotive">www.ti.com/automotive</a>
Broadband	<a href="http://www.ti.com/broadband">www.ti.com/broadband</a>
Digital Control	<a href="http://www.ti.com/digitalcontrol">www.ti.com/digitalcontrol</a>
Medical	<a href="http://www.ti.com/medical">www.ti.com/medical</a>
Military	<a href="http://www.ti.com/military">www.ti.com/military</a>
Optical Networking	<a href="http://www.ti.com/opticalnetwork">www.ti.com/opticalnetwork</a>
Security	<a href="http://www.ti.com/security">www.ti.com/security</a>
Telephony	<a href="http://www.ti.com/telephony">www.ti.com/telephony</a>
Video & Imaging	<a href="http://www.ti.com/video">www.ti.com/video</a>
Wireless	<a href="http://www.ti.com/wireless">www.ti.com/wireless</a>

Mailing Address: Texas Instruments, Post Office Box 655303, Dallas, Texas 75265  
Copyright © 2008, Texas Instruments Incorporated