

CEP62A3/CEB62A3

Feb. 2003

N-Channel Logic Level Enhancement Mode Field Effect Transistor

4

FEATURES

- 30V , 60A , $R_{DS(ON)}=10m\Omega$ @ $V_{GS}=10V$.
 $R_{DS(ON)}=15m\Omega$ @ $V_{GS}=4.5V$.
- Super high dense cell design for extremely low $R_{DS(ON)}$.
- High power and current handling capability.
- TO-220 & TO-263 package.

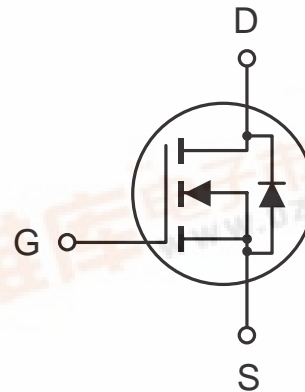

ABSOLUTE MAXIMUM RATINGS (Tc=25°C unless otherwise noted)

Parameter	Symbol	Limit	Unit
Drain-Source Voltage	V _{DS}	30	V
Gate-Source Voltage	V _{GS}	±20	V
Drain Current-Continuous -Pulsed	I _D	60	A
	I _{DM}	180	A
Drain-Source Diode Forward Current	I _S	60	A
Maximum Power Dissipation @T _c =25°C Derate above 25°C	P _D	68	W
		0.45	W/°C
Operating and Storage Temperature Range	T _J , T _{STG}	-55 to 175	°C

THERMAL CHARACTERISTICS

Thermal Resistance, Junction-to-Case	R _{θJC}	2.2	°C/W
Thermal Resistance, Junction-to-Ambient	R _{θJA}	62.5	°C/W



CEP62A3/CEB62A3

ELECTRICAL CHARACTERISTICS (T_c=25°C unless otherwise noted)

4

Parameter	Symbol	Condition	Min	Typ	Max	Unit
OFF CHARACTERISTICS						
Drain-Source Breakdown Voltage	BV _{DSS}	V _{GS} = 0V, I _D = 250μA	30			V
Zero Gate Voltage Drain Current	I _{DSS}	V _{DS} = 30V, V _{GS} = 0V			1	μA
Gate-Body Leakage	I _{GSS}	V _{GS} = ±20V, V _{DS} = 0V			±100	nA
ON CHARACTERISTICS^a						
Gate Threshold Voltage	V _{GS(th)}	V _{DS} = V _{GS} , I _D = 250μA	1		3	V
Drain-Source On-State Resistance	R _{DS(ON)}	V _{GS} = 10V, I _D = 26A		8.5	10	mΩ
		V _{GS} = 4.5V, I _D = 21A		12	15	mΩ
On-State Drain Current	I _{D(ON)}	V _{GS} = 10V, V _{DS} = 5V	60			A
Forward Transconductance	g _{FS}	V _{DS} = 10V, I _D = 26A		36		S
DYNAMIC CHARACTERISTICS^b						
Input Capacitance	C _{ISS}	V _{DS} = 15V, V _{GS} = 0V f = 1.0MHz		1100		pF
Output Capacitance	C _{OSS}			600		pF
Reverse Transfer Capacitance	C _{RSS}			180		pF
SWITCHING CHARACTERISTICS^b						
Turn-On Delay Time	t _{D(ON)}	V _{DD} = 15V, I _D = 60A, V _{GEN} = 10V R _G = 24Ω		19	48	ns
Rise Time	t _r			36	72	ns
Turn-Off Delay Time	t _{D(OFF)}			97	175	ns
Fall Time	t _f			68	135	ns
Total Gate Charge	Q _g	V _{DS} = 15V, I _D = 30A, V _{GS} = 10V		35	42	nC
Gate-Source Charge	Q _{gs}			6		nC
Gate-Drain Charge	Q _{gd}			11		nC

CEP62A3/CEB62A3

ELECTRICAL CHARACTERISTICS ($T_c=25^\circ\text{C}$ unless otherwise noted)

4

Parameter	Symbol	Condition	Min	Typ	Max	Unit
DRAIN-SOURCE DIODE CHARACTERISTICS ^a						
Diode Forward Voltage	V_{SD}	$V_{GS} = 0V, I_s = 26A$			1.3	V

Notes

- a. Pulse Test: Pulse Width $\leq 300 \mu s$, Duty Cycle $\leq 2\%$.
- b. Guaranteed by design, not subject to production testing.

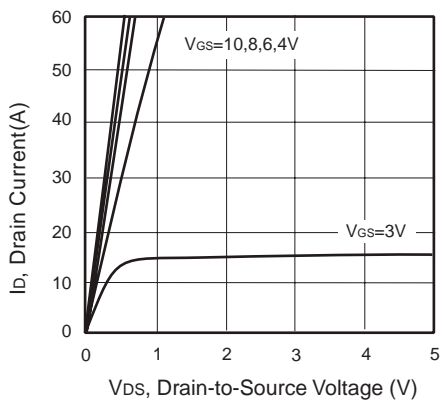

Figure 1. Output Characteristics

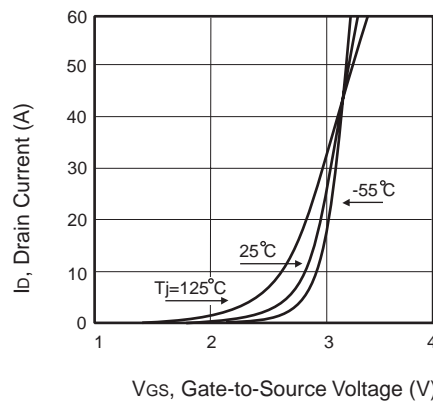

Figure 2. Transfer Characteristics

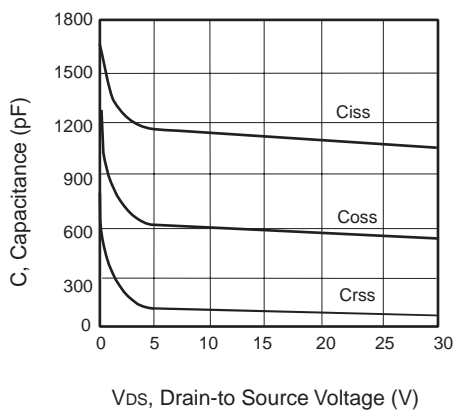

Figure 3. Capacitance

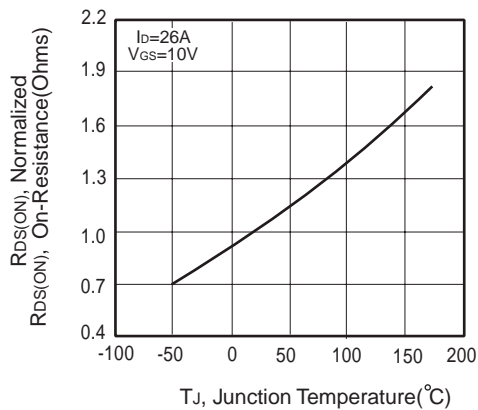

Figure 4. On-Resistance Variation with Temperature

CEP62A3/CEB62A3

4

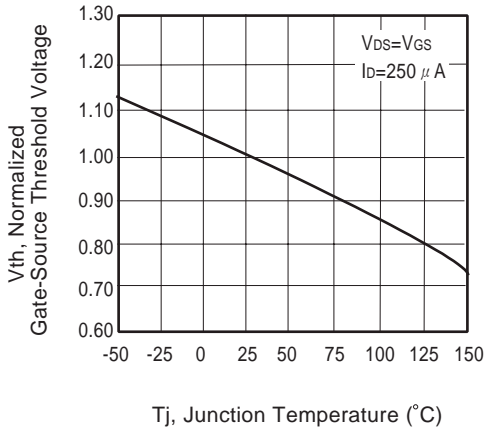

Figure 5. Gate Threshold Variation with Temperature

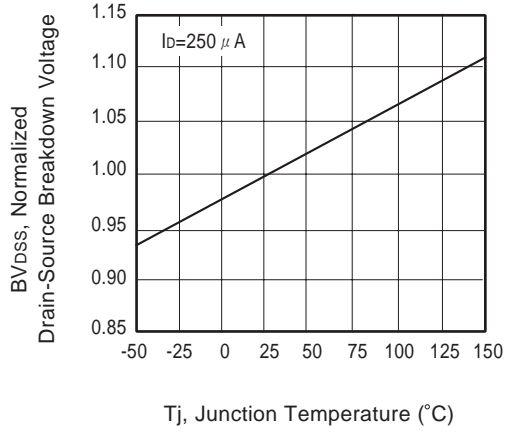

Figure 6. Breakdown Voltage Variation with Temperature

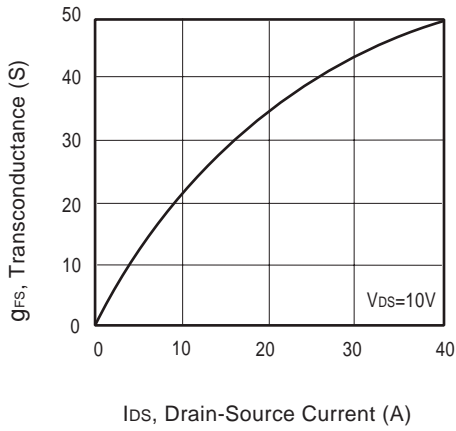

Figure 7. Transconductance Variation with Drain Current

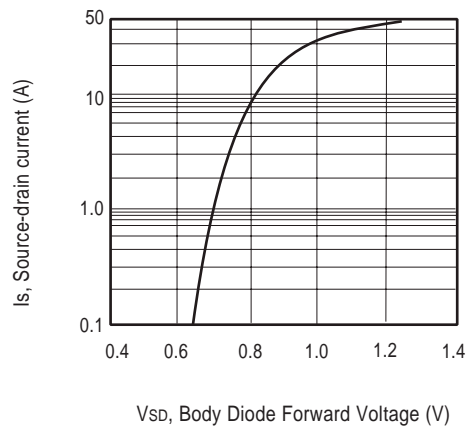

Figure 8. Body Diode Forward Voltage Variation with Source Current

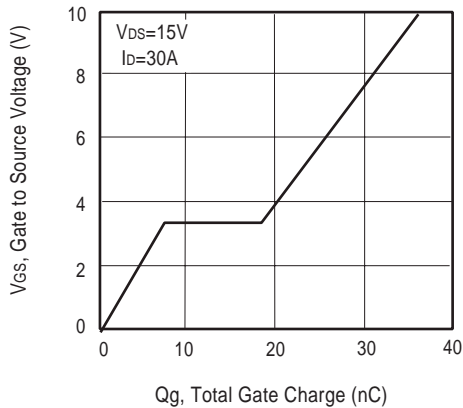

Figure 9. Gate Charge

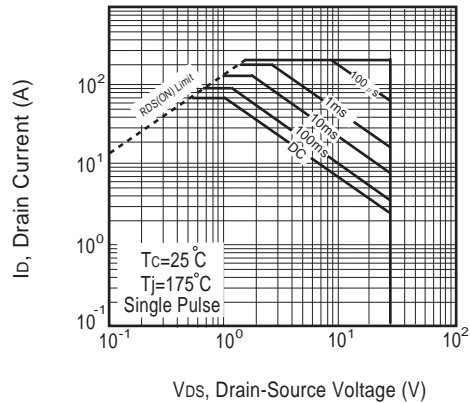

Figure 10. Maximum Safe Operating Area

CEP62A3/CEB62A3

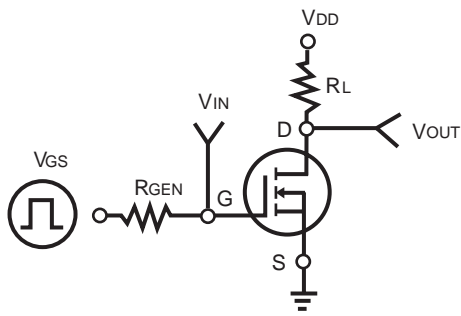

Figure 11. Switching Test Circuit

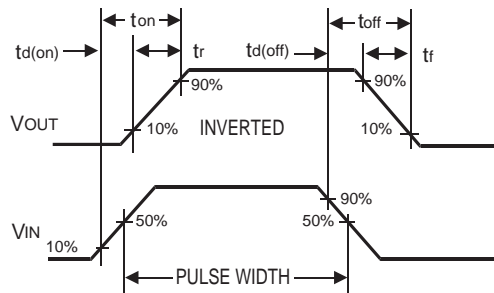

Figure 12. Switching Waveforms

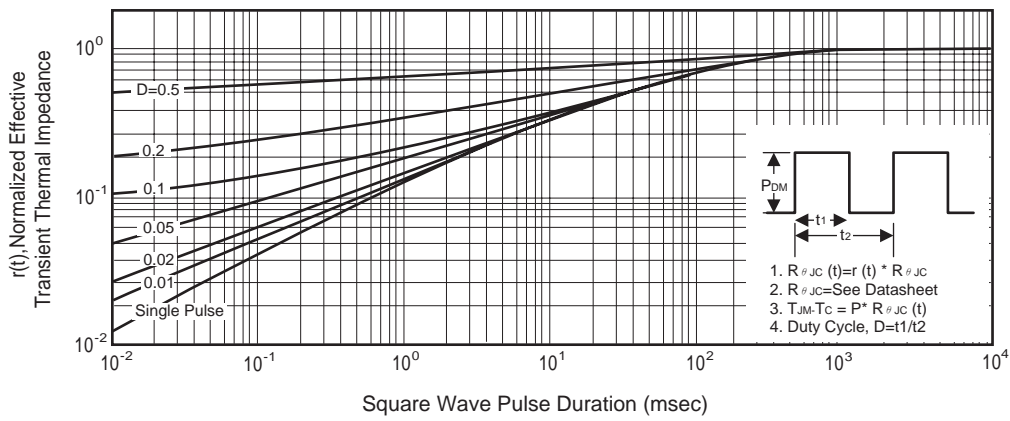

Figure 13. Normalized Thermal Transient Impedance Curve