

CEP7060L/CEB7060L



March 1998

4

N-Channel Logic Level Enhancement Mode Field Effect

FEATURES

- 60V , 75A , $R_{DS(ON)}=14m\Omega$ @ $V_{GS}=5V$.
- Super high dense cell design for extremely low $R_{DS(ON)}$.
- High power and current handling capability.
- TO-220 & TO-263 package.

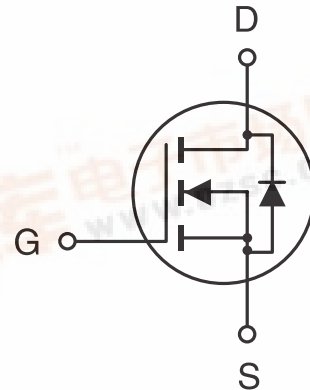

ABSOLUTE MAXIMUM RATINGS (Tc=25°C unless otherwise noted)

Parameter	Symbol	Limit	Unit
Drain-Source Voltage	V _{DS}	60	V
Gate-Source Voltage	V _{GS}	±20	V
Drain Current-Continuous -Pulsed	I _D	75	A
	I _{DM}	225	A
Drain-Source Diode Forward Current	I _S	75	A
Maximum Power Dissipation @T _c =25°C Derate above 25°C	P _D	150	W
		1	W/°C
Operating and Storage Temperature Range	T _J , T _{STG}	-65 to 175	°C

THERMAL CHARACTERISTICS

Thermal Resistance, Junction-to-Case	R _{θJC}	1	°C/W
Thermal Resistance, Junction-to-Ambient	R _{θJA}	62.5	°C/W



CEP7060L/CEB7060L

ELECTRICAL CHARACTERISTICS (Tc=25°C unless otherwise noted)

4

Parameter	Symbol	Condition	Min	Typ	Max	Unit
OFF CHARACTERISTICS						
Drain-Source Breakdown Voltage	BV _{DSS}	V _{GS} =0V, I _D =250μA	60			V
Zero Gate Voltage Drain Current	I _{DSS}	V _{DS} =60V, V _{GS} =0V			25	μA
Gate-Body Leakage	I _{GSS}	V _{GS} =±20V, V _{DS} =0V			±100	nA
ON CHARACTERISTICS^a						
Gate Threshold Voltage	V _{GS(th)}	V _{DS} =V _{GS} , I _D =250μA	1	1.3	2	V
Drain-Source On-State Resistance	R _{DS(ON)}	V _{GS} =5V, I _D =37.5A		10	14	mΩ
On-State Drain Current	I _{D(ON)}	V _{GS} =5V, V _{DS} =10V	60			A
Forward Transconductance	g _{FS}	V _{DS} =10V, I _D =37.5A		60		S
DYNAMIC CHARACTERISTICS^b						
Input Capacitance	C _{ISS}	V _{DS} =25V, V _{GS} =0V f=1.0MHz		2730	3600	pF
Output Capacitance	C _{OSS}			723	1000	pF
Reverse Transfer Capacitance	C _{RSS}			128	170	pF
SWITCHING CHARACTERISTICS^b						
Turn-On Delay Time	t _{D(ON)}	V _{DD} =30V, I _D =75A, V _{GS} =5V, R _{GEN} =10Ω		20	40	ns
Rise Time	t _r			440	600	ns
Turn-Off Delay Time	t _{D(OFF)}			80	150	ns
Fall Time	t _f			250	400	ns
Total Gate Charge	Q _g	V _{DS} =48V, I _D =75A, V _{GS} =5V		104	115	nC
Gate-Source Charge	Q _{gs}			14		nC
Gate-Drain Charge	Q _{gd}			18		nC

CEP7060L/CEB7060L

4

ELECTRICAL CHARACTERISTICS ($T_c=25^\circ\text{C}$ unless otherwise noted)

Parameter	Symbol	Condition	Min	Typ	Max	Unit
DRAIN-SOURCE DIODE CHARACTERISTICS^a						
Diode Forward Voltage	V_{SD}	$V_{GS} = 0V, I_s = 37.5A$		0.86	1.3	V

Notes

a. Pulse Test: Pulse Width $\leq 300 \mu s$, Duty Cycle $\leq 2\%$.

b. Guaranteed by design, not subject to production testing.

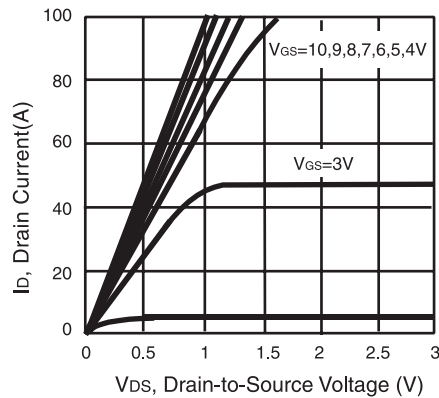

Figure 1. Output Characteristics

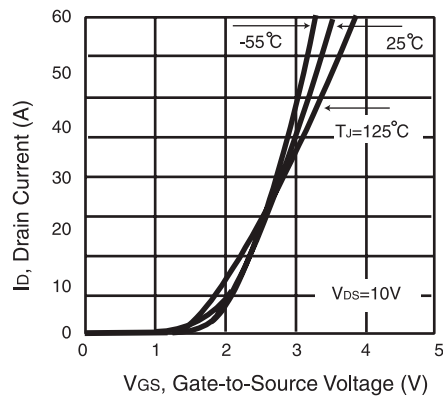

Figure 2. Transfer Characteristics

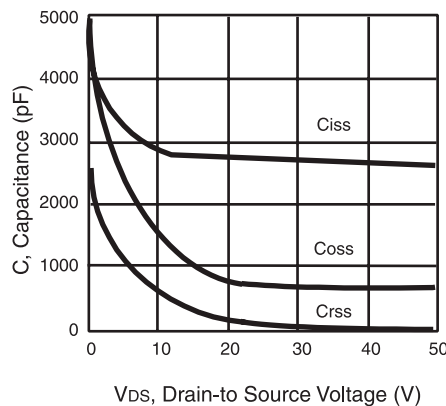

Figure 3. Capacitance

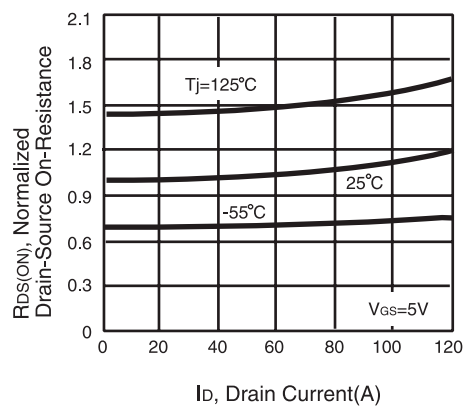

Figure 4. On-Resistance Variation with Drain Current and Temperature

CEP7060L/CEB7060L

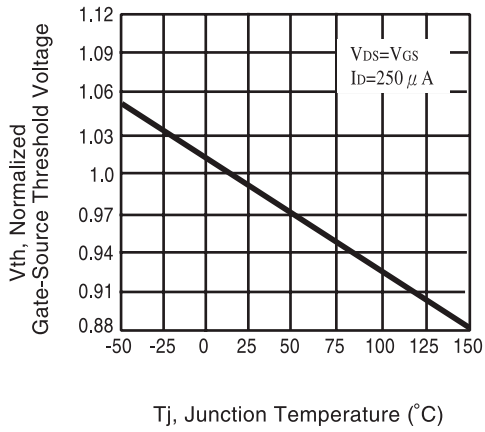

Figure 5. Gate Threshold Variation with Temperature

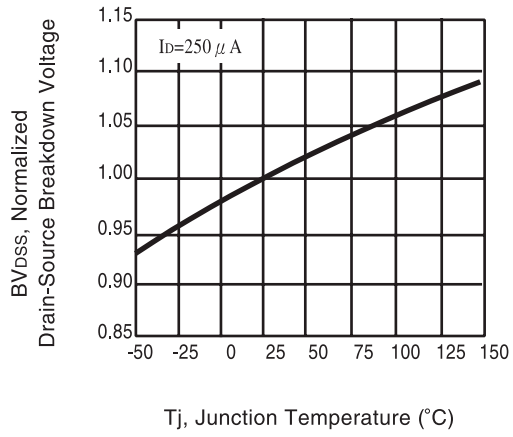

Figure 6. Breakdown Voltage Variation with Temperature

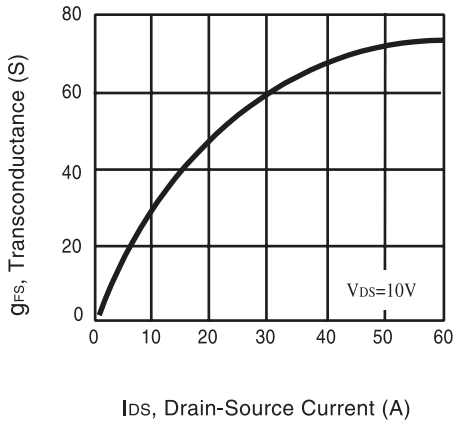

Figure 7. Transconductance Variation with Drain Current

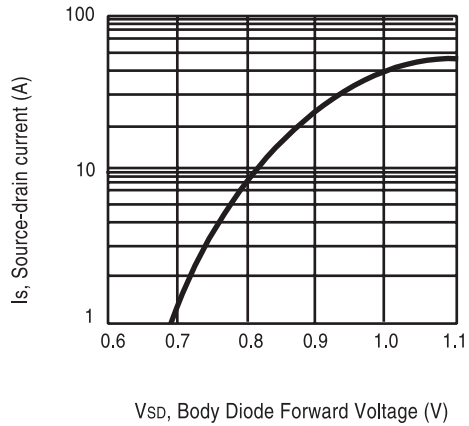

Figure 8. Body Diode Forward Voltage Variation with Source Current

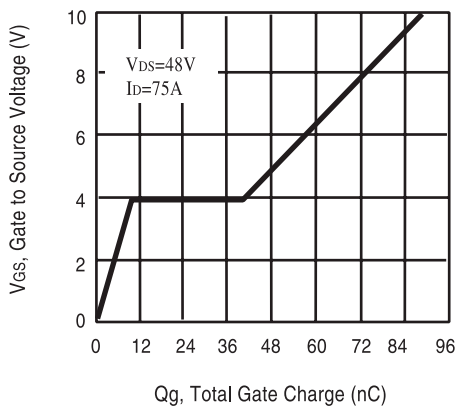

Figure 9. Gate Charge

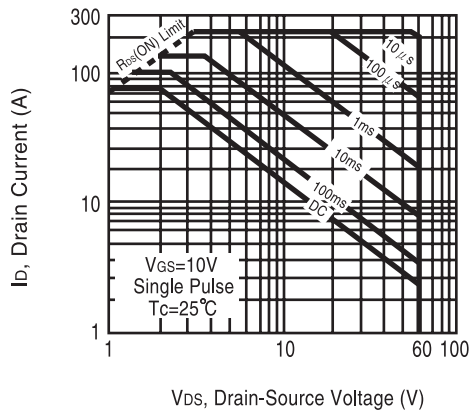

Figure 10. Maximum Safe Operating Area

CEP7060L/CEB7060L

4

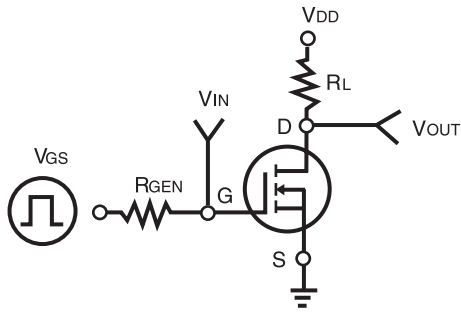

Figure 11. Switching Test Circuit

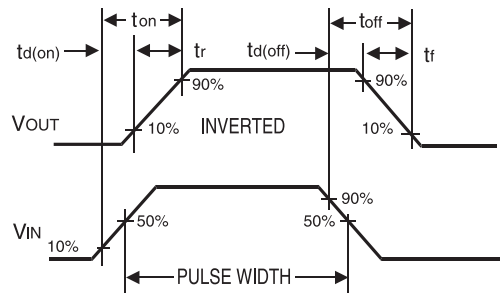

Figure 12. Switching Waveforms

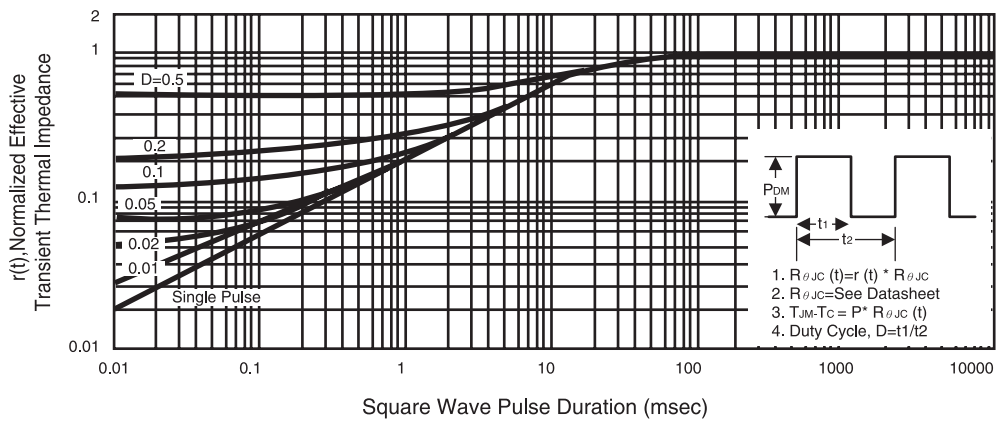

Figure 13. Normalized Thermal Transient Impedance Curve