



CEF09N6

Jul. 2002

N-Channel Logic Level Enhancement Mode Field Effect Transistor

FEATURES

- 600V, 6A, $R_{DS(ON)} = 1.2\Omega$ @ $V_{GS} = 10V$.
- Super high dense cell design for extremely low $R_{DS(ON)}$.
- High power and current handling capability.
- TO-220F full-pak for through hole.

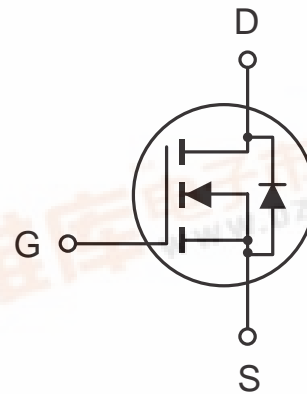
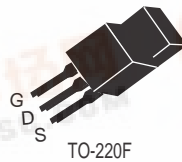

ABSOLUTE MAXIMUM RATINGS (Tc=25°C unless otherwise noted)

Parameter	Symbol	Limit	Unit
Drain-Source Voltage	V _{DS}	600	V
Gate-Source Voltage	V _{GS}	±30	V
Drain Current-Continuous -Pulsed	I _D	5	A
	I _{DM}	15	A
Drain-Source Diode Forward Current	I _S	5	A
Maximum Power Dissipation @T _c =25°C Derate above 25°C	P _D	50	W
		0.38	W/°C
Operating and Storage Temperature Range	T _J , T _{STG}	-55 to 150	°C

THERMAL CHARACTERISTICS

Thermal Resistance, Junction-to-Case	R _{θJC}	2.6	°C/W
Thermal Resistance, Junction-to-Ambient	R _{θJA}	65	°C/W

CEF09N6

ELECTRICAL CHARACTERISTICS (T_c=25°C unless otherwise noted)

6

Parameter	Symbol	Condition	Min	Typ	Max	Unit
DRAIN-SOURCE AVALANCHE RATING^a						
Single Pulse Drain-Source Avalanche Energy	E _{AS}	V _{DD} =50V, L=23.4mH R _G =25Ω		500		mJ
Maximum Drain-Source Avalanche Current	I _{AS}			9		A
OFF CHARACTERISTICS						
Drain-Source Breakdown Voltage	BV _{DSS}	V _{GS} = 0V, I _D = 250μA	600			V
Zero Gate Voltage Drain Current	I _{DSS}	V _{DS} = 600V, V _{GS} = 0V			50	μA
Gate-Body Leakage	I _{GSS}	V _{GS} = ±30V, V _{DS} = 0V			±100	nA
ON CHARACTERISTICS^a						
Gate Threshold Voltage	V _{GS(th)}	V _{DS} = V _{GS} , I _D = 250μA	2		4	V
Drain-Source On-State Resistance	R _{DS(ON)}	V _{GS} = 10V, I _D = 6A		1.0	1.2	Ω
On-State Drain Current	I _{D(ON)}	V _{GS} = 10V, V _{DS} = 10V	5			A
Forward Transconductance	g _{FS}	V _{DS} = 50V, I _D = 6A	3	5		S
SWITCHING CHARACTERISTICS^b						
Turn-On Delay Time	t _{D(ON)}	V _{DD} = 200V, I _D = 9A, V _{GS} = 10V R _{GEN} =9.1Ω		23	45	ns
Rise Time	t _r			26	50	ns
Turn-Off Delay Time	t _{D(OFF)}			105	165	ns
Fall Time	t _f			22	45	ns
Total Gate Charge	Q _g	V _{DS} = 480V, I _D = 9A, V _{GS} = 10V		73	85	nC
Gate-Source Charge	Q _{gs}			6.0		nC
Gate-Drain Charge	Q _{gd}			45		nC

CEF09N6

ELECTRICAL CHARACTERISTICS ($T_c=25^\circ\text{C}$ unless otherwise noted)

Parameter	Symbol	Condition	Min	Typ	Max	Unit
DYNAMIC CHARACTERISTICS^b						
Input Capacitance	C_{iss}	$V_{DS}=25\text{V}, V_{GS}=0\text{V}$ $f=1.0\text{MHz}$		950		pF
Output Capacitance	C_{oss}			135		pF
Reverse Transfer Capacitance	C_{rss}			90		pF
DRAIN-SOURCE DIODE CHARACTERISTICS^a						
Diode Forward Voltage	V_{SD}	$V_{GS}=0\text{V}, I_s=9\text{A}$			1.5	V

6

Notes

a. Pulse Test: Pulse Width $\leq 300 \mu\text{s}$, Duty Cycle $\leq 2\%$.

b. Guaranteed by design, not subject to production testing.

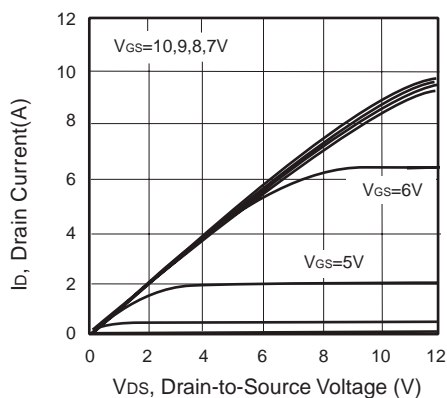

Figure 1. Output Characteristics

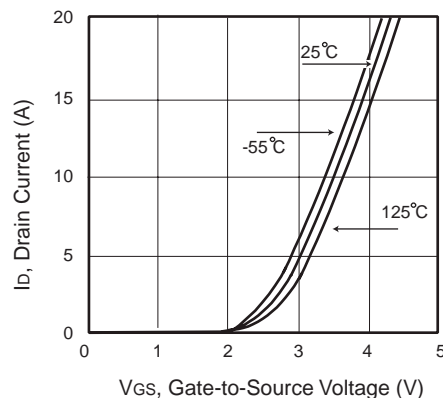

Figure 2. Transfer Characteristics

CEF09N6

6

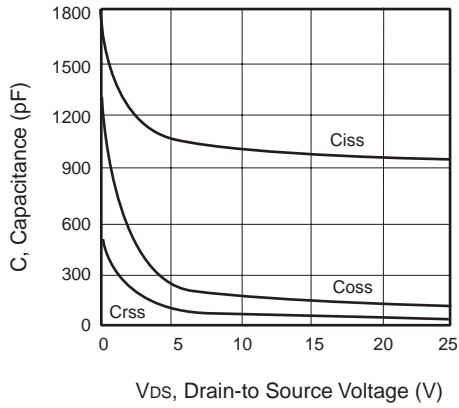

Figure 3. Capacitance

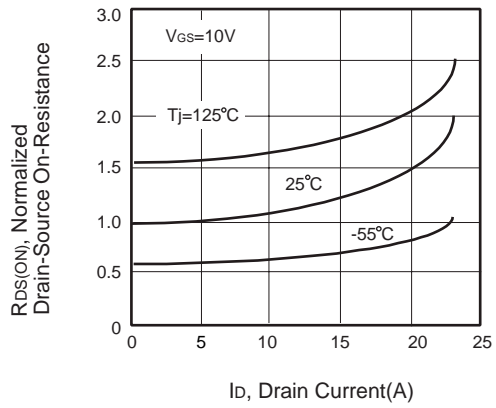

Figure 4. On-Resistance Variation with Drain Current and Temperature

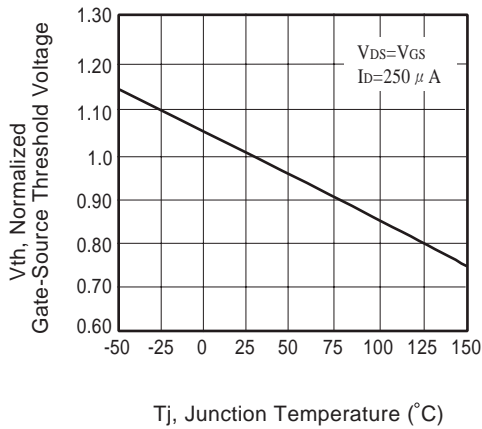

Figure 5. Gate Threshold Variation with Temperature

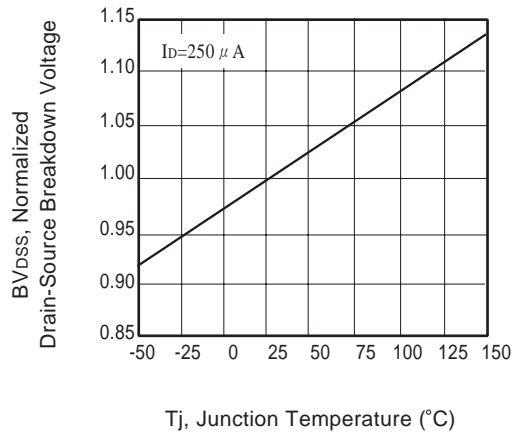

Figure 6. Breakdown Voltage Variation with Temperature

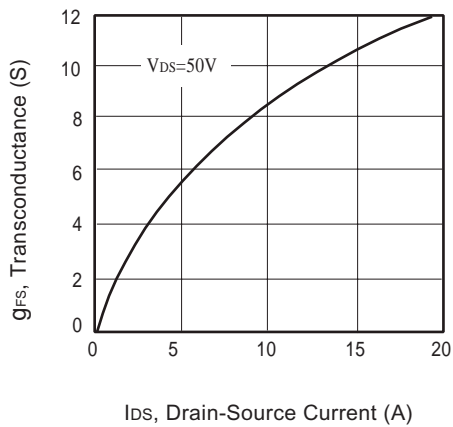

Figure 7. Transconductance Variation with Drain Current

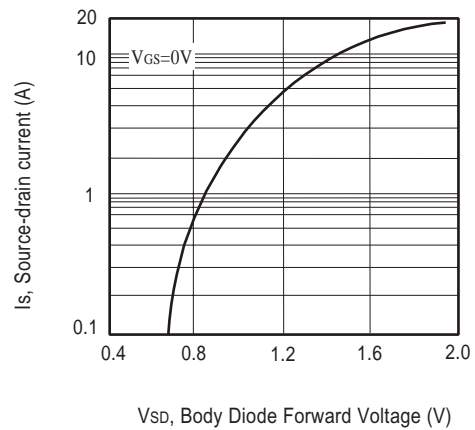

Figure 8. Body Diode Forward Voltage Variation with Source Current

CEF09N6

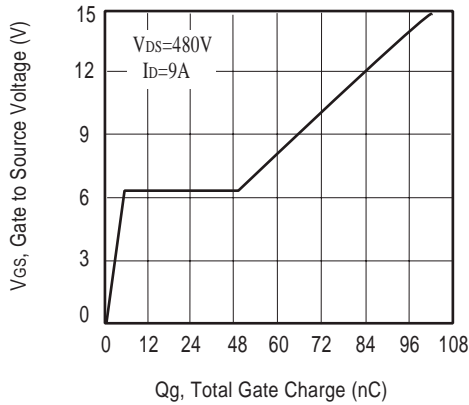

Figure 9. Gate Charge

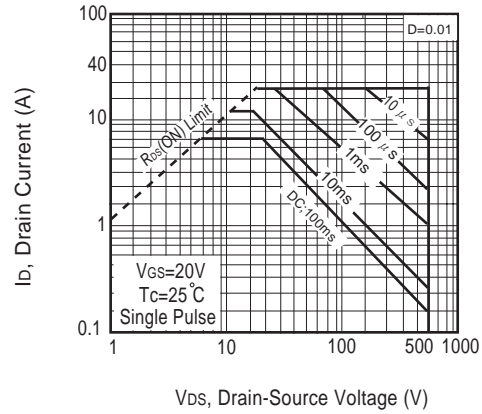

Figure 10. Maximum Safe Operating Area

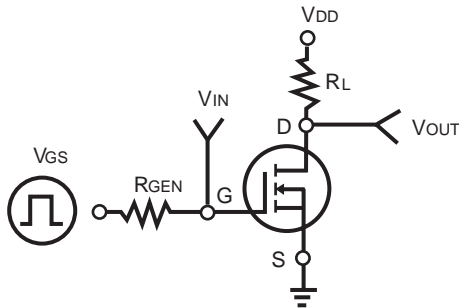

Figure 11. Switching Test Circuit

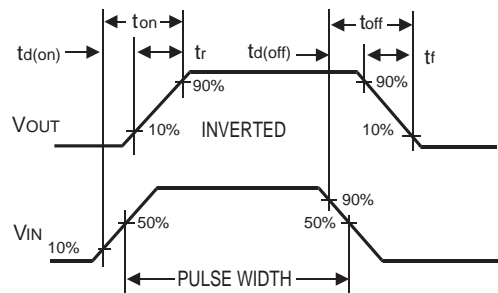

Figure 12. Switching Waveforms

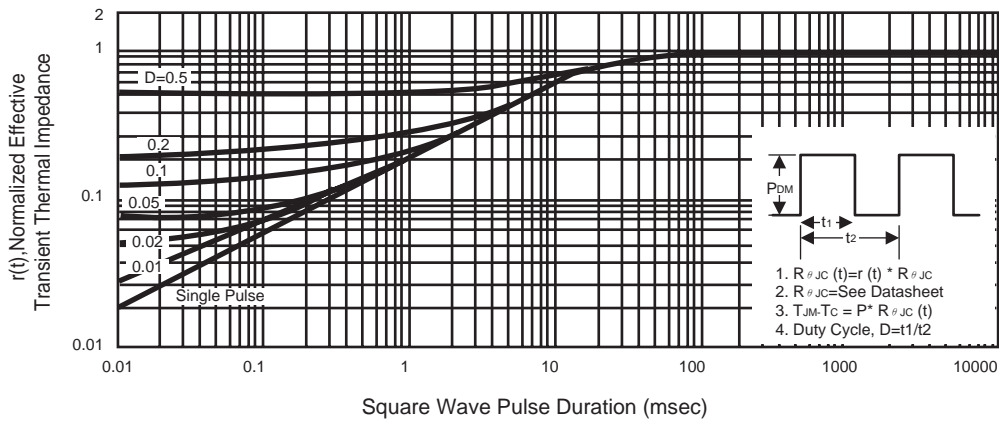

Figure 13. Normalized Thermal Transient Impedance Curve