

Preliminary data

- * Low noise preamplifier for mobile communication (PCN, DECT, GSM) in 2.7V to 6V systems
- * Biased monolithic microwave IC (MMIC)
- * Easily matchable to 50Ω
- * No bias coil needed
- * Single positive supply voltage
- * Low noise figure and high gain
 NF=1.3dB, G=16.5dB @ 3V, 950MHz (typ.)
 NF=1.7dB, G=12dB @ 3V, 1.85GHz (typ.)
- * Low power consumption
- * Frequency range 200 MHz ... 2.5 GHz
- * Miniature package MW6 based on SOT23

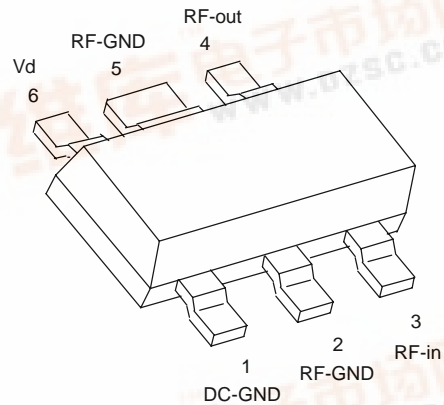

ESD: **E**lectrostatic **d**ischarge sensitive device, observe handling precautions!

Type	Marking	Ordering code (taped)	Package 1)
CGY 59	Y5	Q68000-A8887	MW-6

Maximum ratings	Symbol		Unit
Drain voltage	V_D	8	V
Channel temperature	T_{Ch}	150	°C
Storage temperature range	T_{stg}	-55...+150	°C
Total power dissipation ($T_S \leq 132^\circ\text{C}$) ²⁾	P_{tot}	80	mW
Thermal resistance			
Channel-soldering point (GND)	R_{thChS}	≤ 220	K/W
Junction-ambient ³⁾	R_{thJA}	< 300	K/W

1) Dimensions see chapter Package Outlines
 2) Please care for sufficient heat dissipation on the pcb!
 3) Package mounted on alumina 15mm x16.7 mm x0.7 mm

Electrical characteristics of CGY59 in GSM application circuit (see page 4)

 $T_A = 25^\circ\text{C}$ $f=950\text{MHz}$ $R_S = R_L = 50\Omega$

unless otherwise specified

Characteristics	Symbol	min	typ	max	Unit
Drain current	I_D	-	6	-	mA
Power Gain Ud = 3V Ud = 5V	G	- -	16.5 18	- -	dB
Noise figure Ud = 3V Ud = 5V	F	- -	1.3 1.3	- -	dB
Input return loss Ud = 3V Ud = 5V	RL_{in}	- -	10 11	- -	dB
Output return loss Ud = 3V Ud = 5V	RL_{out}	- -	11 9	- -	dB
Third order input intercept point two-tone intermodulation test f1 = 950MHz, f2 = 951MHz Pin = -20dBm (both carriers) Ud = 3V Ud = 5V	IP_3	- -	-4 -2	- -	dBm
Input power at 1dB gain compression Ud = 3V Ud = 5V	P_{-1dB}	- -	-13 -11.5	- -	dBm

Electrical characteristics of CGY59 in 1850 MHz application circuit (see page 4)

$T_A = 25^\circ\text{C}$

$f=1850\text{MHz}$

$R_S = R_L = 50\Omega$

unless otherwise specified

Characteristics	Symbol	min	typ	max	Unit
Drain current	I_D	-	6	-	mA
Power Gain Ud = 3V Ud = 5V	G	- -	12 13	- -	dB
Noise figure Ud = 3V Ud = 5V	F	- -	1.70 1.65	- -	dB
Input return loss Ud = 3V Ud = 5V	RL_{in}	- -	15 16	- -	dB
Output return loss Ud = 3V Ud = 5V	RL_{out}	- -	15.5 13	- -	dB
Third order input intercept point two-tone intermodulation test f1 = 1850MHz, f2 = 1851MHz Pin = -20dBm (both carriers) Ud = 3V Ud = 5V	IP_3	- -	1 2	- -	dBm
Input power at 1dB gain compression Ud = 3V Ud = 5V	P_{-1dB}	- -	-8 -6	- -	dBm

950MHz Application (GSM)

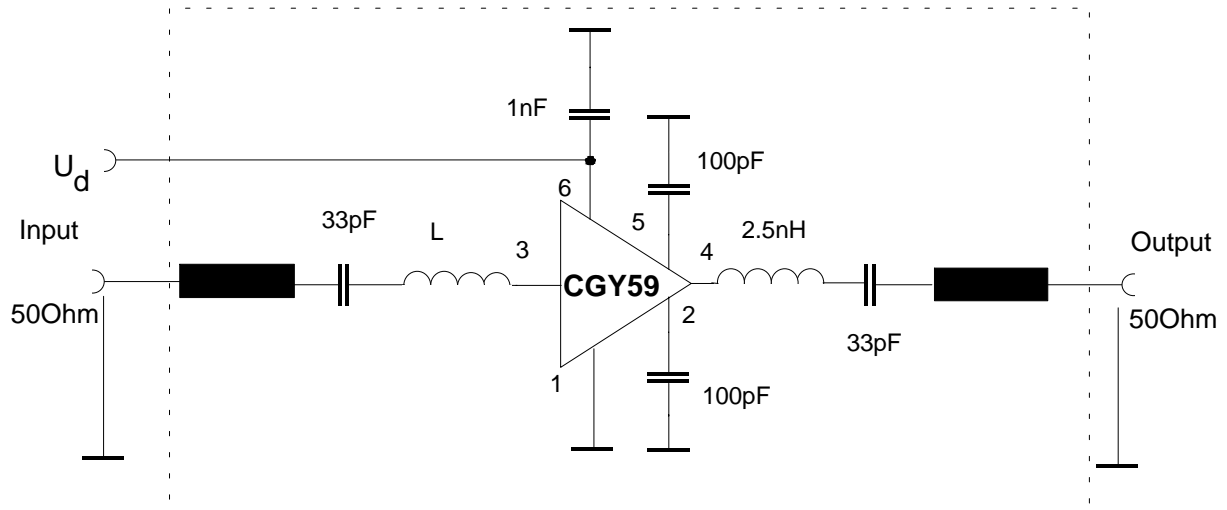

50 Ohm Microstripline

L = Inductor 22nH (Coilcraft 0805CS-220-XMBC)

1850MHz Application (PCN, DECT)

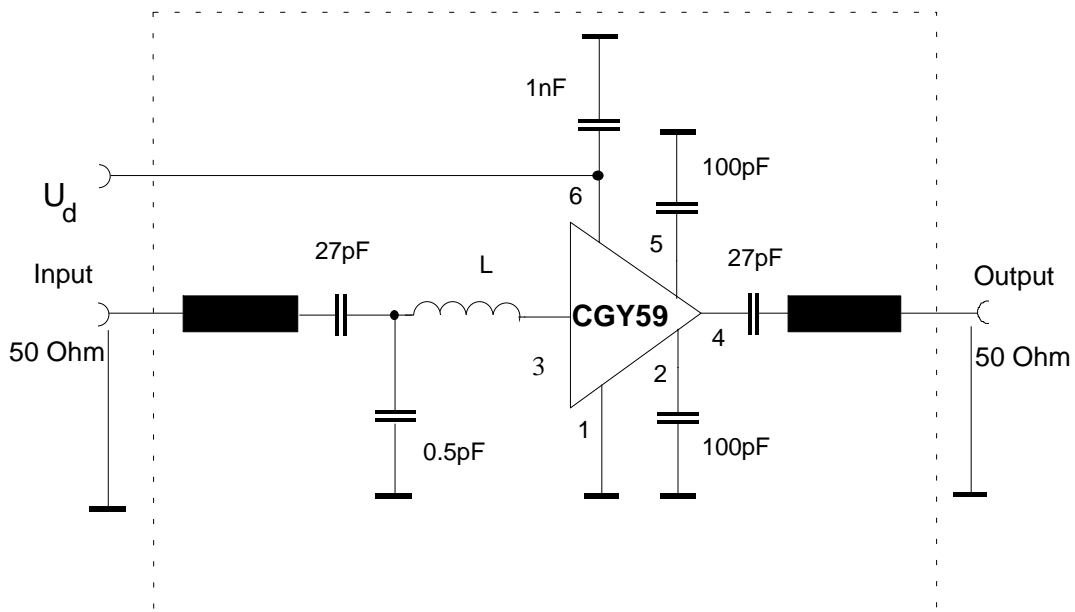

50 Ohm Microstripline

L = Inductor 6.8nH (Coilcraft 0805CS-060-XMBC)

PCB - Layouts for Application Circuits

950MHz GSM - application board:

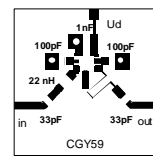
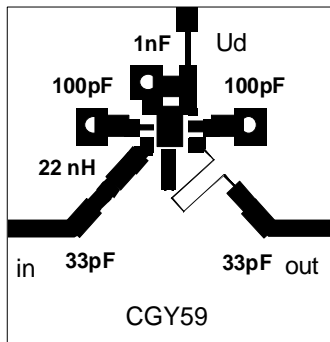

Actual size
(20 x 20 mm)

1850MHz PCN -, DECT - application board:

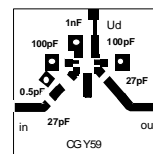
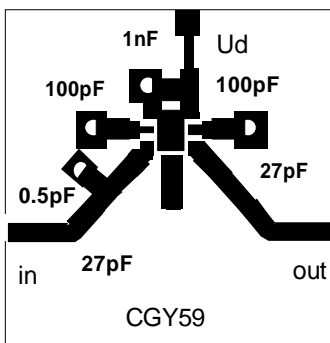

Actual size
(20 x 20 mm)

PCB - data: Glass fiber teflon board (double sided) TACONIC TLX-9-0150-CH/CH
 $\epsilon_r = 2.45$ thickness = 0.4mm

Typical S- and Noise-Parameters

$V_D = 3\text{ V}$

$Z_0 = 50\Omega$

f/GHz	S11		S21		S12		S22	
	MAG	ANG	MAG	ANG	MAG	ANG	MAG	ANG
0.1	0.999	-4	4.30	-177	0.006	-75	0.261	-17
0.2	0.998	-6.6	4.32	-173	0.011	97.6	0.251	-10
0.3	0.997	-10	4.30	-167	0.010	94	0.247	-11
0.4	0.982	-14	4.26	161	0.016	76	0.238	-12
0.5	0.970	-18	4.24	156	0.019	78	0.232	-13
0.6	0.958	-21	4.16	151	0.020	78	0.226	-15
0.7	0.940	-24	4.13	146	0.023	73	0.221	-16
0.8	0.918	-27	4.02	141	0.026	79	0.218	-18
0.9	0.889	-32	3.91	136	0.031	79	0.209	-22
1.0	0.870	-34	3.82	132	0.033	76	0.195	-21
1.1	0.845	-37	3.76	128	0.036	75	0.189	-23
1.2	0.829	-39	3.63	123	0.039	73	0.186	-24
1.3	0.806	-42	3.58	119	0.041	72	0.177	-24
1.4	0.789	-45	3.47	115	0.043	71	0.173	-24
1.5	0.765	-47	3.39	111	0.046	71	0.166	-24
1.6	0.748	-50	3.29	107	0.046	72	0.159	-24
1.7	0.725	-52	3.21	104	0.051	71	0.154	-22
1.8	0.703	-54	3.14	100	0.051	71	0.147	-21
1.9	0.695	-56	3.08	97	0.055	69	0.140	-18
2.0	0.664	-58	2.98	93	0.056	71	0.135	-15
2.1	0.644	-59	2.86	90	0.059	70	0.129	-13
2.2	0.631	-61	2.83	86	0.062	69	0.123	-9.6
2.3	0.605	-63	2.79	83	0.063	69	0.114	-3.4
2.4	0.590	-65	2.70	80	0.064	69	0.109	2.7
2.5	0.570	-67	2.65	76	0.065	70	0.106	9.2

f	Fmin	Γ_{opt}	RN
GHz	dB	MAG	Ω
		ANG	
		deg	
0.8	1.15	0.77	19
1.0	1.19	0.74	22
1.2	1.24	0.72	27
1.4	1.31	0.71	32
1.6	1.39	0.70	36
1.8	1.49	0.68	39
2.0	1.62	0.66	43

S- and noise-parameters are also available on CD-ROM.

Typical S- and Noise-Parameters

$V_D = 5 \text{ V}$

$Z_0 = 50 \Omega$

f/GHz	S11		S21		S12		S22	
	MAG	ANG	MAG	ANG	MAG	ANG	MAG	ANG
0.1	0.998	-3.4	4.99	-177	0.007	-73	0.366	-15
0.2	0.997	-6.8	4.97	-173	0.008	30	0.331	-8.8
0.3	0.995	-10	4.99	-167	0.012	96	0.328	-9.2
0.4	0.976	-14	4.98	161	0.012	82	0.316	-11
0.5	0.963	-17	4.91	156	0.014	89	0.318	-12
0.6	0.957	-21	4.81	151	0.020	77	0.306	-14
0.7	0.942	-24	4.76	146	0.022	83	0.302	-16
0.8	0.920	-27	4.63	141	0.027	79	0.297	-17
0.9	0.887	-31	4.50	136	0.031	79	0.289	-21
1.0	0.871	-33	4.40	132	0.033	75	0.276	-21
1.1	0.846	-36	4.31	128	0.035	75	0.269	-22
1.2	0.826	-39	4.16	123	0.037	75	0.263	-22
1.3	0.807	-41	4.12	119	0.039	70	0.256	-24
1.4	0.788	-44	4.01	116	0.042	73	0.246	-24
1.5	0.762	-46	3.91	112	0.043	72	0.240	-24
1.6	0.744	-49	3.77	108	0.047	71	0.234	-25
1.7	0.723	-51	3.69	105	0.048	71	0.229	-24
1.8	0.703	-53	3.60	101	0.051	70	0.221	-23
1.9	0.687	-55	3.50	98	0.052	71	0.215	-22
2.0	0.665	-57	3.42	94	0.054	72	0.208	-21
2.1	0.647	-58	3.28	91	0.057	72	0.203	-20
2.2	0.636	-60	3.25	88	0.058	70	0.193	-59
2.3	0.611	-62	3.20	84	0.060	69	0.184	-17
2.4	0.595	-63	3.14	82	0.062	70	0.176	-14
2.5	0.573	-66	3.06	78	0.063	71	0.172	-11

f	Fmin	Γ_{opt}		RN
GHz	dB	MAG	ANG	Ω
		-	deg	
0.8	1.13	0.76	18	58.5
1.0	1.16	0.74	21	56.3
1.2	1.21	0.73	27	52.7
1.4	1.26	0.72	30	49.1
1.6	1.33	0.70	34	48.5
1.8	1.42	0.68	38	45.2
2.0	1.55	0.66	42	43.4

S- and noise-parameters are also available on CD-ROM.

Application Circuit for measuring S-parameters

f = 200MHz to 2.5GHz

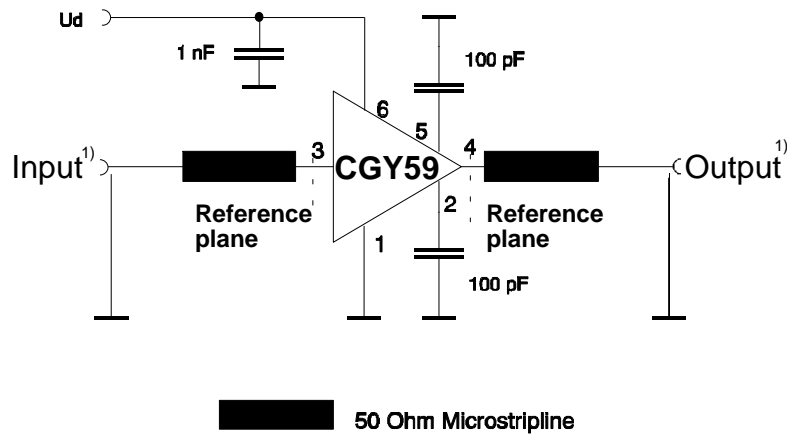

1) Caution! DC - decoupling capacitors are not integrated in device is an approved CECC manufacturer.