

6A 200V Cathode Common

SBD Type : ECH06A20-F

OUTLINE DRAWING

For High Frequency Rectification

FEATURES

- * High VRM SBD
- * Low Forward Voltage Drop and Low Noise
- * Fully Molded Isolation
- * Dual Diodes Cathode Common

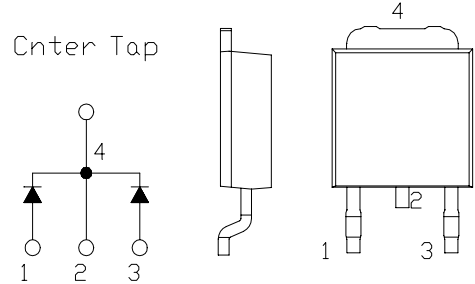

Maximum Ratings

Approx Net Weight:0.30g

Rating	Symbol	ECH06A20-F			Unit
Repetitive Peak Reverse Voltage	V_{RRM}	200			V
Average Rectified Output Current	I_o	6.0	$T_c=116^{\circ}C$	50 Hz, Full Sine Wave Resistive Load	A
		1.0	$T_a=30^{\circ}C$	50 Hz, Full Sine Wave Resistive Load P.C.Board mounted *	
RMS Forward Current	$I_{F(RMS)}$	6.66			A
Surge Forward Current	I_{FSM}	60	50 Hz Full Sine Wave, 1cycle Non-repetitive		A
Operating Junction Temperature Range	T_{jw}	- 40 to + 150			$^{\circ}C$
Storage Temperature Range	T_{stg}	- 40 to + 150			$^{\circ}C$

Electrical • Thermal Characteristics

Characteristics	Symbol	Conditions	Min.	Typ.	Max.	Unit
Peak Reverse Current	I_{RM}	$T_j=25^{\circ}C, V_{RM}=V_{RRM}$ per Diode	-	-	200	μA
Peak Forward Voltage	V_{FM}	$T_j=25^{\circ}C, I_{FM}=3A$ per Diode	-	-	0.90	V
Thermal Resistance	$R_{th(j-c)}$	Junction to Case	-	-	5	$^{\circ}C/W$
	$R_{th(j-a)}$	Junction to Ambient With P.C.Board mounted *	-	-	80	

*: Print Land 20x20

ECH06A20-F OUTLINE DRAWING (Dimensions in mm)

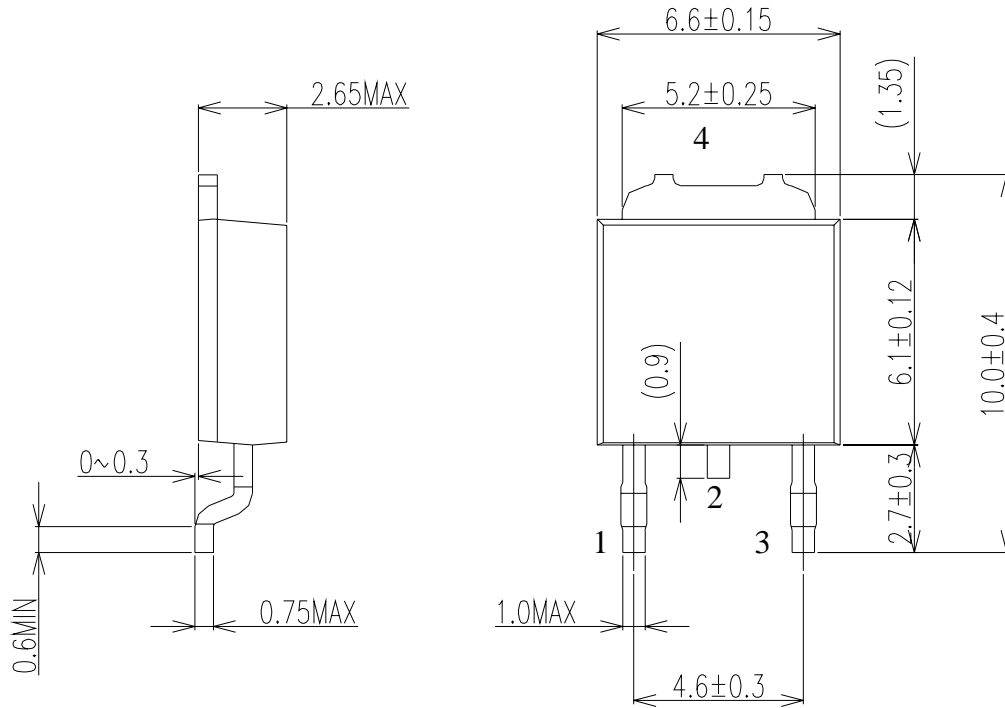

Soldering PAD

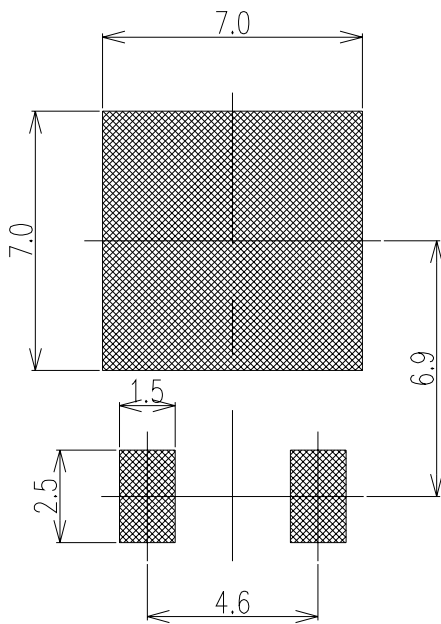

Center Tap

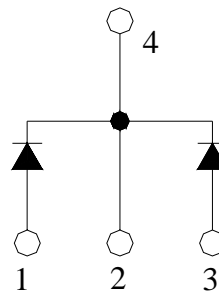

FORWARD CURRENT VS. VOLTAGE

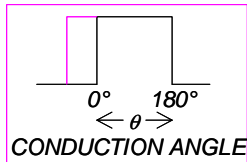
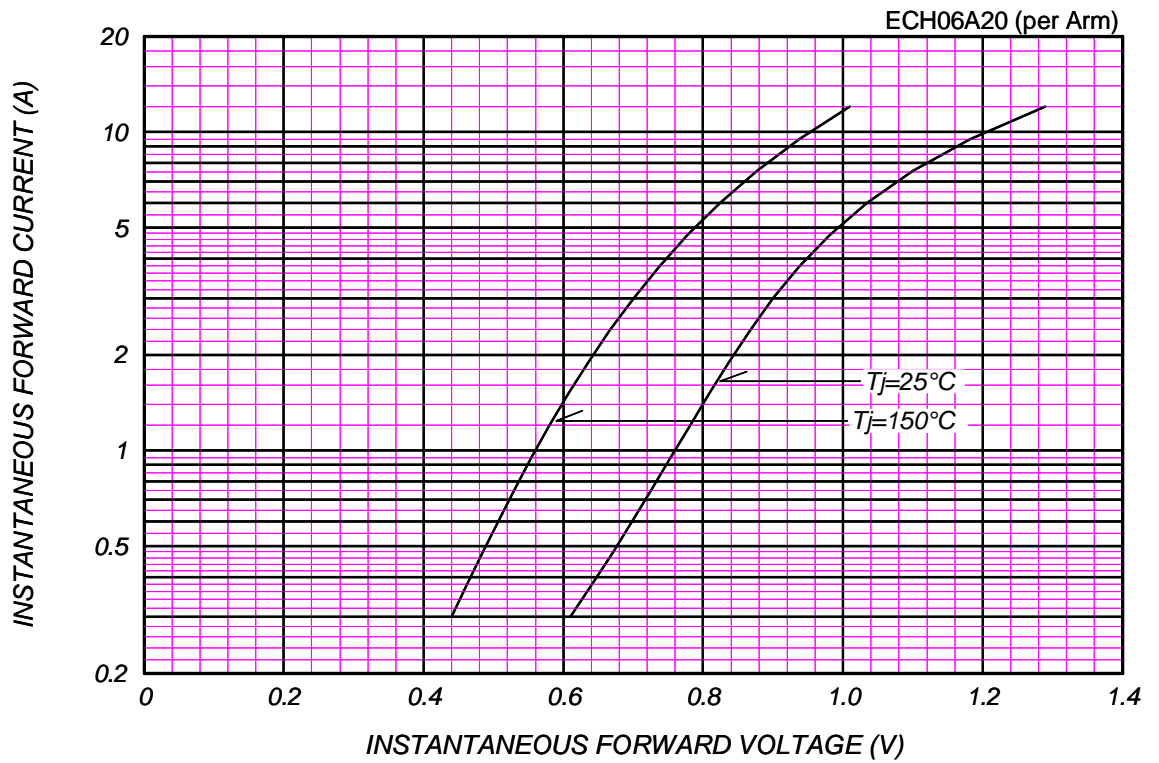

AVERAGE FORWARD POWER DISSIPATION

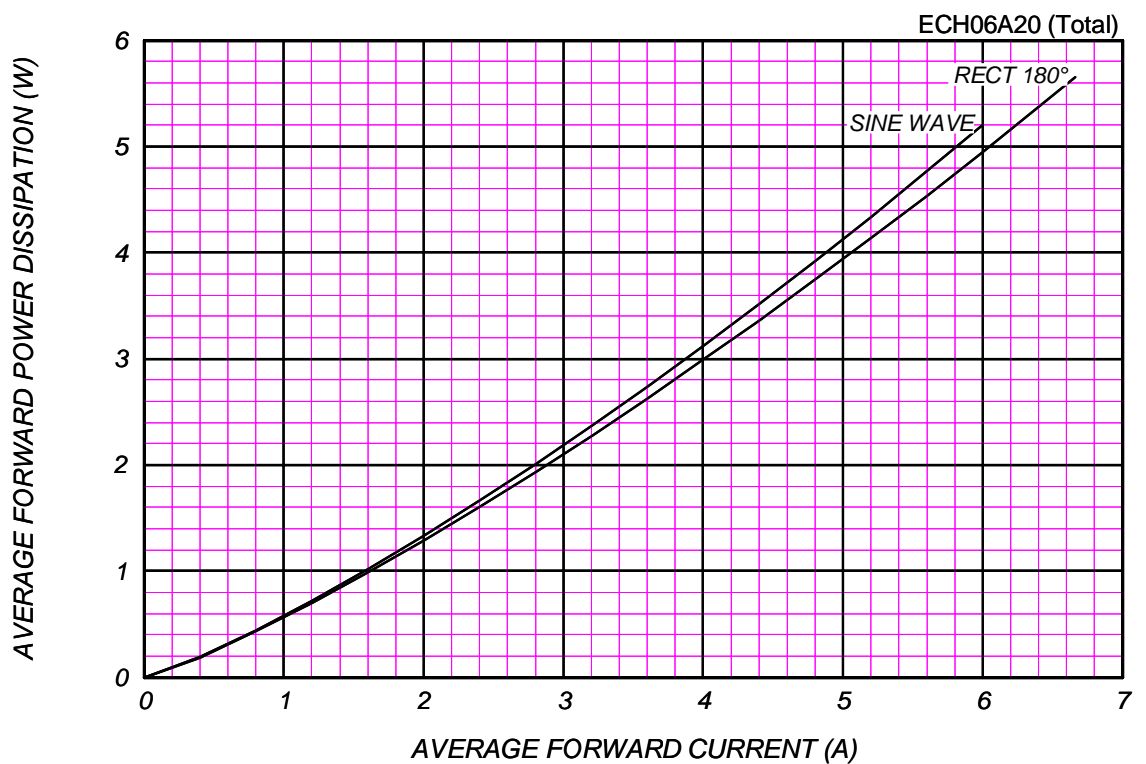

PEAK REVERSE CURRENT VS. PEAK REVERSE VOLTAGE

$T_j = 150\text{ }^\circ\text{C}$

ECH06A20 (per Arm)

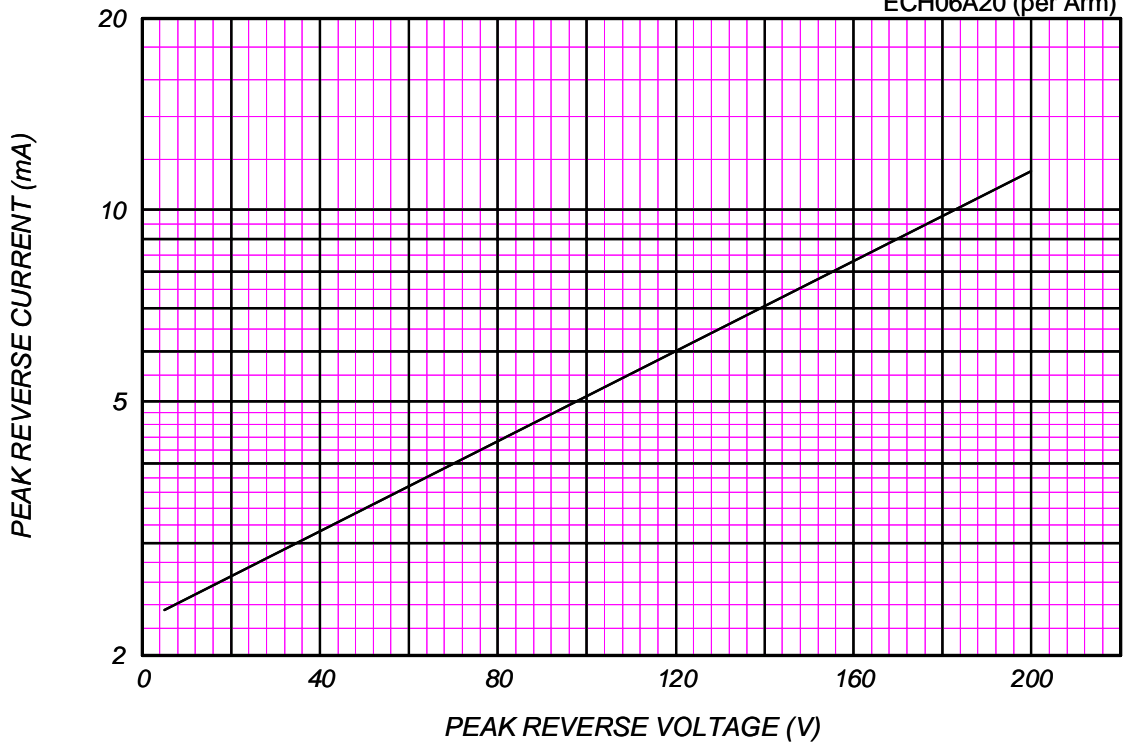

AVERAGE REVERSE POWER DISSIPATION

ECH06A20 (Total)

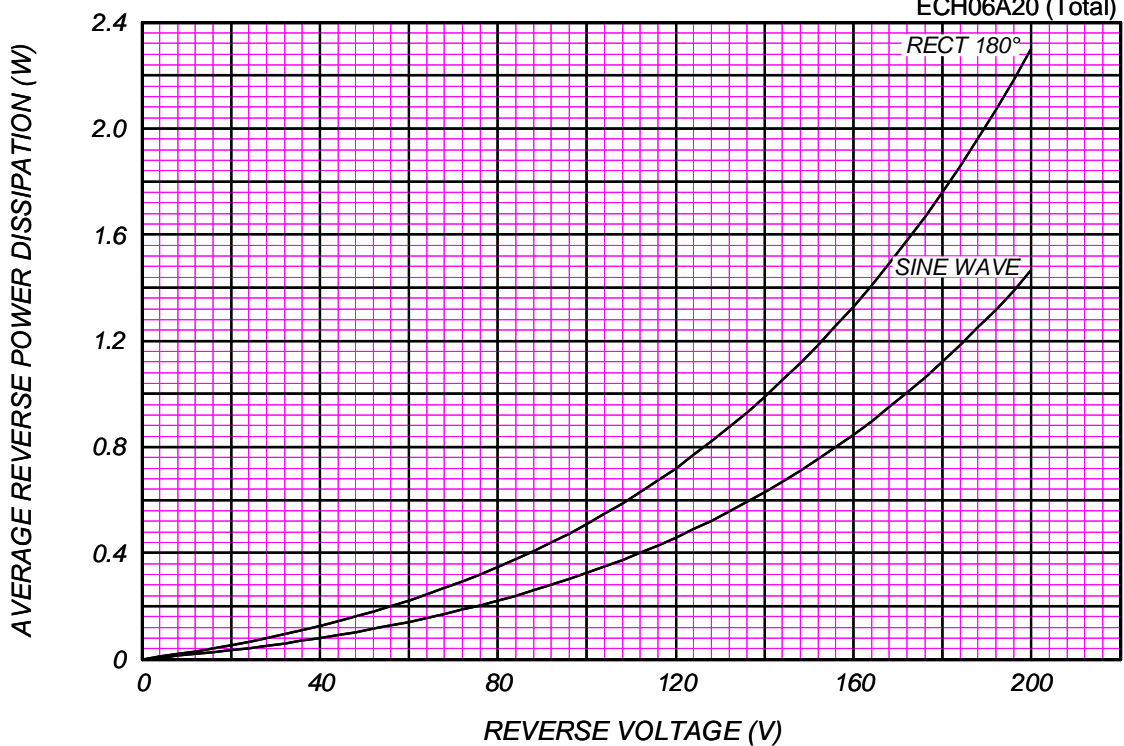

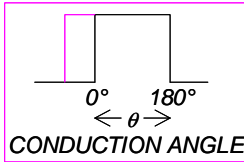

AVERAGE FORWARD CURRENT VS. CASE TEMPERATURE

$V_{RM}=200V$

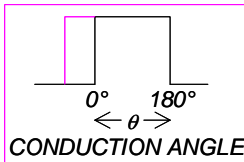
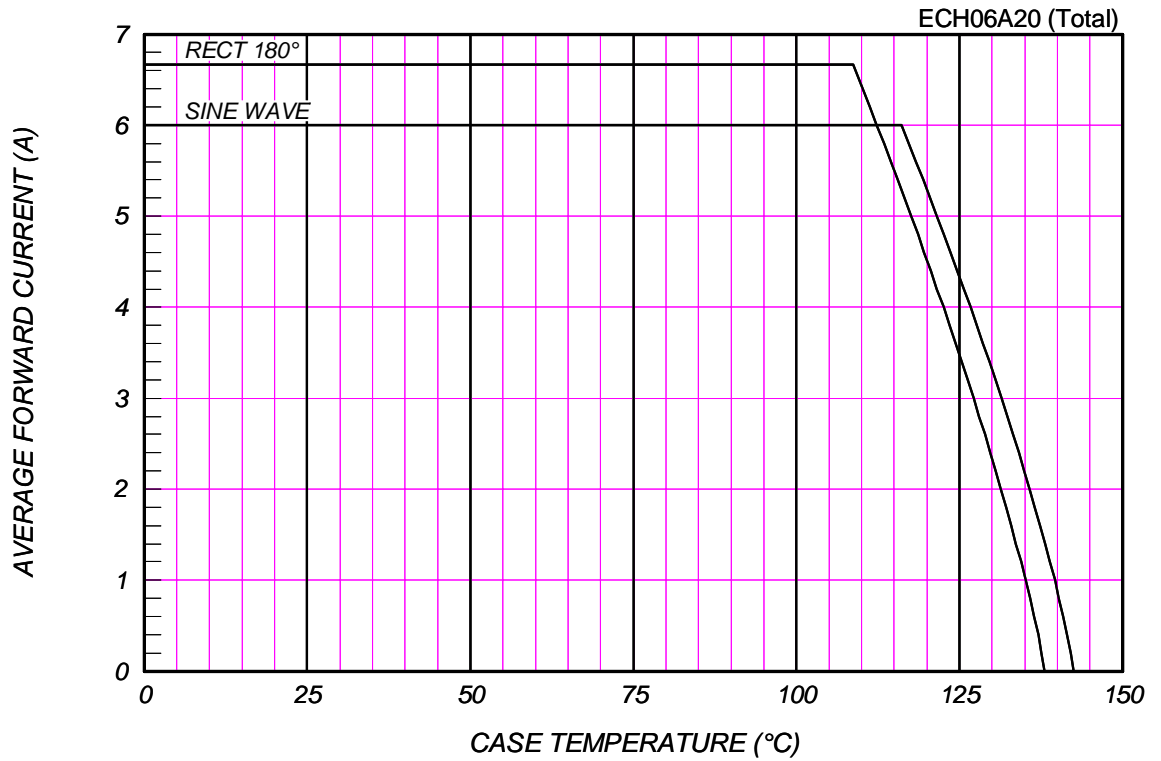

AVERAGE FORWARD CURRENT VS. AMBIENT TEMPERATURE

P.C. Board mounted(Print land=20x20mm), $V_{RM}=200V$

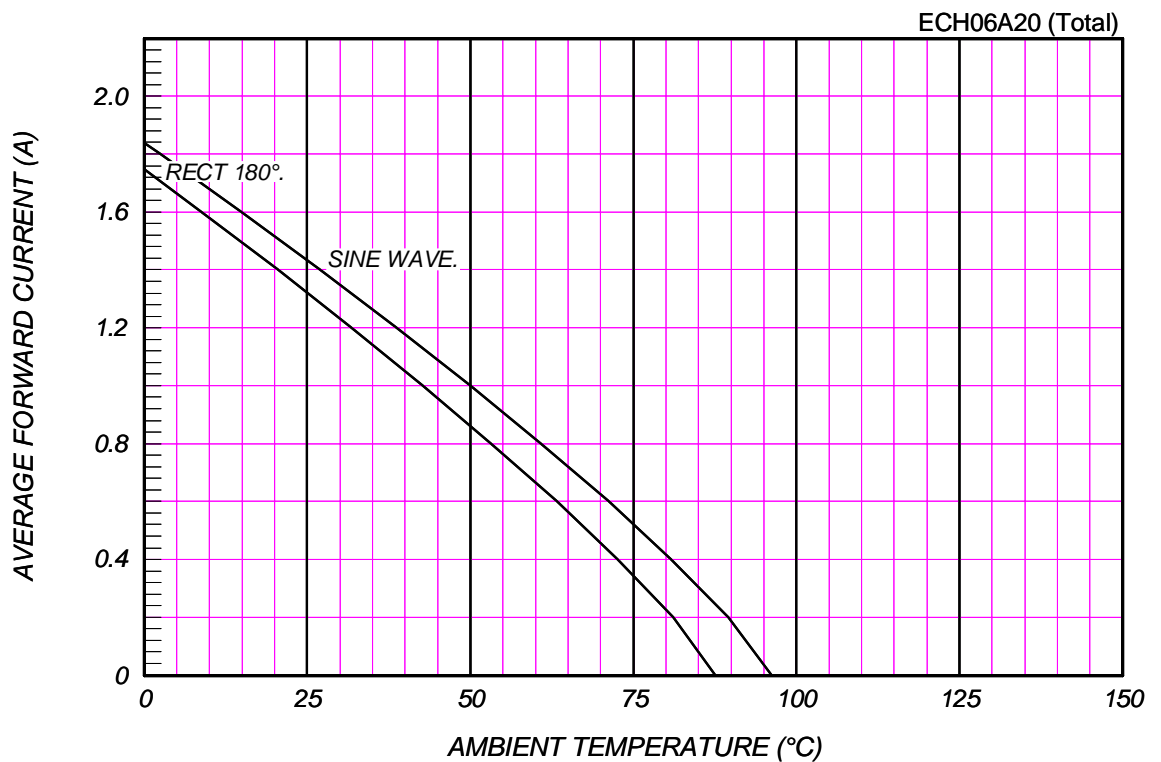

SURGE CURRENT RATINGS

f=50Hz,Sine Wave,Non-Repetitive,No Load

ECH06A20

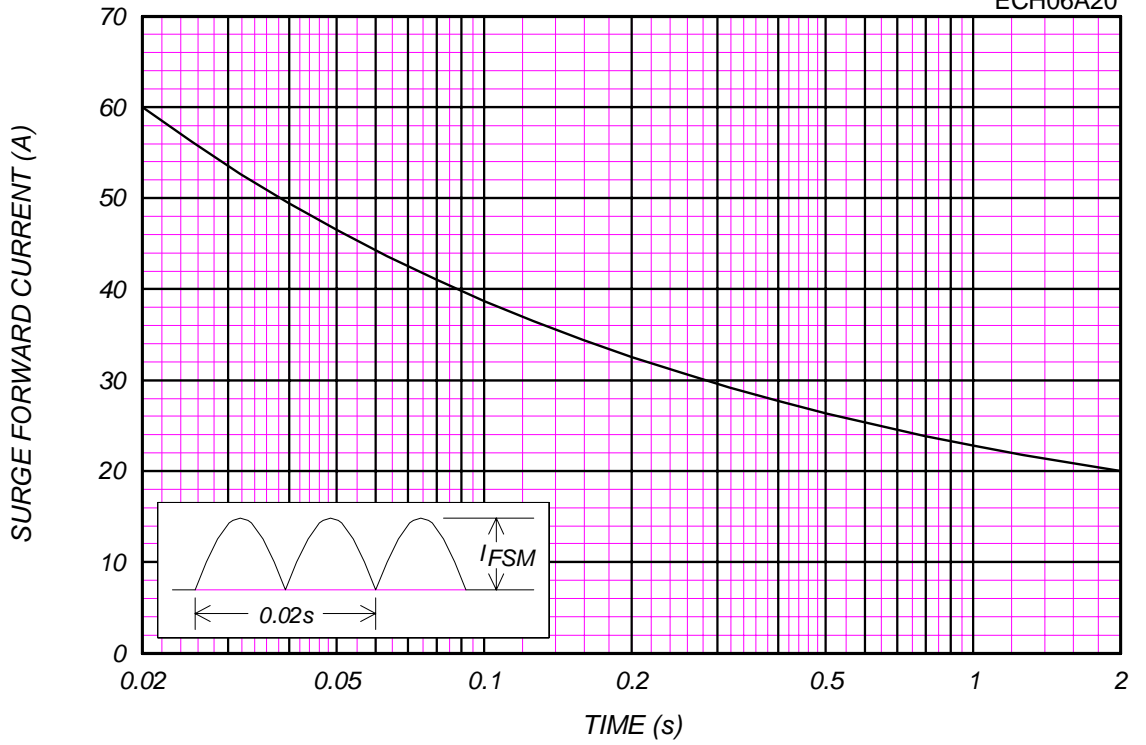

JUNCTION CAPACITANCE VS. REVERSE VOLTAGE

T_j=25°C,V_m=20mV_{RMS},f=100kHz,Typical Value

ECH06A20 (per Arm)

