



# Wideband, High Output Current, Fast Settling Op Amp

## AD842\*

### FEATURES

#### AC PERFORMANCE

Gain Bandwidth Product: 80 MHz (Gain = 2)  
 Fast Settling: 100 ns to 0.01% for a 10 V Step  
 Slew Rate: 375 V/ $\mu$ s  
 Stable at Gains of 2 or Greater  
 Full Power Bandwidth: 6.0 MHz for 20 V p-p

#### DC PERFORMANCE

Input Offset Voltage: 1 mV max  
 Input Offset Drift: 14  $\mu$ V/ $^{\circ}$ C  
 Input Voltage Noise: 9 nV/ $\sqrt{\text{Hz}}$  typ  
 Open-Loop Gain: 90 V/mV into a 500  $\Omega$  Load  
 Output Current: 100 mA min  
 Quiescent Supply Current: 14 mA max

### APPLICATIONS

Line Drivers  
 DAC and ADC Buffers  
 Video and Pulse Amplifiers  
 Available in Plastic DIP, Hermetic Metal Can, Hermetic Cerdip, SOIC and LCC Packages and in Chip Form  
 MIL-STD-883B Parts Available  
 Available in Tape and Reel in Accordance with EIA-481A Standard

### PRODUCT DESCRIPTION

The AD842 is a member of the Analog Devices family of wide bandwidth operational amplifiers. This device is fabricated using Analog Devices' junction isolated complementary bipolar (CB) process. This process permits a combination of dc precision and wideband ac performance previously unobtainable in a monolithic op amp. In addition to its 80 MHz gain bandwidth, the AD842 offers extremely fast settling characteristics, typically settling to within 0.01% of final value in less than 100 ns for a 10 volt step.

The AD842 also offers a low quiescent current of 13 mA, a high output current drive capability (100 mA minimum), a low input voltage noise of 9 nV/ $\sqrt{\text{Hz}}$  and a low input offset voltage (1 mV maximum).

The 375 V/ $\mu$ s slew rate of the AD842, along with its 80 MHz gain bandwidth, ensures excellent performance in video and pulse amplifier applications. This amplifier is ideally suited for use in high frequency signal conditioning circuits and wide bandwidth active filters. The extremely rapid settling time of the AD842 makes this amplifier the preferred choice for data acquisition applications which require 12-bit accuracy. The

### CONNECTION DIAGRAMS

Plastic DIP (N) Package and Cerdip (Q) Package

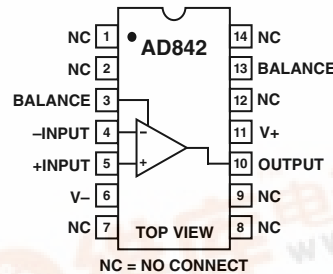

LCC (E) Package

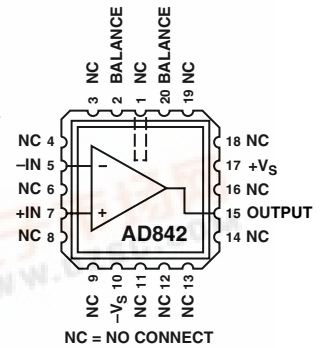

TO-8 (H) Package

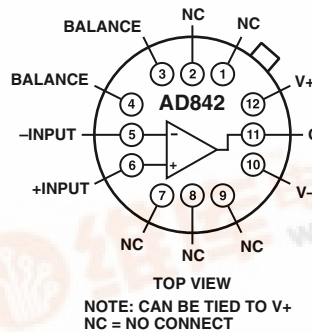

SOIC (R-16) Package

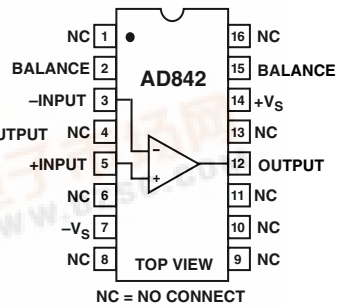

AD842 is also appropriate for other applications such as high speed DAC and ADC buffer amplifiers and other wide bandwidth circuitry.

### APPLICATION HIGHLIGHTS

1. The high slew rate and fast settling time of the AD842 make it ideal for DAC and ADC buffers amplifiers, lines drivers and all types of video instrumentation circuitry.
2. The AD842 is a precision amplifier. It offers accuracy to 0.01% or better and wide bandwidth; performance previously available only in hybrids.
3. Laser-wafer trimming reduces the input offset voltage of 1 mV max, thus eliminating the need for external offset nulling in many applications.
4. Full differential inputs provide outstanding performance in all standard high frequency op amp applications where the circuit gain will be 2 or greater.
5. The AD842 is an enhanced replacement for the HA2542.

\*Covered by U.S. Patent Nos. 4,969,823 and 5,141,898.

REV E

Information furnished by Analog Devices is believed to be accurate and reliable. However, no responsibility is assumed by Analog Devices for its use, nor for any infringements of patents or other rights of third parties which may result from its use. No license is granted by implication or otherwise under any patent or patent rights of Analog Devices.

# AD842—SPECIFICATIONS (@ +25°C and ±15 V dc, unless otherwise noted)

Model	Conditions	AD842J/JR <sup>1</sup>			AD842K			AD842S <sup>2</sup>			Units
		Min	Typ	Max	Min	Typ	Max	Min	Typ	Max	
INPUT OFFSET VOLTAGE <sup>3</sup>		0.5	1.5		0.3	1.0		0.5	1.5		mV
Offset Drift	T <sub>MIN</sub> –T <sub>MAX</sub>		2.5/3			1.5			3.5		mV μV/°C
INPUT BIAS CURRENT		4.2	8		3.5	5		4.2	8		μA
Input Offset Current	T <sub>MIN</sub> –T <sub>MAX</sub>		10			6			12		μA
	T <sub>MIN</sub> –T <sub>MAX</sub>	0.1	0.4		0.05	0.2		0.1	0.4		μA
	T <sub>MIN</sub> –T <sub>MAX</sub>		0.5			0.3			0.6		μA
INPUT CHARACTERISTICS	Differential Mode										
Input Resistance		100			100			100			kΩ
Input Capacitance		2.0			2.0			2.0			pF
INPUT VOLTAGE RANGE											
Common Mode		±10			±10			±10			V
Common-Mode Rejection	V <sub>CM</sub> = ±10 V	86	115		90	115		86	115		dB
	T <sub>MIN</sub> –T <sub>MAX</sub>	80			86			80			dB
INPUT VOLTAGE NOISE	f = 1 kHz	9			9			9			nV/√Hz
Wideband Noise	10 Hz to 10 MHz	28			28			28			μV rms
OPEN-LOOP GAIN	V <sub>O</sub> = ±10 V										
	R <sub>LOAD</sub> ≥ 500 Ω	40/30	90		50	90		40	90		V/mV
	T <sub>MIN</sub> –T <sub>MAX</sub>	20/15			25			20			V/mV
OUTPUT CHARACTERISTICS											
Voltage	R <sub>LOAD</sub> ≥ 500 Ω	±10			±10			±10			V
Current	V <sub>OUT</sub> = ±10 V	100			100			100			mA
	Open Loop		5			5			5		Ω
FREQUENCY RESPONSE											
Gain Bandwidth Product	V <sub>OUT</sub> = 90 mV		80			80			80		MHz
Full Power Bandwidth <sup>4</sup>	V <sub>O</sub> = 20 V p-p										
	R <sub>LOAD</sub> ≥ 500 Ω	4.7	6		4.7	6		4.7	6		MHz
Rise Time <sup>5</sup>	A <sub>VCL</sub> = –2		10			10			10		ns
Overshoot <sup>5</sup>	A <sub>VCL</sub> = –2		20			20			20		%
Slew Rate <sup>5</sup>	A <sub>VCL</sub> = –2	300	375		300	375		300	375		V/μs
Settling Time <sup>5</sup>	10 V Step										
	to 0.1%		80			80			80		ns
	to 0.01%		100			100			100		ns
Differential Gain	f = 4.4 MHz		0.015			0.015			0.015		%
Differential Phase	f = 4.4 MHz		0.035			0.035			0.035		Degree
POWER SUPPLY											
Rated Performance			±15			±15			±15		V
Operating Range		±5		±18	±5		±18	±5		±18	V
Quiescent Current			13/14	14/16		13	14		13	14	mA
	T <sub>MIN</sub> –T <sub>MAX</sub>			16/19.5			16			19	mA
Power Supply Rejection Ratio	V <sub>S</sub> = ±5 V to ±18 V	86	100		90	105		86	100		dB
	T <sub>MIN</sub> –T <sub>MAX</sub>	80			86			80			dB
TEMPERATURE RANGE											
Rated Performance <sup>6</sup>		0		+75	0		+75	–55		+125	°C
PACKAGE OPTIONS											
Plastic (N-14)			AD842JN			AD842KN					
Cerdip (Q-14)			AD842JQ			AD842KQ				AD842SQ, AD842SQ/883B	
SOIC (R-16)			AD842JR-16								
Tape and Reel			AD842JR-16-REEL								
			AD842JR-16-REEL7								
TO-8 (H-12A)			AD842JH			AD842KH				AD842SH	
LCC (E-20A)										AD842SE/883B	
Chips			AD842JCHIPS							AD842SCHIPS	

## NOTES

<sup>1</sup>AD842JR specifications differ from those of the AD842JN, JQ and JH due to the thermal characteristics of the SOIC package.

<sup>2</sup>Standard Military Drawing available 5962-8964201xx

2A – (SE/883B); XA – (SH/883B); CA – (SQ/883B).

<sup>3</sup>Input offset voltage specifications are guaranteed after 5 minutes at T<sub>A</sub> = +25°C.

<sup>4</sup>Full power bandwidth = slew rate/2 π V<sub>PEAK</sub>.

<sup>5</sup>Refer to Figures 22 and 23.

<sup>6</sup>“S” grade T<sub>MIN</sub>–T<sub>MAX</sub> specifications are tested with automatic test equipment at T<sub>A</sub> = –55°C and T<sub>A</sub> = +125°C.

All min and max specifications are guaranteed. Specifications shown in **boldface** are tested on all production units.

Specifications subject to change without notice.

## ABSOLUTE MAXIMUM RATINGS<sup>1</sup>

Supply Voltage	±18 V
Internal Power Dissipation <sup>2</sup>	
Plastic (N)	1.3 W
Cerdip (Q)	1.1 W
TO-8 (H)	1.3 W
SOIC (R)	1.3 W
LCC (E)	1.0 W
Input Voltage	±V <sub>S</sub>
Differential Input Voltage	±6 V
Storage Temperature Range	
Q, H, E	-65°C to +150°C
N, R	-65°C to +125°C
Junction Temperature	+175°C
Lead Temperature Range (Soldering 60 sec)	+300°C

## NOTES

<sup>1</sup>Stresses above those listed under Absolute Maximum Ratings may cause permanent damage to the device. This is a stress rating only; functional operation of the device at these or any other conditions above those indicated in the operational section of this specification is not implied. Exposure to absolute maximum rating conditions for extended periods may affect device reliability.

<sup>2</sup>Maximum internal power dissipation is specified so that T<sub>J</sub> does not exceed +150°C at an ambient temperature of +25°C.

### Thermal Characteristics:

	θ <sub>JC</sub>	θ <sub>JA</sub>	θ <sub>SA</sub>
Plastic Package	30°C/W	100°C/W	
Cerdip Package	30°C/W	110°C/W	38°C/W
TO-8 Package	30°C/W	100°C/W	27°C/W
16-Lead SOIC Package	30°C/W	100°C/W	
20-Lead LCC Package	35°C/W	150°C/W	

Recommended Heat Sink: Aavid Engineering® #602B

## METALIZATION PHOTOGRAPH

Contact factory for latest dimensions.  
Dimensions shown in inches and (mm).

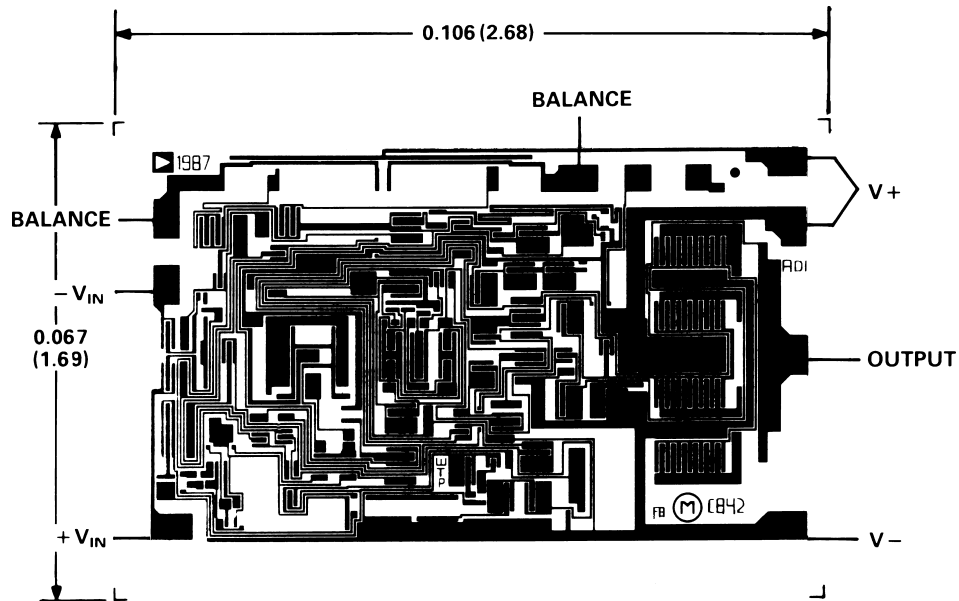

# AD842—Typical Characteristics (at +25°C and $V_S = \pm 15\text{ V}$ , unless otherwise noted)

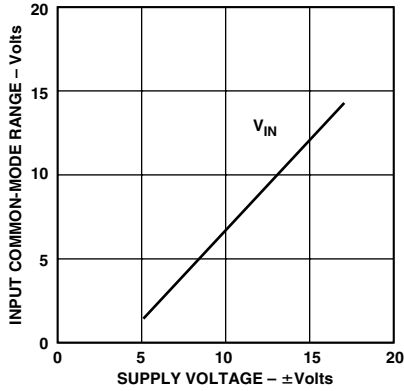

Figure 1. Input Common-Mode Range vs. Supply Voltage

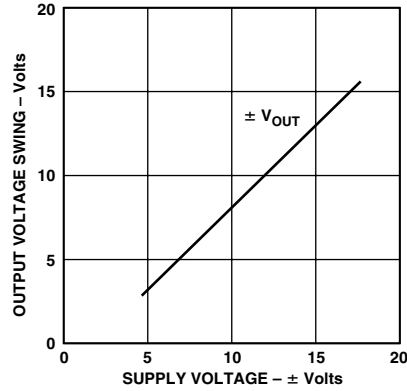

Figure 2. Output Voltage Swing vs. Supply Voltage

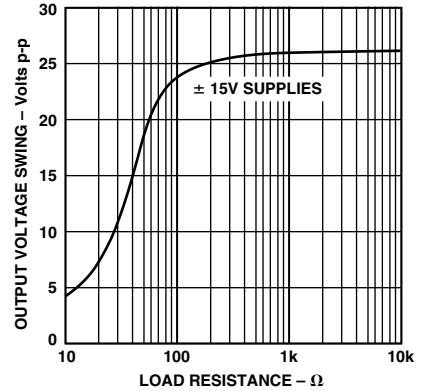

Figure 3. Output Voltage Swing vs. Load Resistance

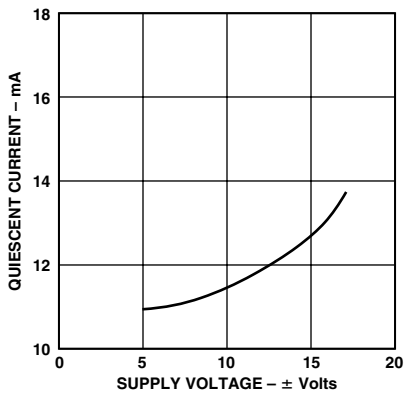

Figure 4. Quiescent Current vs. Supply Voltage

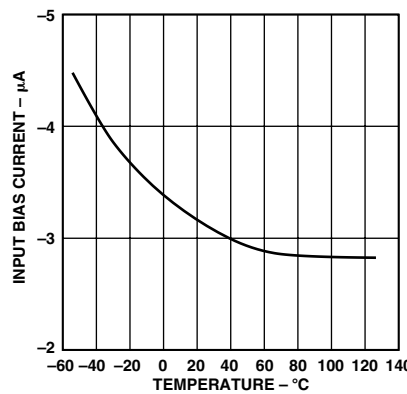

Figure 5. Input Bias Current vs. Temperature

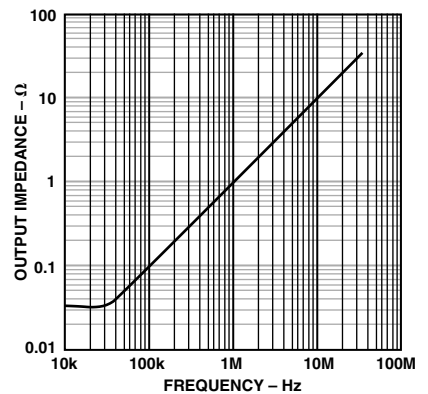

Figure 6. Output Impedance vs. Frequency

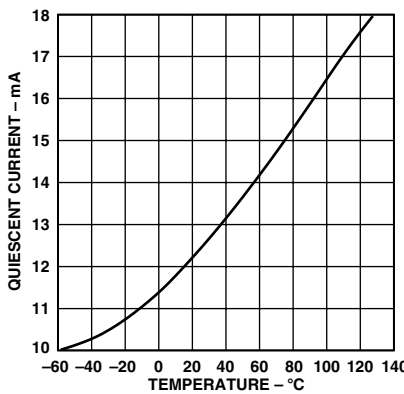

Figure 7. Quiescent Current vs. Temperature

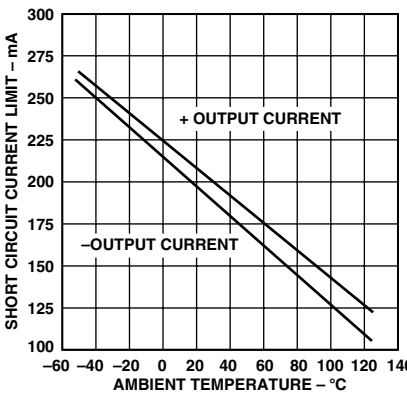

Figure 8. Short-Circuit Current Limit vs. Temperature

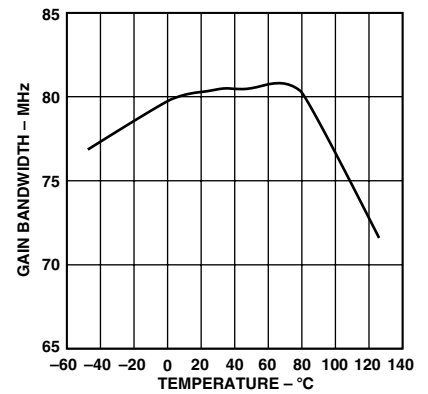

Figure 9. Gain Bandwidth Product vs. Temperature

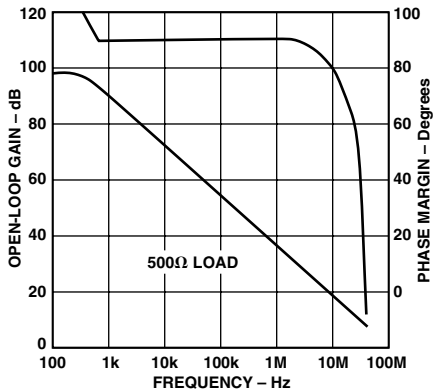

Figure 10. Open-Loop Gain and Phase Margin vs. Frequency

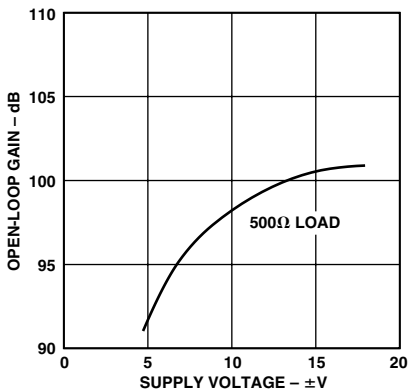

Figure 11. Open-Loop Gain vs. Supply Voltage

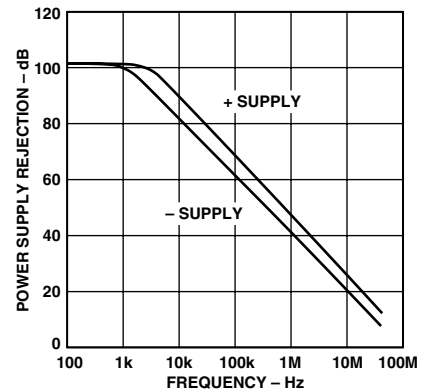

Figure 12. Power Supply Rejection vs. Frequency

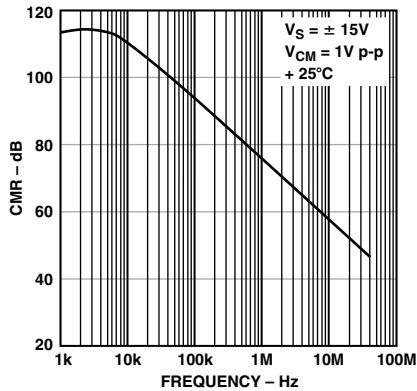

Figure 13. Common-Mode Rejection vs. Frequency

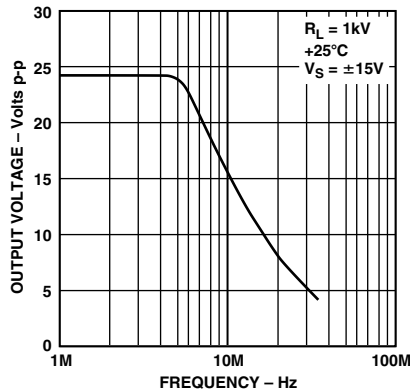

Figure 14. Large Signal Frequency Response

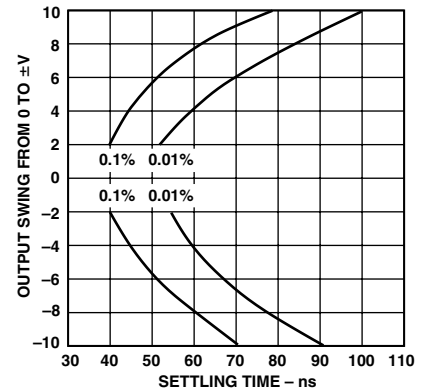

Figure 15. Output Swing and Error vs. Settling Time

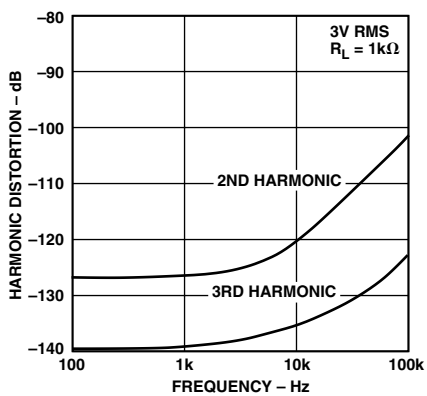

Figure 16. Harmonic Distortion vs. Frequency

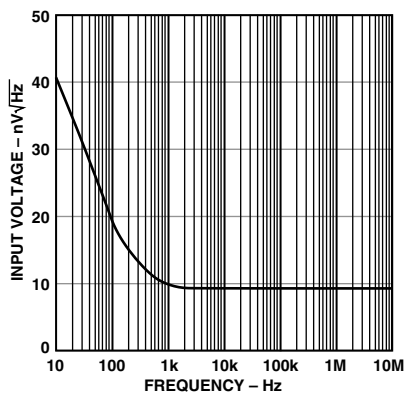

Figure 17. Input Voltage vs. Frequency

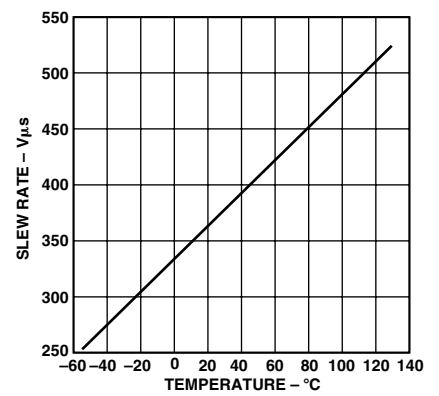

Figure 18. Slew Rate vs. Temperature

# AD842

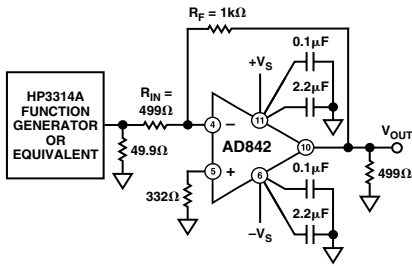

Figure 19a. Inverting Amplifier Configuration (DIP Pinout)

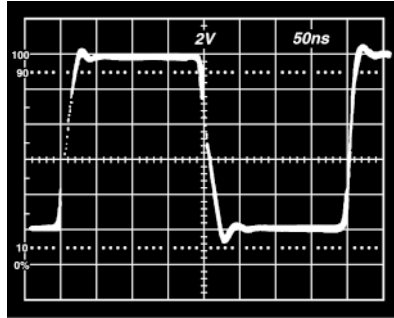

Figure 19b. Inverter Large Signal Pulse Response

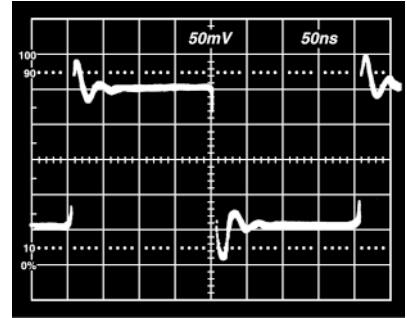

Figure 19c. Inverter Small Signal Pulse Response

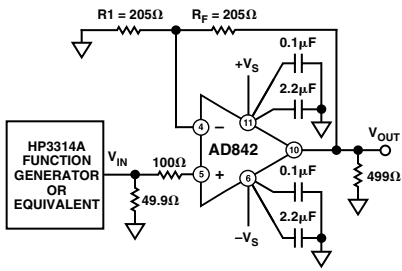

Figure 20a. Noninverting Amplifier Configuration (DIP Pinout)

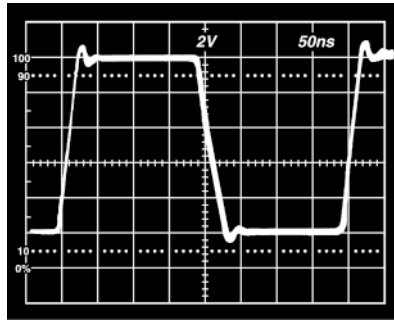

Figure 20b. Noninverting Large Signal Pulse Response

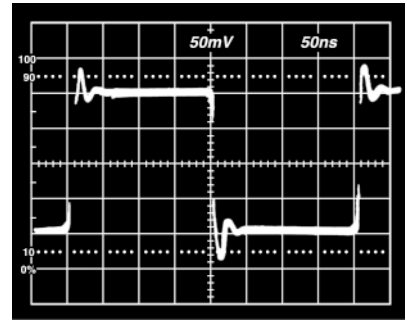

Figure 20c. Noninverting Small Signal Pulse Response

## OFFSET NULLING

The input offset voltage of the AD842 is very low for a high speed op amp, but if additional nulling is required, the circuit shown in Figure 21 can be used.

## AD842 SETTling TIME

Figures 22 and 24 show the settling performance of the AD842 in the test circuit shown in Figure 23.

Settling time is defined as:

The interval of time from the application of an ideal step function input until the closed-loop amplifier output has entered and remains within a specified error band.

This definition encompasses the major components which comprise settling time. They include (1) propagation delay through the amplifier; (2) slewing time to approach the final output value; (3) the time of recovery from the overload associated with slewing and (4) linear settling to within the specified error band.

Expressed in these terms, the measurement of settling time is obviously a challenge and needs to be done accurately to assure the user that the amplifier is worth consideration for the application.

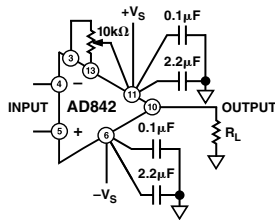

Figure 21. Offset Nulling (DIP Pinout)

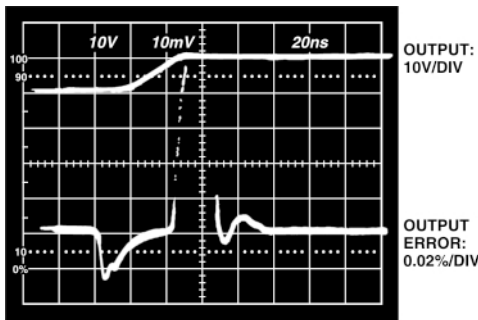

Figure 22. 0.01% Settling Time

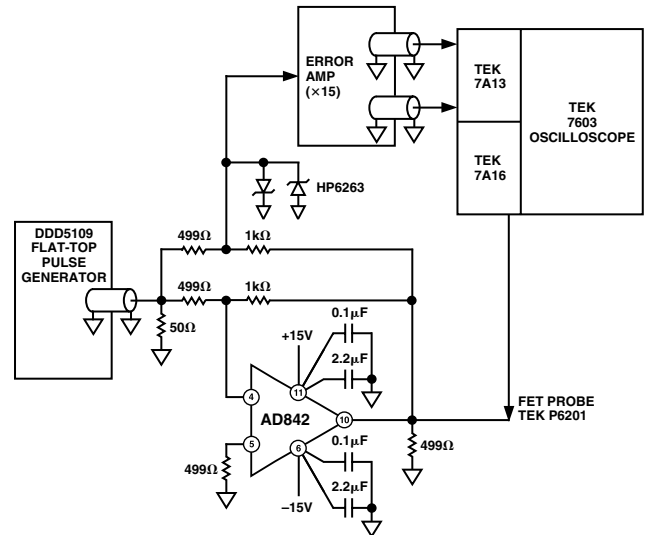

Figure 23. Settling Time Test Circuit

Figure 23 shows how measurement of the AD842's 0.01% settling in 100 ns was accomplished by amplifying the error signal from a false summing junction with a very high-speed proprietary hybrid error amplifier specially designed to enable testing of small settling errors. The device under test was driving a 300 Ω load. The input to the error amp is clamped in order to avoid possible problems associated with the overdrive recovery of the oscilloscope input amplifier. The error amp gains the error from the false summing junction by 15, and it contains a gain vernier to fine trim the gain.

Figure 24 shows the "long term" stability of the settling characteristics of the AD842 output after a 10 V step. There is no evidence of settling tails after the initial transient recovery time. The use of a junction isolated process, together with careful layout, avoids these problems by minimizing the effects of transistor isolation capacitance discharge and thermally induced shifts in circuit operating points. These problems do not occur even under high output current conditions.

# AD842

## GROUNDING AND BYPASSING

In designing practical circuits with the AD842, the user must remember that whenever high frequencies are involved, some

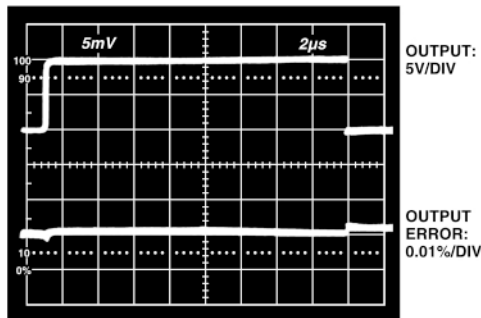

Figure 24. AD842 Settling Demonstrating No Settling Tails

special precautions are in order. Circuits must be built with short interconnect leads. Large ground planes should be used whenever possible to provide a low resistance, low inductance circuit path, as well as minimizing the effects of high frequency coupling. Sockets should be avoided because the increased interlead capacitance can degrade bandwidth.

Feedback resistors should be of low enough value to assure that the time constant formed with the circuit capacitances will not limit the amplifier performance. Resistor values of less than 5 kΩ are recommended. If a larger resistor must be used, a small (<10 pF) feedback capacitor connected in parallel with the feedback resistor,  $R_F$ , may be used to compensate for these stray capacitances and optimize the dynamic performance of the amplifier in the particular application.

Power supply leads should be bypassed to ground as close as possible to the amplifier pins. A 2.2 μF capacitor in parallel with a 0.1 μF ceramic disk capacitor is recommended.

## CAPACITIVE LOAD DRIVING ABILITY

Like all wideband amplifiers, the AD842 is sensitive to capacitive loading. The AD842 is designed to drive capacitive loads of up to 20 pF without degradation of its rated performance. Capacitive loads of greater than 20 pF will decrease the dynamic performance of the part although instability should not occur unless the load exceeds 100 pF.

## USING A HEAT SINK

The AD842 draws less quiescent power than most precision high speed amplifiers and is specified for operation without a heat sink. However, when driving low impedance loads, the current to the load can be 10 times the quiescent current. This will create a noticeable temperature rise. Improved performance can be achieved by using a small heat sink such as the Aavid Engineering #602B.

## TERMINATED LINE DRIVER

The AD842 is optimized for high speed line driver applications. Figure 25 shows the AD842 driving a doubly terminated cable in a gain-of-2 follower configuration. The AD842 maintains a typical slew rate of 375 V/μs, which means it can drive a ±10 V, 6.0 MHz signal or a ±3 V, 19.9 MHz signal.

The termination resistor,  $R_T$ , (when equal to the characteristic impedance of the cable) minimizes reflections from the far end of the cable. A back-termination resistor ( $R_{BT}$ , also equal to the characteristic impedance of the cable) may be placed between the AD842 output and the cable in order to damp any stray signals caused by a mismatch between  $R_T$  and the cable's characteristic impedance. This will result in a "cleaner" signal. With this circuit, the voltage on the line equals  $V_{IN}$  because one half of  $V_{OUT}$  is dropped across  $R_{BT}$ .

The AD842 has ±100 mA minimum output current and, therefore, can drive ±5 V into a 50 Ω cable.

The feedback resistors,  $R_1$  and  $R_2$ , must be chosen carefully. Large value resistors are desirable in order to limit the amount of current drawn from the amplifier output. But large resistors can cause amplifier instability because the parallel resistance  $R_1 || R_2$  combines with the input capacitance (typically 2–5 pF) to create an additional pole. Also, the voltage noise of the AD842 is equivalent to a 5 kΩ resistor, so large resistors can significantly increase the system noise. Resistor values of 1 kΩ or 2 kΩ are recommended.

If termination is not used, cables appear as capacitive loads and can be decoupled from the AD842 by a resistor in series with the output.

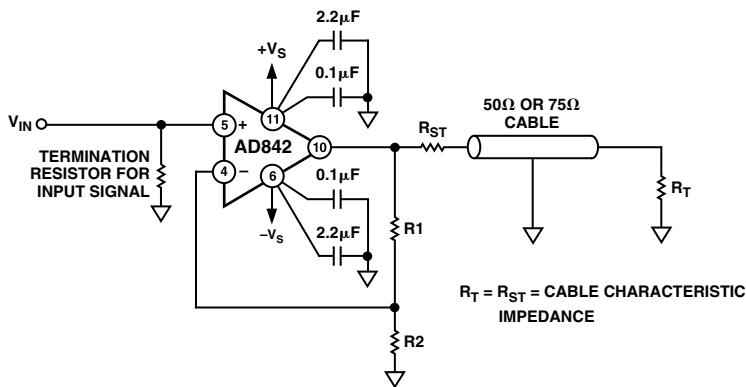

Figure 25. Line Driver Configuration



**OVERDRIVE RECOVERY**

Figure 26 shows the overdrive recovery capability of the AD842. Typical recovery time is 80 ns from negative overdrive and 400 ns from positive overdrive.

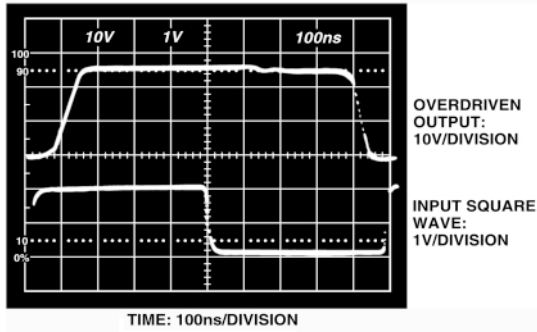

Figure 26. Overdrive Recovery

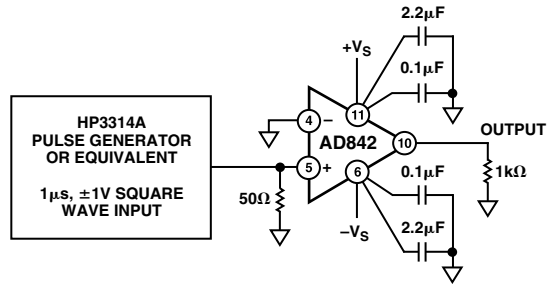

Figure 27. Overdrive Recovery Test Circuit

# AD842

## OUTLINE DIMENSIONS

Dimensions shown in inches and (mm).

**14-Lead Plastic Package  
(N-14)**

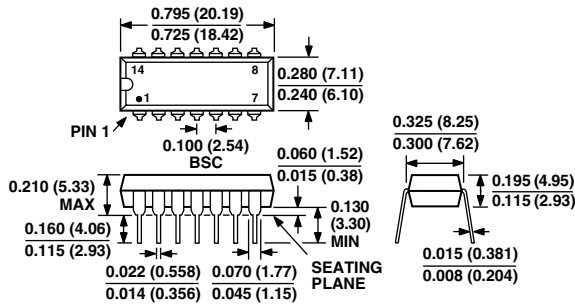

**14-Lead Cerdip Package  
(Q-14)**

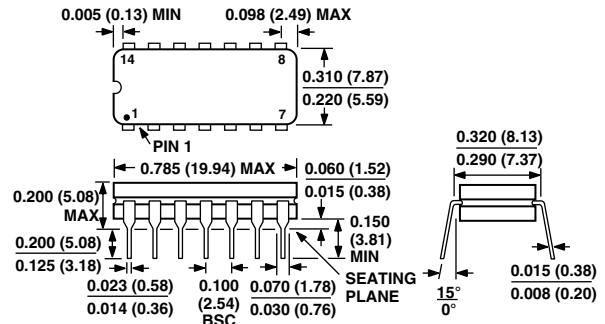

**16-Lead SOIC Package  
(R-16)**

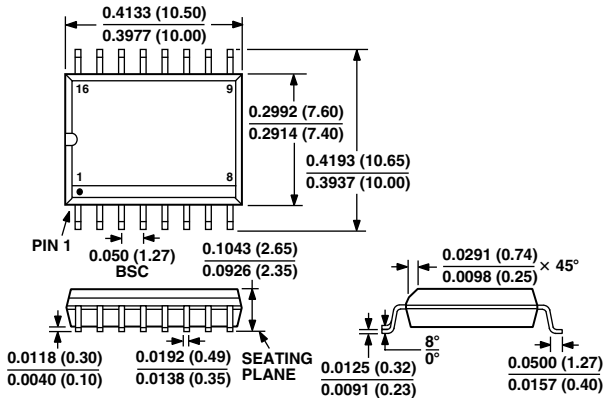

**20-Terminal Leadless Ceramic Chip Carrier Package  
(E-20A)**

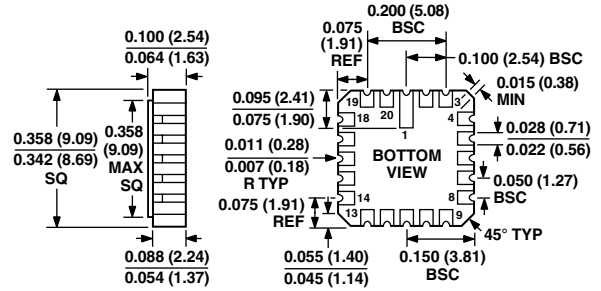

**12-Lead Metal Can Package  
(TO-8 Style)**

