

CLC414

Quad, Low-Power Monolithic Op Amp

General Description

The CLC414 is a low-power, quad, monolithic operational amplifier designed for intermediate-gain applications where power and cost per channel are of primary concern. Benefiting from National's current feedback architecture, the CLC414 offers a gain range of ± 1 to ± 10 while providing stable, oscillation-free operation without external compensation, even at unity gain.

Operating from $\pm 5V$ supplies, the CLC414 consumes only 25mW of power per channel, yet maintains a 90MHz small-signal bandwidth and a 1000V/ μs slew rate. The CLC414 also provides wide channel isolation with its 70dB crosstalk (input referred at 5MHz). Applications requiring a high-density solution to high-speed amplification such as active filters and instrumentation diff amps will benefit from the CLC414's four integrated, wideband op amps in one 14-pin package.

Commercial remote-sensing applications and battery-powered radio transceivers requiring high-performance, low-power amplifiers will find the CLC414 to be an attractive, cost-effective solution. In composite video switching and distribution applications, the CLC414 offers differential gain and phase performance of 0.1%, 0.12° at 3.58MHz.

The lower power CLC414 and the wideband CLC415 are quad versions of the CLC406. Both of these quads afford the designer lower power consumption and lower cost per channel with the additional benefit of requiring less board space per amplifier.

Constructed using an advanced, complementary bipolar process and National's proven current feedback architectures, the CLC414 is available in several versions to meet a variety of requirements.

CLC414AJP	-40°C to +85°C	14-pin plastic DIP
CLC414AJE	-40°C to +85°C	14-pin plastic SOIC
CLC414ALC	-40°C to +85°C	dice
CLC414A8B	-55°C to +125°C	14-pin hermetic CERDIP, MIL-STD-883, Level B

DESC SMD number: 5962-91693

Features

- 90MHz small signal bandwidth
- 2mA quiescent current per amplifier
- 70dB channel isolation @ 5MHz
- 0.1%/0.12° differential gain/phase
- 16ns settling to 0.1%
- 100V/ μs slew rate
- 3.3ns rise and fall time ($2V_{pp}$)
- 70mA output current

Applications

- Composite video distribution amps
- HDTV amplifiers
- RGB-video amplifiers
- CCD signal processing
- Active filters
- Instrumentation diff. amps
- General purpose high density requirements

Small Signal Pulse Response

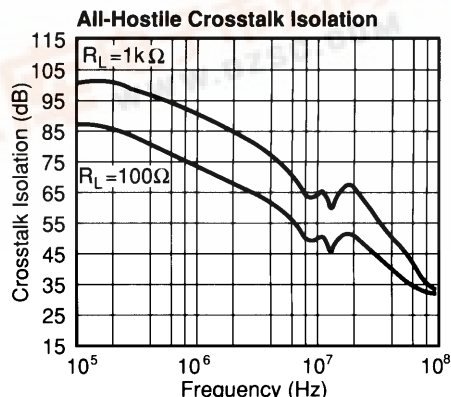
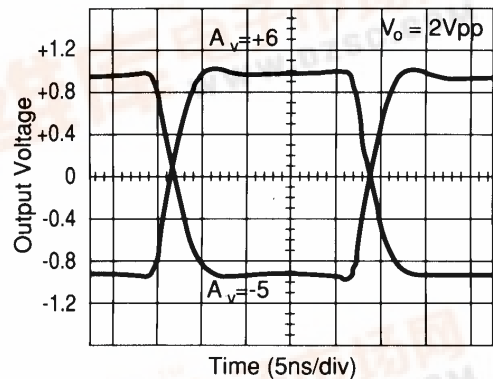

Pinout
DIP & SOIC

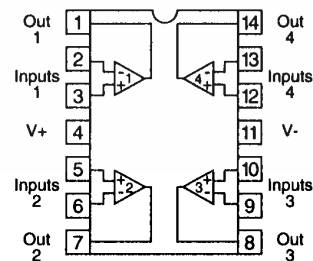

CLC414
Quad, Low-Power Monolithic Op Amp

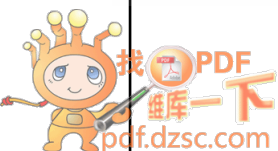

CLC414 Electrical Characteristics ($A_v = +6$, $V_{cc} = \pm 5V$, $R_L = 100\Omega$, $R_f = 500\Omega$; unless specified)

PARAMETERS	CONDITIONS	TYP	MAX & MIN RATINGS				UNITS	SYMBOL
			-40°C	+25°C	+85°C			
Ambient Temperature	CLC414AJ	+25°C	-40°C	+25°C	+85°C			
FREQUENCY DOMAIN RESPONSE								
-3dB bandwidth	$V_{out} < 2V_{pp}$	90	>60	>60	>45	MHz	SSBW	
	$V_{out} < 5V_{pp}$	55	>35	>40	>35	MHz	LSBW	
gain flatness	$V_{out} < 2V_{pp}$							
peaking	DC to 15MHz	0	<0.15	<0.15	<0.15	dB	GFPL	
peaking	>15MHz	0	<0.3	<0.3	<0.3	dB	GFPH	
rolloff	DC to 30MHz	0.3	<1.0	<1.0	<1.5	dB	GFR	
linear phase deviation	DC to 30MHz	0.8	<1.2	<1.2	<1.5	°	LPD	
differential gain ($A_v = +2$)	150Ω load, 3.58MHz	0.10	<0.15	<0.20	<0.25	%	DG1	
	4.43MHz	0.12	<0.20	<0.25	<0.30	%	DG2	
differential phase ($A_v = +2$)	150Ω load, 3.58MHz	0.12	<0.15	<0.20	<0.50	°	DP1	
	4.43MHz	0.15	<0.20	<0.25	<0.60	°	DP2	
crosstalk	input referred	60	<58	<58	<56	dB	XT	
	input referred	70	<63	<63	<61	dB	CXT	
TIME DOMAIN RESPONSE								
rise and fall time	2V step	3.3	<5.0	<5.0	<6.5	ns	TRS	
	5V step	4.0	<7.0	<6.0	<7.0	ns	TRL	
settling time to 0.1%	2V step	16	<24	<24	<30	ns	TS1	
to 0.02%	2V step	60	<80	<80	<100	ns	TS2	
overshoot	2V step	5	<10	<10	<10	%	OS	
slew rate		1000	>600	>600	>480	V/μs	SR	
DISTORTION AND NOISE RESPONSE								
2nd harmonic distortion	$2V_{pp}$, 5MHz	-47	<-41	<-41	<-37	dBc	HD2	
3rd harmonic distortion	$2V_{pp}$, 5MHz	-55	<-47	<-47	<-45	dBc	HD3	
equivalent noise input								
non-inverting voltage	>1MHz	4.2	<5.0	<5.0	<5.5	nV/√Hz	VN	
inverting current	>1MHz	9.8	<11.8	<11.8	<13.0	pA/√Hz	ICN	
non-inverting current	>1MHz	1.3	<1.6	<1.6	<1.8	pA/√Hz	NCN	
total noise floor	>1MHz	-154	<-153	<-153	<-152	dBm _{1Hz}	SNF	
total integrated noise	>1MHz to 75MHz	37	<44	<44	<48	μV	INV	
STATIC, DC PERFORMANCE								
*input offset voltage		2	<10.5	<6	<14	mV	VIO	
average temperature coefficient		30	<80	—	<80	μV/°C	DVIO	
*input bias current	non-inverting	1	<10	<5	<5	μA	IBN	
average temperature coefficient		20	<75	—	<30	nA/°C	DIBN	
*input bias current	inverting	2	<20	<6	<10	μA	IBI	
average temperature coefficient		20	<140	—	<75	nA/°C	DIBI	
power supply rejection ratio		50	>46	>46	>44	dB	PSRR	
common mode rejection ratio		50	>45	>45	>43	dB	CMRR	
*supply current, all channels	no load	10	<11.5	<11.5	<11.5	mA	ICC	
MISCELLANEOUS PERFORMANCE								
non-inverting input resistance		2000	>500	>1000	>1000	kΩ	RIN	
non-inverting input capacitance		1.0	<2.0	<2.0	<2.0	pF	CIN	
output impedance	DC	0.2	<0.6	<0.3	<0.2	Ω	RO	
output voltage range	$R_L = 100\Omega$	±2.8	±2.5	±2.6	±2.7	V	VO	
common mode input range		±2.2	±1.4	±2.0	±2.0	V	CMIR	
output current		70	30	50	50	mA	IO	

Min/max ratings are based on product characterization and simulation. Individual parameters are tested as noted. Outgoing quality levels are determined from tested parameters.

Absolute Maximum Ratings

V_{cc}	±7V
I_{out}	output is short circuit protected to ground, however, maximum reliability is obtained if I_{out} does not exceed... 70mA
common mode input voltage	± V_{cc}
differential input voltage	±10V
maximum junction temperature	+150°C
operating temperature range	AJ: -40°C to +85°C
storage temperature range	-65°C to +150°C
lead temperature (soldering 10 sec)	+300°C
ESD rating (human body model)	<1000V

Miscellaneous Ratings

recommended gain range: ±1 to ±10
Notes: * AJ 100% tested at +25°C.

Package Thermal Resistance

Package	θ_{JC}	θ_{JA}
AJP	60°C/W	110°C/W
AJE	45°C/W	115°C/W

Reliability Information

Transistor count

152

CLC414 Typical Performance Characteristics ($T_A = 25^\circ$, $A_V = +6$, $V_{CC} = \pm 5V$, $R_L = 100\Omega$, $R_f = 500\Omega$)

Non-Inverting Frequency Response

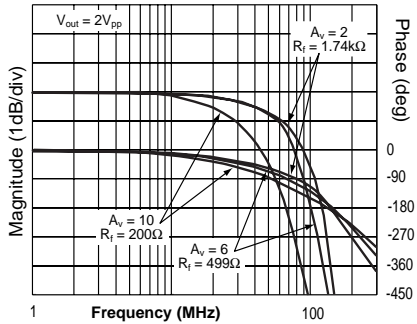

Inverting Frequency Response

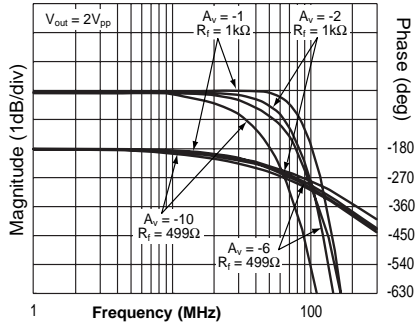

Frequency Response for Various R_L s

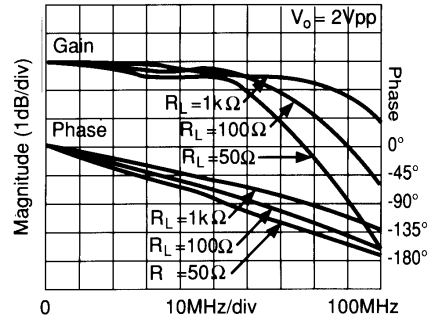

Small Signal Pulse Response

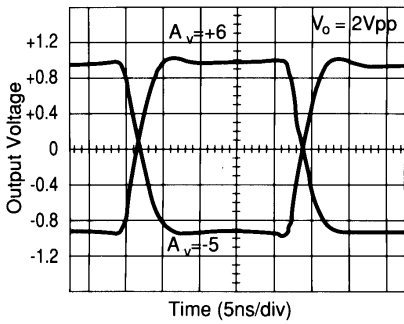

Short-Term Settling Time

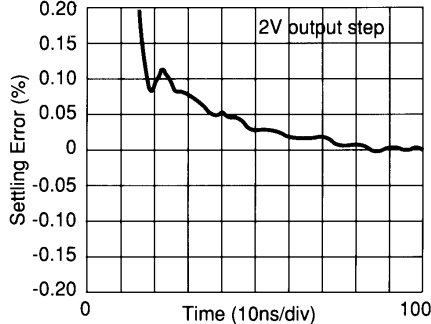

Long-Term Settling Time

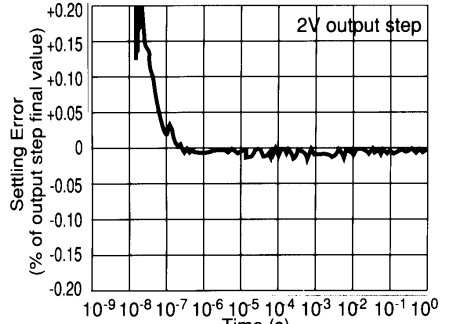

2nd and 3rd Harmonic Distortion

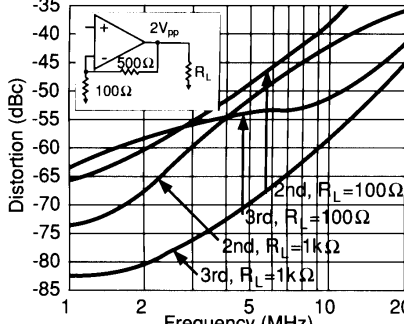

2-Tone, 3rd Order Spurious Levels

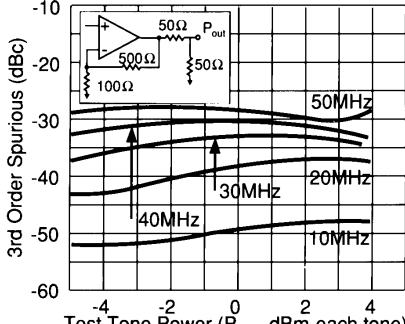

Settling Time vs. Capacitive Load

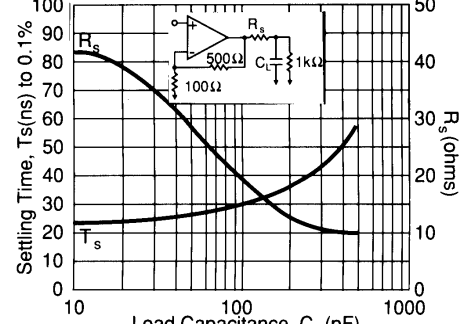

All-Hostile Crosstalk Isolation

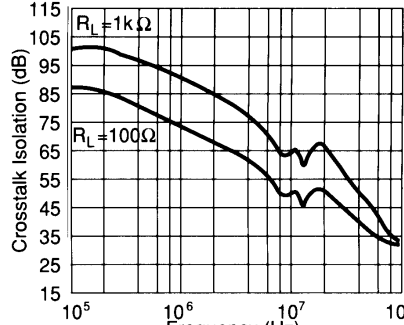

Most Susceptible Channel-Channel Pulse Coupling

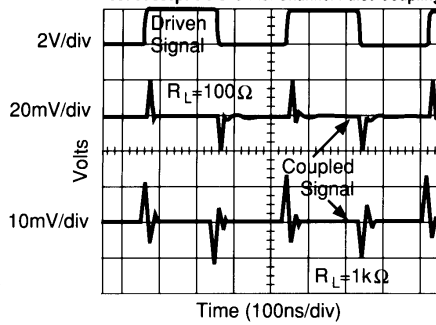

Differential Gain and Phase (4.43 MHz, $A_V = +2$)

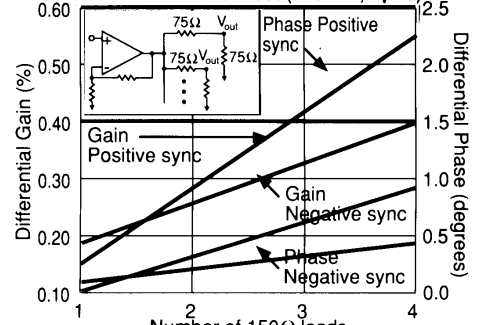

Equivalent Input Noise

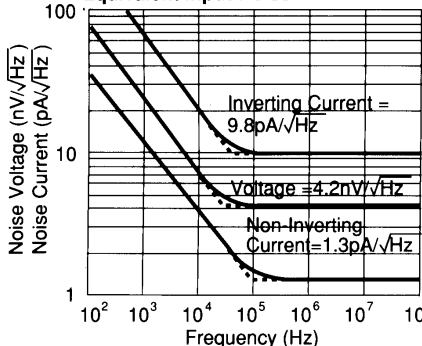

Open-Loop Transimpedance Gain, Z(s)

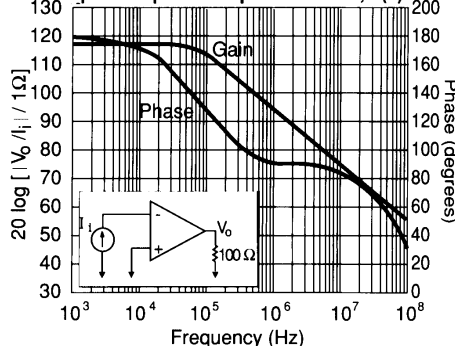

PSRR, CMRR, and Closed Loop R_o

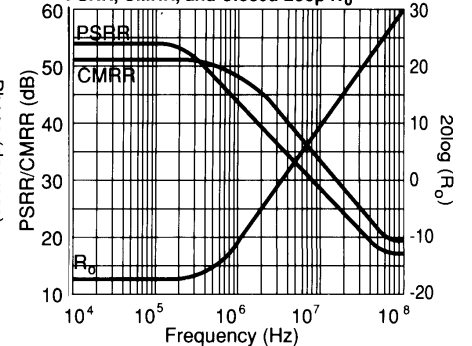

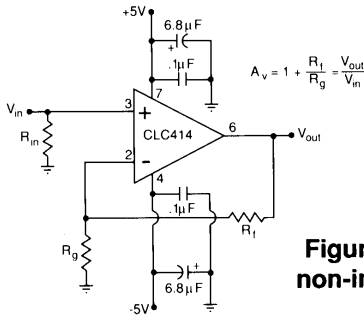

Figure 1: recommended non-inverting gain circuit

Feedback Resistor

The CLC414 achieves its exceptional AC performance while requiring very low quiescent power by using the current feedback topology and an internal slew rate enhancement circuit. The loop gain and frequency response for a current feedback op amp is predominantly set by the feedback resistor value. The CLC414 is optimized for a gain of +6 to use a 500Ω feedback resistor (use a 1kΩ R_f for maximally flat response at a gain of +2). Using lower values can lead to excessive ringing in the pulse response while a higher value will limit the bandwidth. Application Note OA-13 provides a more detailed discussion of choosing a feedback resistor. The equations found in this application note are to be considered a starting point for the determination of R_f at any gain. The value of input impedance for the CLC414 is approximately 250Ω. These equations do not account for parasitic capacitance at the inverting input nor across R_f . The plot found below entitled “Recommended R_f vs. Gain” offers values of R_f which will optimize the frequency response of the CLC414 over its ± 1 to ± 10 gain range. Unlike voltage feedback, current feedback op amps require a non-zero R_f for unity gain followers.

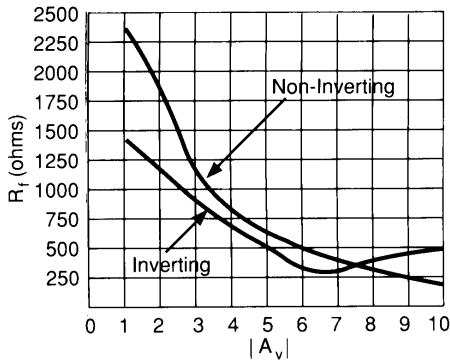

Figure 3: recommended R_f vs. gain

Unused Amplifiers

It is recommended that any unused amplifiers in the quad package be connected as unity gain followers ($R_f = 500\Omega$) with the non-inverting input tied to ground through a 50Ω resistor.

Slew Rate and Harmonic Distortion

Please see the application information for the CLC406.

Differential Gain and Phase

Differential gain and phase performance specifications are common to composite video distribution applications. These specifications refer to the change in small signal gain and phase of the color subcarrier frequency (4.43MHz for PAL composite video) as the amplifier output is swept over a range of DC voltages. Application Note OA-08 provides an additional discussion of differential gain and phase measurements.

Non-inverting Source Impedance

For best operation, the DC source impedance looking out of the non-inverting input should be less than 3kΩ but greater than 20Ω. Parasitic self oscillations may occur in

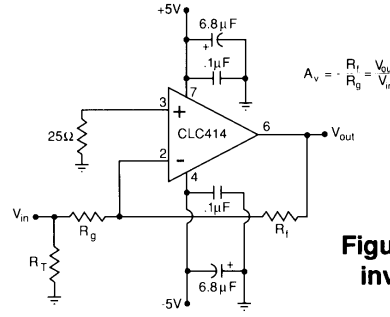

Figure 2: recommended inverting gain circuit

Select R_T to yield desired $R_{in} = R_T || R_g$

the input transistors if the DC source impedance is out of this range. This impedance also acts as the gain for the non-inverting input bias and noise currents and therefore can become troublesome for high values of DC source impedance. The inverting configuration of Figure 2 shows a 25Ω resistor to ground on the non-inverting input which insures stability but does not provide bias current cancellation. The input bias currents are unrelated for a current feedback amplifier which eliminates the need for source impedance matching to achieve bias current cancellation.

DC Accuracy and Noise Calculation

Please refer to the application information for the CLC406.

Crosstalk

In any multi-channel integrated circuit there is an undesirable tendency for the signal in one channel to couple with and reproduce itself in the output of another channel. This effect is referred to as crosstalk. Crosstalk is expressed as channel separation or channel isolation which indicates the magnitude of this undesirable effect. This effect is measured by driving one or more channels and observing the output of the other undriven channel(s). The CLC414 plot page offers two different graphs detailing the effect of crosstalk over frequency. One plot entitled “All-Hostile Crosstalk Isolation” graphs all-hostile input-referred crosstalk. All-hostile crosstalk refers to the condition where three channels are driven simultaneously while observing the output of the undriven fourth channel. Input-referred implies that crosstalk is directly affected by gain and therefore a higher gain increases the crosstalk effect by a factor equal to that gain setting. The plot entitled “Most Susceptible Channel-to-Channel Pulse Coupling” describes the effect of crosstalk when one channel is driven with a 2V_{pp} pulse while the output of the most effected channel is observed.

Printed Circuit Layout

As with any high speed component, a careful attention to the board layout is necessary for optimum performance. Of particular importance is the careful control of parasitic capacitances on the output pin. As the output impedance plot shows, the closed loop output for the CLC414 eventually becomes inductive as the loop gain rolls off with increasing frequency. Direct capacitive loading on the output pin can quickly lead to peaking in the frequency response, overshoot in the pulse response, ringing or even sustained oscillations. The “Settling Time vs. Capacitive Load” plot should be used as a starting point for the selection of a series output resistor when a capacitive load must be driven. A quad amplifier will require careful attention to signal routing in order to minimize the effects of crosstalk. Signal coupling through the power supplies can be reduced with bypass capacitors placed close to the device supply pins.

Evaluation Board

Evaluation PC boards (part number 730024 for through-hole and 730031 for SOIC) for the CLC414 are available.

This page intentionally left blank.

Customer Design Applications Support

National Semiconductor is committed to design excellence. For sales, literature and technical support, call the National Semiconductor Customer Response Group at **1-800-272-9959** or fax **1-800-737-7018**.

Life Support Policy

National's products are not authorized for use as critical components in life support devices or systems without the express written approval of the president of National Semiconductor Corporation. As used herein:

1. Life support devices or systems are devices or systems which, a) are intended for surgical implant into the body, or b) support or sustain life, and whose failure to perform, when properly used in accordance with instructions for use provided in the labeling, can be reasonably expected to result in a significant injury to the user.
2. A critical component is any component of a life support device or system whose failure to perform can be reasonably expected to cause the failure of the life support device or system, or to affect its safety or effectiveness.



National Semiconductor Corporation

1111 West Bardin Road
Arlington, TX 76017
Tel: 1(800) 272-9959
Fax: 1(800) 737-7018

National Semiconductor Europe

Fax: (+49) 0-180-530 85 86
E-mail: europe.support.nsc.com
Deutsch Tel: (+49) 0-180-530 85 85
English Tel: (+49) 0-180-532 78 32
Francais Tel: (+49) 0-180-532 93 58
Italiano Tel: (+49) 0-180-534 16 80

National Semiconductor Hong Kong Ltd.

2501 Miramar Tower
1-23 Kimberley Road
Tsimshatsui, Kowloon
Hong Kong
Tel: (852) 2737-1600
Fax: (852) 2736-9960

National Semiconductor Japan Ltd.

Tel: 81-043-299-2309
Fax: 81-043-299-2408