

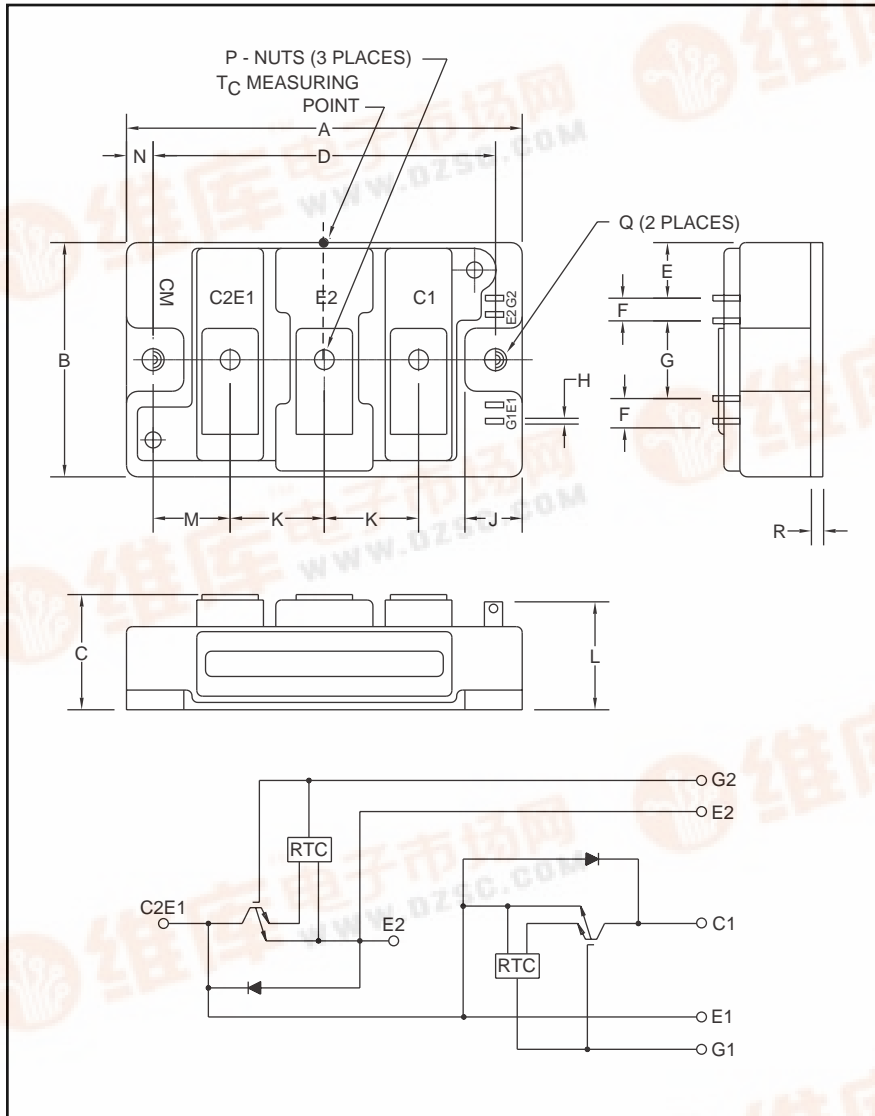

Powerex, Inc., 200 E. Hillis Street, Youngwood, Pennsylvania 15697-1800 (724) 925-7272

## CM150DU-12F

### Trench Gate Design Dual IGBTMOD™ 150 Amperes/600 Volts



Outline Drawing and Circuit Diagram

Dimensions	Inches	Millimeters
A	3.70	94.0
B	1.89	48.0
C	1.18 +0.04/-0.02	30.0 +1.0/-0.5
D	3.15±0.01	80.0±0.25
E	0.43	11.0
F	0.16	4.0
G	0.71	18.0
	0.02	0.5

Dimensions	Inches	Millimeters
J	0.53	13.5
K	0.91	23.0
L	1.13	28.7
M	0.67	17.0
N	0.28	7.0
P	M6.5	M6.5
Q	0.26 Dia.	6.5 Dia.
R	0.16	4.0



#### Description:

Powerex IGBTMOD™ Modules are designed for use in switching applications. Each module consists of two IGBT Transistors in a half-bridge configuration with each transistor having a reverse-connected super-fast recovery free-wheel diode. All components and interconnects are isolated from the heat sinking baseplate, offering simplified system assembly and thermal management.

#### Features:

- Low Drive Power
- Low  $V_{CE(sat)}$
- Discrete Super-Fast Recovery Free-Wheel Diode
- Isolated Baseplate for Easy Heat Sinking

#### Applications:

- AC Motor Control
- UPS
- Battery Powered Supplies

#### Ordering Information:

Example: Select the complete module number you desire from the table - i.e. CM150DU-12F is a 600V ( $V_{CES}$ ), 150 Ampere Dual IGBTMOD™ Power Module.

Type	Current Rating Amperes	$V_{CES}$ Volts (x 50)
CM	150	12





Powerex, Inc., 200 E. Hillis Street, Youngwood, Pennsylvania 15697-1800 (724) 925-7272

**CM150DU-12F**  
**Trench Gate Design Dual IGBTMOD™**  
 150 Amperes/600 Volts

**Absolute Maximum Ratings,  $T_j = 25\text{ °C}$  unless otherwise specified**

Ratings	Symbol	CM150DU-12F	Units
Junction Temperature	$T_j$	-40 to 150	°C
Storage Temperature	$T_{stg}$	-40 to 125	°C
Collector-Emitter Voltage (G-E SHORT)	$V_{CES}$	600	Volts
Gate-Emitter Voltage (C-E SHORT)	$V_{GES}$	±20	Volts
Collector Current ( $T_c = 25\text{ °C}$ )	$I_C$	150	Amperes
Peak Collector Current	$I_{CM}$	300*	Amperes
Emitter Current** ( $T_c = 25\text{ °C}$ )	$I_E$	150	Amperes
Peak Emitter Current**	$I_{EM}$	300*	Amperes
Maximum Collector Dissipation ( $T_c = 25\text{ °C}$ , $T_j \leq 150\text{ °C}$ )	$P_C$	520	Watts
Mounting Torque, M5 Main Terminal	–	31	in-lb
Mounting Torque, M6 Mounting	–	40	in-lb
Weight	–	310	Grams
Isolation Voltage (Main Terminal to Baseplate, AC 1 min.)	$V_{iso}$	2500	Volts

**Static Electrical Characteristics,  $T_j = 25\text{ °C}$  unless otherwise specified**

Characteristics	Symbol	Test Conditions	Min.	Typ.	Max.	Units
Collector-Cutoff Current	$I_{CES}$	$V_{CE} = V_{CES}$ , $V_{GE} = 0V$	–	–	1	mA
Gate Leakage Current	$I_{GES}$	$V_{GE} = V_{GES}$ , $V_{CE} = 0V$	–	–	20	μA
Gate-Emitter Threshold Voltage	$V_{GE(th)}$	$I_C = 15mA$ , $V_{CE} = 10V$	5	6	7	Volts
Collector-Emitter Saturation Voltage	$V_{CE(sat)}$	$I_C = 150A$ , $V_{GE} = 15V$ , $T_j = 25\text{ °C}$	–	1.6	2.2	Volts
		$I_C = 150A$ , $V_{GE} = 15V$ , $T_j = 125\text{ °C}$	–	1.6	–	Volts
Total Gate Charge	$Q_G$	$V_{CC} = 300V$ , $I_C = 150A$ , $V_{GE} = 15V$	–	930	–	nC
Emitter-Collector Voltage**	$V_{EC}$	$I_E = 150A$ , $V_{GE} = 0V$	–	–	2.6	Volts

\* Pulse width and repetition rate should be such that the device junction temperature ( $T_j$ ) does not exceed  $T_{j(max)}$  rating.

\*\* Represents characteristics of the anti-parallel, emitter-to-collector free-wheel diode (FWDI).



Powerex, Inc., 200 E. Hillis Street, Youngwood, Pennsylvania 15697-1800 (724) 925-7272

**CM150DU-12F**  
**Trench Gate Design Dual IGBTMOD™**  
 150 Amperes/600 Volts

**Dynamic Electrical Characteristics,  $T_j = 25\text{ }^\circ\text{C}$  unless otherwise specified**

Characteristics	Symbol	Test Conditions	Min.	Typ.	Max.	Units
Input Capacitance	$C_{ies}$		–	–	41	nf
Output Capacitance	$C_{oes}$	$V_{CE} = 10V, V_{GE} = 0V$	–	–	2.7	nf
Reverse Transfer Capacitance	$C_{res}$		–	–	1.5	nf
Inductive	Turn-on Delay Time	$V_{CC} = 300V, I_C = 150A,$ $V_{GE1} = V_{GE2} = 15V,$ $R_G = 4.2\Omega,$	–	–	120	ns
Load	Rise Time					
Switch	Turn-off Delay Time	Inductive Load	–	–	350	ns
Times	Fall Time					
Diode Reverse Recovery Time**	$t_{rr}$	Switching Operation	–	–	150	ns
Diode Reverse Recovery Charge**	$Q_{rr}$	$I_E = 150A$	–	2.8	–	$\mu C$

**Thermal and Mechanical Characteristics,  $T_j = 25\text{ }^\circ\text{C}$  unless otherwise specified**

Characteristics	Symbol	Test Conditions	Min.	Typ.	Max.	Units
Thermal Resistance, Junction to Case	$R_{th(j-c)Q}$	Per IGBT 1/2 Module, $T_C$ Reference Point per Outline Drawing	–	–	0.24	$^\circ\text{C/W}$
Thermal Resistance, Junction to Case	$R_{th(j-c)D}$	Per FWDi 1/2 Module, $T_C$ Reference Point per Outline Drawing	–	–	0.47	$^\circ\text{C/W}$
Thermal Resistance, Junction to Case	$R_{th(j-c)'Q}$	Per IGBT 1/2 Module, $T_C$ Reference Point Under Chip	–	0.16	–	$^\circ\text{C/W}$
Contact Thermal Resistance	$R_{th(c-f)}$	Per Module, Thermal Grease Applied	–	0.035	–	$^\circ\text{C/W}$

\*\* Represents characteristics of the anti-parallel, emitter-to-collector free-wheel diode (FWDi).



Powerex, Inc., 200 E. Hillis Street, Youngwood, Pennsylvania 15697-1800 (724) 925-7272

**CM150DU-12F**  
**Trench Gate Design Dual IGBTMOD™**  
 150 Amperes/600 Volts

**OUTPUT CHARACTERISTICS (TYPICAL)**

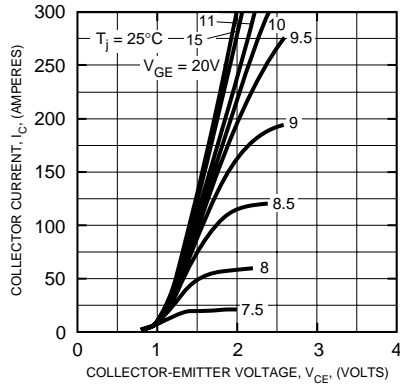

**COLLECTOR-EMITTER SATURATION VOLTAGE CHARACTERISTICS (TYPICAL)**

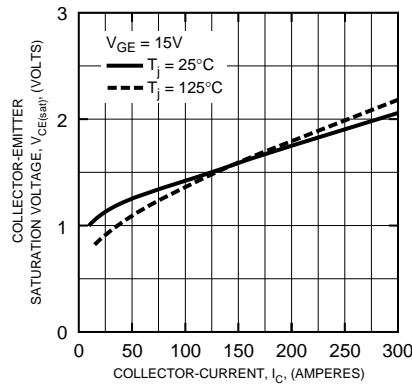

**COLLECTOR-EMITTER SATURATION VOLTAGE CHARACTERISTICS (TYPICAL)**

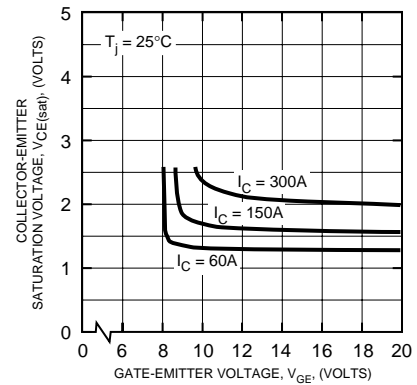

**FREE-WHEEL DIODE FORWARD CHARACTERISTICS (TYPICAL)**

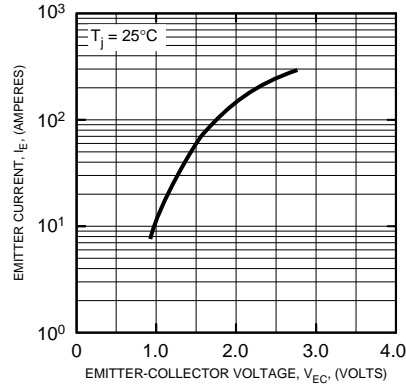

**CAPACITANCE VS. VCE (TYPICAL)**

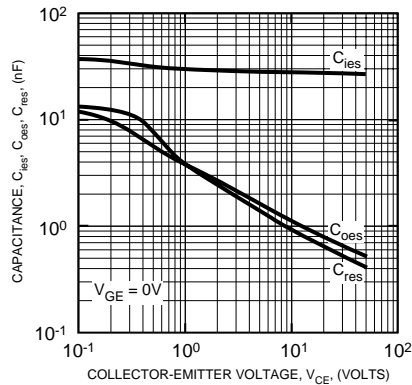

**HALF-BRIDGE SWITCHING CHARACTERISTICS (TYPICAL)**

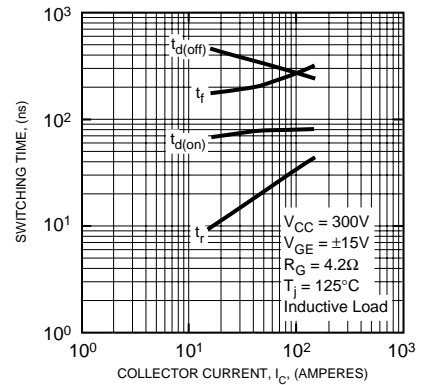

**REVERSE RECOVERY CHARACTERISTICS (TYPICAL)**

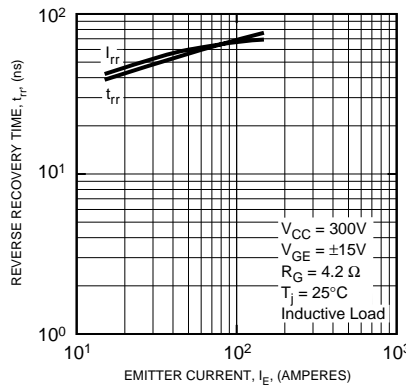

**GATE CHARGE, VGE**

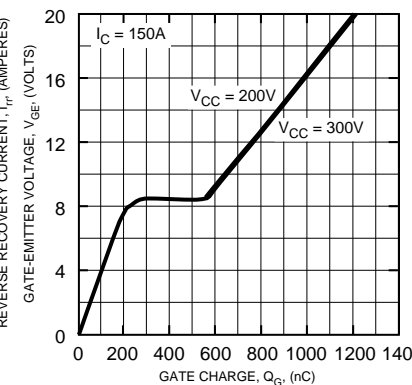

**TRANSIENT THERMAL IMPEDANCE CHARACTERISTICS (IGBT & FWDi)**

