

MITSUBISHI IGBT MODULES

CM200DU-24NFH

HIGH POWER SWITCHING USE

CM200DU-24NFH



- IC 200A
- VCES 1200V
- Insulated Type
- 2-elements in a pack

APPLICATION

High frequency switching use (30kHz to 60kHz).

Gradient amplifier, Induction heating, power supply, etc.

OUTLINE DRAWING & CIRCUIT DIAGRAM

Dimensions in mm

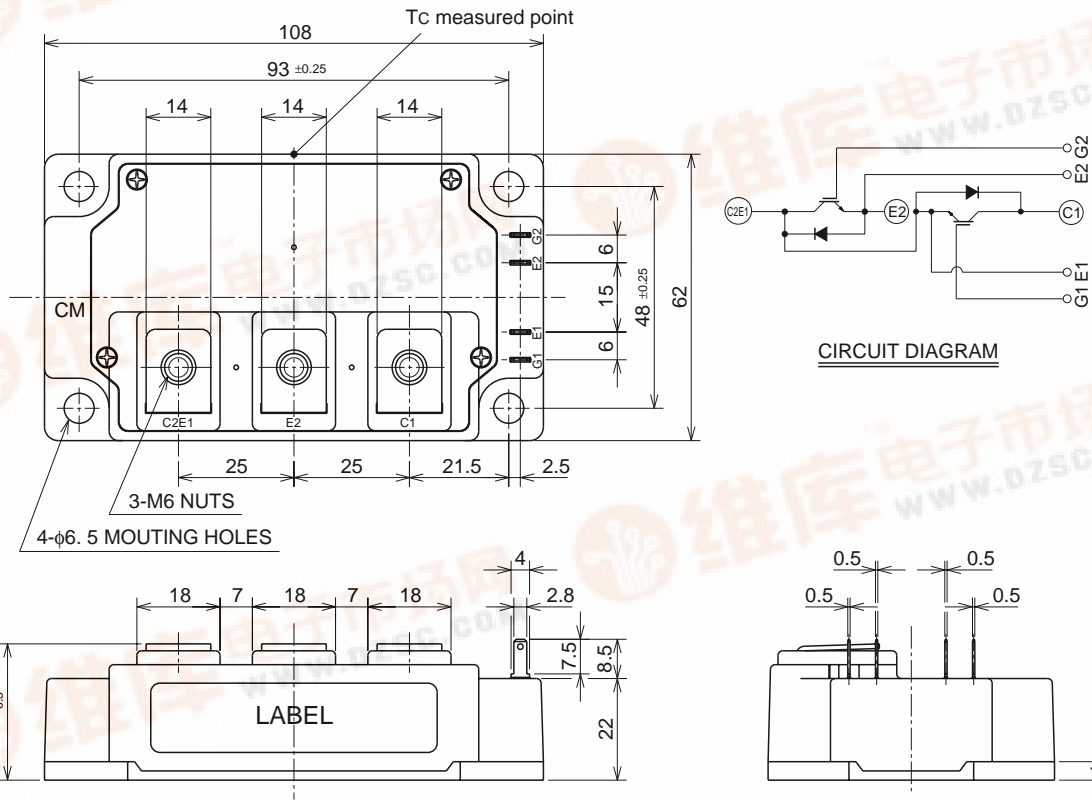

CM200DU-24NFH

HIGH POWER SWITCHING USE

MAXIMUM RATINGS (T_j = 25°C)

Symbol	Parameter	Conditions	Ratings	Unit
V _{CES}	Collector-emitter voltage	G-E Short	1200	V
V _{GES}	Gate-emitter voltage	C-E Short	±20	V
I _C	Collector current	Operation (Note 2)	200	A
I _{CM}		Pulse (Note 2)	400	A
I _E (Note 1)	Emitter current	Operation (Note 2)	200	A
I _{EM} (Note 1)		Pulse (Note 2)	400	A
P _C (Note 3)	Maximum collector dissipation	T _C = 25°C	830	W
P _C ' (Note 3)	Maximum collector dissipation	T _C ' = 25°C ⁴	1300	W
T _j	Junction temperature		-40 ~ +150	°C
T _{stg}	Storage temperature		-40 ~ +125	°C
V _{iso}	Isolation voltage	Main Terminal to base plate, AC 1 min.	2500	V
—	Mounting torque	Main Terminal M6	3.5 ~ 4.5	N • m
—		Mounting holes M6	3.5 ~ 4.5	N • m
—	Weight	Typical value	400	g

ELECTRICAL CHARACTERISTICS (T_j = 25°C)

Symbol	Parameter	Test conditions	Limits			Unit
			Min.	Typ.	Max.	
I _{CES}	Collector cutoff current	V _{CE} = V _{CES} , V _{GE} = 0V	—	—	1	mA
V _{GE(th)}	Gate-emitter threshold voltage	I _C = 20mA, V _{CE} = 10V	4.5	6	7.5	V
I _{GES}	Gate leakage current	V _{GE} = V _{GES} , V _{CE} = 0V	—	—	0.7	μA
V _{CE(sat)}	Collector-emitter saturation voltage (Note 4)	T _j = 25°C	—	5.0	6.5	V
		T _j = 125°C				
C _{ies}	Input capacitance	V _{CE} = 10V V _{GE} = 0V	—	—	32	nF
C _{oes}	Output capacitance		—	—	2.7	nF
C _{res}	Reverse transfer capacitance		—	—	0.6	nF
Q _G	Total gate charge	V _{CC} = 600V, I _C = 200A, V _{GE} = 15V	—	900	—	nC
t _{d(on)}	Turn-on delay time	V _{CC} = 600V, I _C = 200A V _{GE1} = V _{GE2} = 15V R _G = 1.6Ω, Inductive load switching operation	—	—	300	ns
t _r	Turn-on rise time		—	—	80	ns
t _{d(off)}	Turn-off delay time		—	—	500	ns
t _f	Turn-off fall time		—	—	150	ns
t _{rr} (Note 1)	Reverse recovery time	I _E = 200A	—	—	250	ns
Q _{rr} (Note 1)	Reverse recovery charge		—	7.5	—	μC
V _{EC} (Note 1)	Emitter-collector voltage	I _E = 200A, V _{GE} = 0V	—	—	3.5	V
R _{th(j-c)Q}	Thermal resistance*1	IGBT part (1/2 module)	—	—	0.15	°C/W
R _{th(j-c)R}		FWDi part (1/2 module)	—	—	0.24	°C/W
R _{th(c-f)}	Contact thermal resistance	Case to fin, Thermal compound Applied*2 (1/2 module)	—	0.04	—	°C/W
R _{th(j-c)Q}	Thermal resistance*4	IGBT part (1/2 module)	—	—	0.095*3	°C/W
R _{th(j-c)R}		FWDi part (1/2 module)	—	—	0.14*3	°C/W
R _G	External gate resistance		1.6	—	16	Ω

*1 : T_C measured point is shown in page OUTLINE DRAWING.

*2 : Typical value is measured by using Shin-etsu Silicone "G-746".

*3 : If you use this value, R_{th(f-a)} should be measured just under the chips.

*4 : T_C' measured point is just under the chips.

Note 1. I_E, V_{EC}, t_{rr} & Q_{rr} represent characteristics of the anti-parallel, emitter to collector free-wheel diode (FWDi).

2. Pulse width and repetition rate should be such that the device junction temp. (T_j) does not exceed T_{jmax} rating.

3. Junction temperature (T_j) should not increase beyond 150°C.

4. No short circuit capability is designed.

CM200DU-24NFH

HIGH POWER SWITCHING USE

PERFORMANCE CURVES

OUTPUT CHARACTERISTICS (TYPICAL)

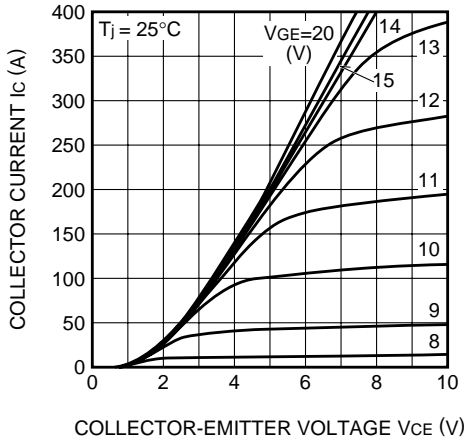

TRANSFER CHARACTERISTICS (TYPICAL)

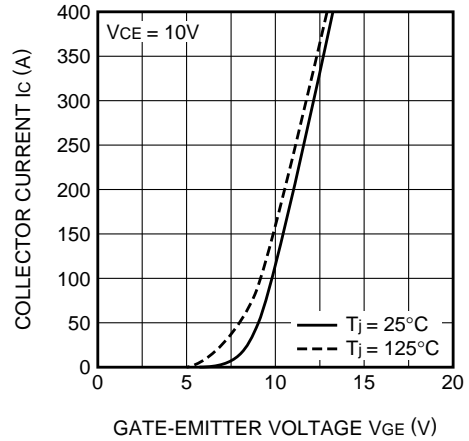

COLLECTOR-EMITTER SATURATION VOLTAGE CHARACTERISTICS (TYPICAL)

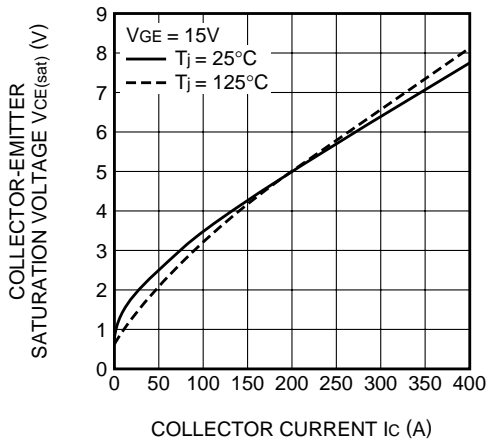

COLLECTOR-EMITTER SATURATION VOLTAGE CHARACTERISTICS (TYPICAL)

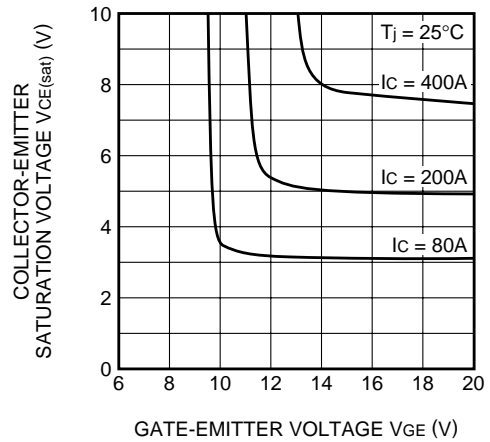

FREE-WHEEL DIODE FORWARD CHARACTERISTICS (TYPICAL)

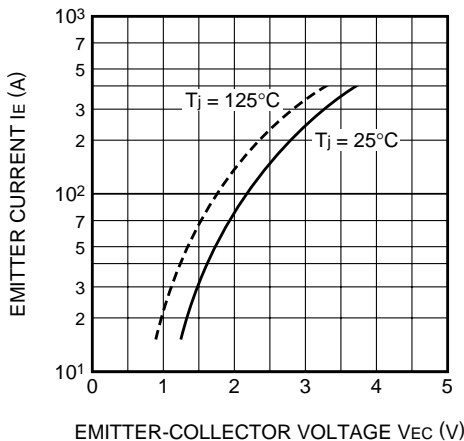

CAPACITANCE CHARACTERISTICS (TYPICAL)

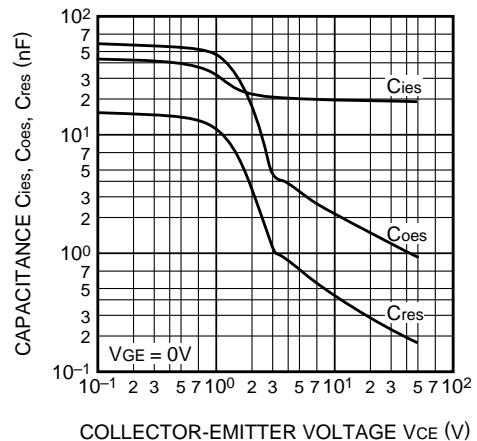

CM200DU-24NFH

HIGH POWER SWITCHING USE

HALF-BRIDGE SWITCHING TIME CHARACTERISTICS (TYPICAL)

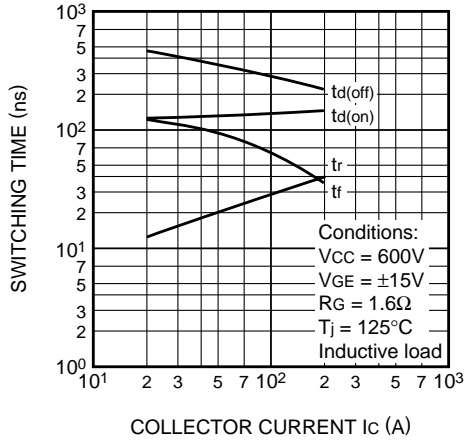

REVERSE RECOVERY CHARACTERISTICS OF FREE-WHEEL DIODE (TYPICAL)

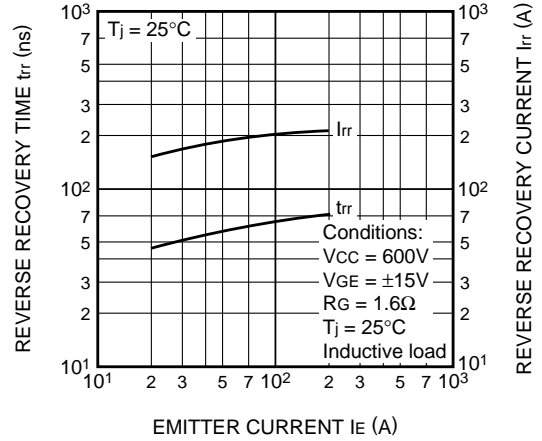

TRANSIENT THERMAL IMPEDANCE CHARACTERISTICS (IGBT part)

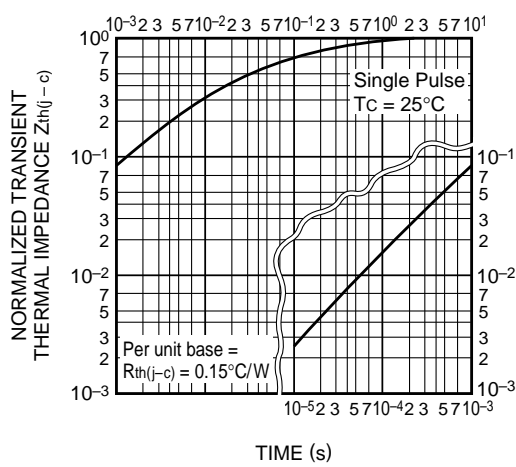

TRANSIENT THERMAL IMPEDANCE CHARACTERISTICS (FWDi part)

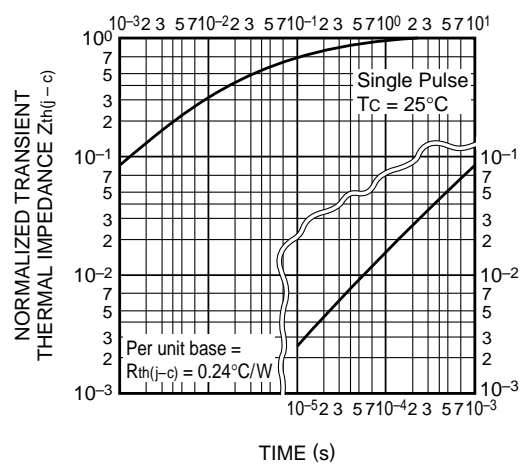

GATE CHARGE CHARACTERISTICS (TYPICAL)

