

## Micropower, 150mA Low Noise CMOS Regulator with Fast Response

### Features

- Available with 1.5V, 1.8V, 2.5V, 2.6V, 2.8V, 2.85V, 2.9V, 3.0V, 3.1V or 3.3V outputs
- Fast (60 $\mu$ s)  $V_{OUT}$  response when enabled
- Ultra low noise (35 $\mu$ V rms typ.)
- Delivers up to 150mA output current
- Very low dropout (150mV at 150mA)
- Low quiescent operating current (110 $\mu$ A)
- Stable with low-ESR ceramic capacitors
- "Zero" disable mode current consumption
- Thermal overload protection
- Foldback overload current protection
- -40°C to +85°C temperature operation
- Available in a 5-pin SOT23 and 5-bump Chip Scale Packages (CSP)
- Lead-free versions available

### Applications

- Wireless handsets, PDAs, MP3 players, digital cameras
- PCs and notebooks
- Graphics cards, set-top boxes
- Compact Flash memory cards
- Battery-powered devices
- PC cards

### Product Description

The CM3018 is a very low dropout, low noise regulator that delivers up to 150mA of load current at a fixed output voltage.

A dedicated control input (EN, Active High) provides power-up sequencing flexibility. When this input is taken low, the regulator is disabled. In this state, the supply current will drop to near zero. An internal discharge MOSFET resistance (300 $\Omega$ ) will force the output to ground whenever the device is disabled.

An optional bypass pin is provided for further improvement of noise performance and to maximize the power supply ripple rejection.

The CM3018 is fully protected, offering both overload current limiting and high temperature thermal shut-down.

The CM3018 is available in a tiny 5 lead SOT-23 package or a 5-bump CSP and is ideal for space critical applications. The CSP version of the CM3018 incorporates OptiGuard™ technology to provide increased reliability at assembly.

All versions of the CM3018 are now available with optional lead-free finishing.

### Typical Application Circuit

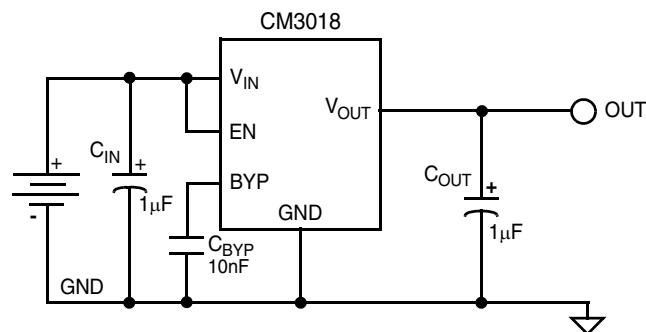

### Simplified Electrical Schematic

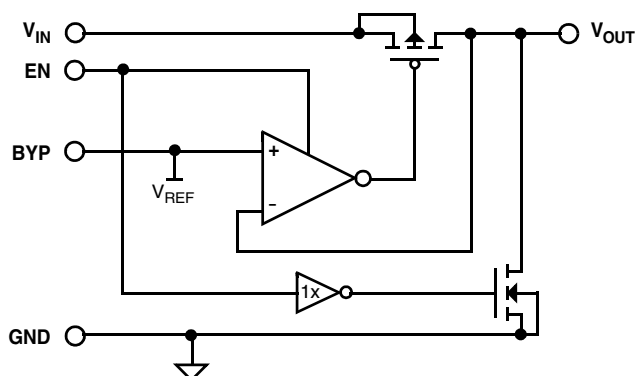

**Pin / Bump Descriptions**

PIN / BUMP DESCRIPTIONS			
SOT23-5 PIN	CSP BUMP	NAME	DESCRIPTION
1	C3	V <sub>IN</sub>	The input power supply for the regulator. If this input is within a few inches of the main supply filter, a capacitor may not be necessary. Otherwise an input filter capacitor of approximately 1μF will ensure adequate filtering.
2	B2	GND	The negative reference for all voltages.
3	A1	EN	A logic input control to enable the regulator output. When EN is asserted (logic high), it allows output regulation to commence. When EN is deasserted (logic low), the regulator pass transistor is forced into a high impedance mode, and an internal discharge resistance (300Ω) is applied to the output.
4	A3	BYP	This pin is connected to the internal voltage reference of the regulator. An external bypass capacitor C <sub>BYP</sub> of 10nF is recommended to improve the noise performance and to maximize the power supply ripple rejection.
5	C1	V <sub>OUT</sub>	The regulator voltage output used to power the load. A nominal output capacitor of 1μF is sufficient to minimize any transient disturbances under normal operating conditions. Additional output capacitance can be used to further improve transient load response.

**Package / Ordering Information**

**SOT23-5 Package**

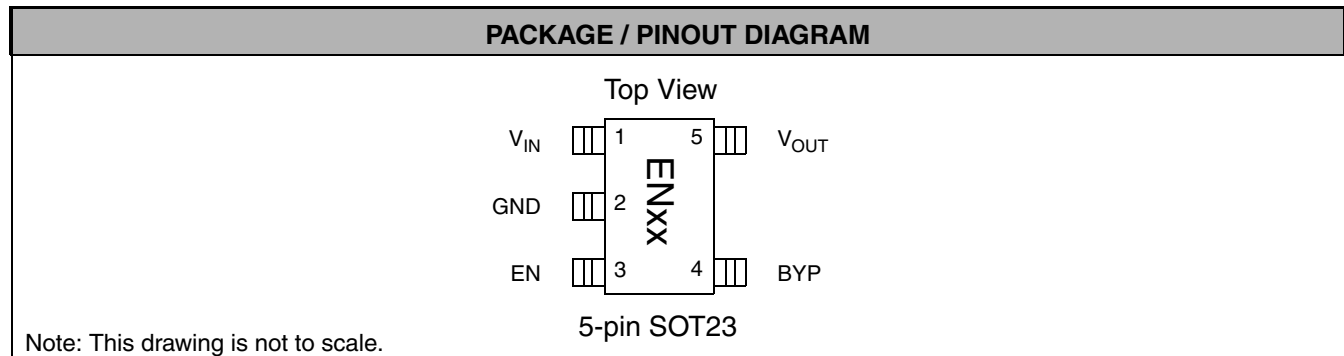

SOT-23 PART NUMBERING INFORMATION						
SOT23-5 PKG. Pins	Output Voltage	Package	Standard Finish		Lead-free Finish	
			Ordering Part Number <sup>1</sup>	Part Marking	Ordering Part Number <sup>1</sup>	Part Marking
5	1.5V	SOT23-5	CM3018-15ST	EA15	CM3018-15SO	EG15
5	1.8V	SOT23-5	CM3018-18ST	EA18	CM3018-18SO	EG18
5	2.5V	SOT23-5	CM3018-25ST	EA25	CM3018-25SO	EG25
5	2.8V	SOT23-5	CM3018-28ST	EA28	CM3018-28SO	EG28
5	2.9V	SOT23-5	CM3018-29ST	EA29	CM3018-29SO	EG29
5	3.0V	SOT23-5	CM3018-30ST	EA30	CM3018-30SO	EG30
5	3.1V	SOT23-5	CM3018-31ST	EA31	CM3018-31SO	EG31
5	3.3V	SOT23-5	CM3018-33ST	EA33	CM3018-33SO	EG33

© 2004 California Micro Devices Corp. All rights reserved.

## Package / Ordering Information (Cont'd)

### Chip Scale Package

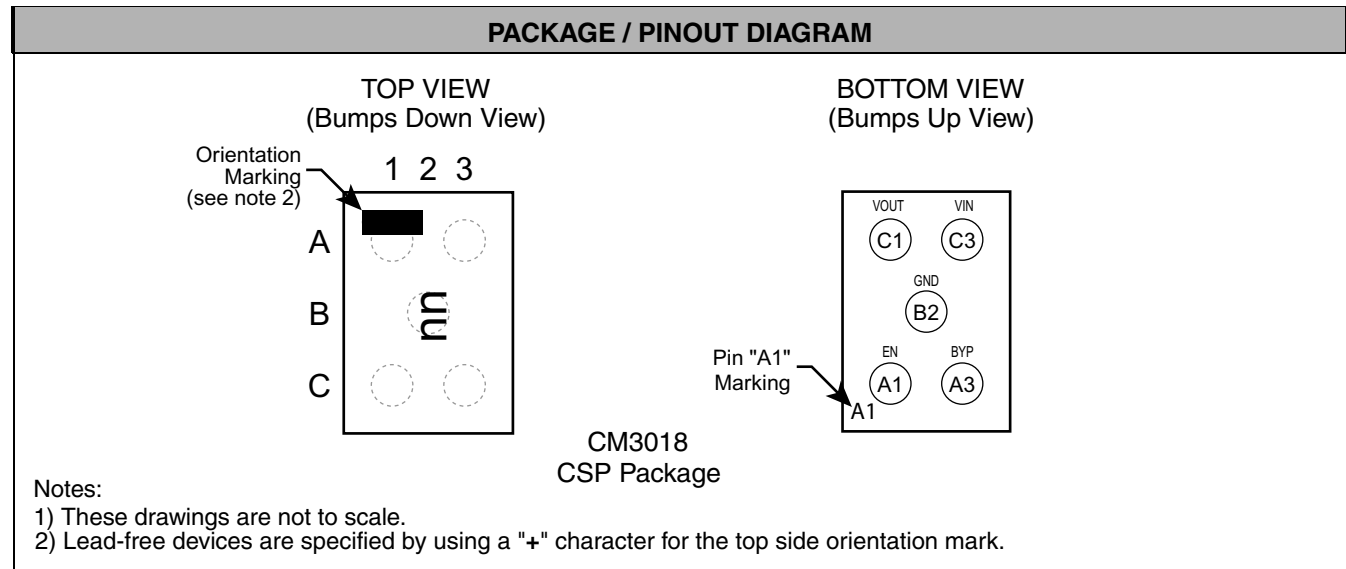

PART NUMBERING INFORMATION						
CSP BUMPS	Output Voltage	Package	Standard Finish		Lead-free Finish <sup>2</sup>	
			Ordering Part Number <sup>1</sup>	Part Marking	Ordering Part Number <sup>1</sup>	Part Marking
5	1.5V	CSP	CM3018-15CS	MA	CM3018-15CP	MA
5	1.8V	CSP	CM3018-18CS	MB	CM3018-18CP	MB
5	2.5V	CSP	CM3018-25CS	MC	CM3018-25CP	MC
5	2.6V	CSP	CM3018-26CS	MD	CM3018-26CP	MD
5	2.8V	CSP	CM3018-28CS	ME	CM3018-28CP	ME
5	2.85V	CSP	CM3018-2JCS	MF	CM3018-2JCP	MF
5	2.9V	CSP	CM3018-29CS	MG	CM3018-29CP	MG
5	3.0V	CSP	CM3018-30CS	MH	CM3018-30CP	MH
5	3.1V	CSP	CM3018-31CS	MJ	CM3018-31CP	MJ
5	3.3V	CSP	CM3018-33CS	MK	CM3018-33CP	MK

Note 1: Parts are shipped in Tape & Reel form unless otherwise specified.

Note 2: Lead-free devices are specified by using a "+" character for the top side orientation mark.

## Specifications

ABSOLUTE MAXIMUM RATINGS		
PARAMETER	RATING	UNITS
ESD Protection (HBM)	$\pm 2000$	V
Pin Voltages		
$V_{IN}$ (pin 1)	[GND - 0.6] to [+6.0]	V
EN (pin 3)	[GND - 0.6] to [ $V_{IN} + 0.6$ ]	V
$V_{OUT}$ (pin 5)	[GND - 0.6] to [ $V_{IN} + 0.6$ ]	V
Storage Temperature Range	-65 to +150	$^{\circ}\text{C}$
Operating Temperature Range		
Ambient	-40 to +85	$^{\circ}\text{C}$
Junction	0 to +130	$^{\circ}\text{C}$
Power Dissipation (Notes 1,2)	Internally Limited	W

Note 1: The CM3018 contains a thermal overload circuit that automatically disables the device thereby preventing excessive junction temperature. For example, a SOT23-5 packaged device mounted on a typical multi-layer board with a moderate heat spreading copper area (2 square inches) will allow up to 0.315W to be safely dissipated, maintaining a safe operating temperature. Please consult with factory for thermal evaluation assistance.

Note 2: Consult CAMD Technical Support to obtain detailed power dissipation information for the CM3018 packaged in the SOT23 and CSP packages.

STANDARD OPERATING CONDITIONS		
PARAMETER	RATING	UNITS
$V_{IN}$	2.7 to 5.5	V
Ambient Operating Temperature Range	-40 to +85	$^{\circ}\text{C}$
Load Current	0 to +150	mA
$C_{OUT}$	1 $\pm 20\%$	$\mu\text{F}$

**Specifications (continued)**

<b>ELECTRICAL OPERATING CHARACTERISTICS (SEE NOTE 1)</b>						
<b>SYMBOL</b>	<b>PARAMETER</b>	<b>CONDITIONS</b>	<b>MIN</b>	<b>TYP</b>	<b>MAX</b>	<b>UNITS</b>
V <sub>OUT</sub>	Regulator Output Voltage	T <sub>A</sub> = 25°C; 0mA ≤ I <sub>LOAD</sub> ≤ 150mA; V <sub>IN</sub> -V <sub>OUT</sub> = 1V	-1%		+1%	V
		0°C < T <sub>A</sub> < 125°C; 0mA ≤ I <sub>LOAD</sub> ≤ 150mA; V <sub>IN</sub> -V <sub>OUT</sub> = 1V	-2%		+2%	V
		-40°C < T <sub>A</sub> < 125°C; 0mA ≤ I <sub>LOAD</sub> ≤ 150mA; V <sub>IN</sub> -V <sub>OUT</sub> = 1V	-3%		+3%	V
V <sub>OUTRT</sub>	Regulator Response Time	No Load; C <sub>OUT</sub> = 1μF Ceramic Cap		60		μs
R <sub>DROPOUT</sub>	Dropout Resistance	0mA ≤ I <sub>LOAD</sub> ≤ 150mA		1	1.3	Ω
V <sub>R LOAD</sub>	Load Regulation	V <sub>IN</sub> -V <sub>OUT</sub> = 1V; 10mA ≤ I <sub>LOAD</sub> ≤ 150mA		.25		%
V <sub>R LINE</sub>	Line Regulation	3.3V ≤ V <sub>IN</sub> ≤ 4.3V; I <sub>LOAD</sub> = 5mA		0.15		%/V
I <sub>LIM</sub>	Overload Current Limit			400		mA
I <sub>SC</sub>	Short Circuit Current Limit	V <sub>OUT</sub> < 1V		200		mA
R <sub>DISCH</sub>	Discharge Resistance	EN tied to ground; V <sub>IN</sub> = 3.0V		300		Ω
I <sub>GND</sub>	Ground Current	with EN tied to V <sub>IN</sub> ; I <sub>LOAD</sub> = 0mA:		100	200	μA
		with EN tied to V <sub>IN</sub> ; I <sub>LOAD</sub> = 150mA:		110	250	μA
		with EN tied to GND (Disable Mode):		0.1	10	μA
V <sub>IH</sub>	Enable High Threshold	Regulator enabled		0.8	1.2	V
V <sub>IL</sub>	Enable Low Threshold	Regulator shutdown	0.4	0.7		V
I <sub>EN</sub>	Enable Input Current	V <sub>EN</sub> > 0.8V		.01		μA
T <sub>DISABLE</sub>	Shutdown Temperature			150		°C
T <sub>HYST</sub>	Thermal Hysteresis			15		°C
PSRR	Ripple Rejection	f = 120Hz; V <sub>IN</sub> - V <sub>OUT</sub> = 1V; I <sub>LOAD</sub> = 100μA; C <sub>OUT</sub> = 1μF Ceramic; C <sub>BYP</sub> = 10nF		60		dB
e <sub>N</sub>	Output Noise	300Hz-100kHz; C <sub>OUT</sub> = 10μF Ceramic; C <sub>BYP</sub> = 10nF		35		μVrms

Note 1: Electrical operating characteristics are guaranteed over standard operating conditions unless otherwise noted.

**Performance Information**

**Typical Noise Characteristics**

Curves shown for CM3018-33, 3.3V output unless noted otherwise

**Power Supply Ripple Rejection**

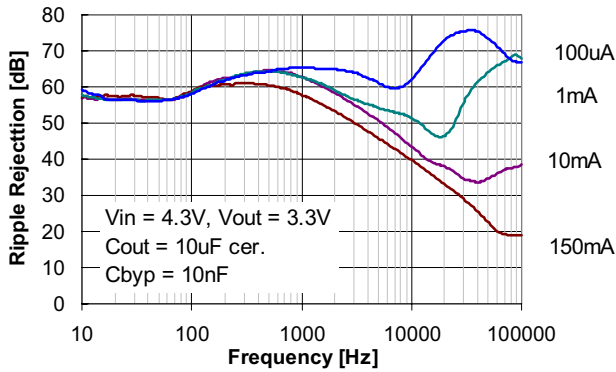

**Power Supply Ripple Rejection**

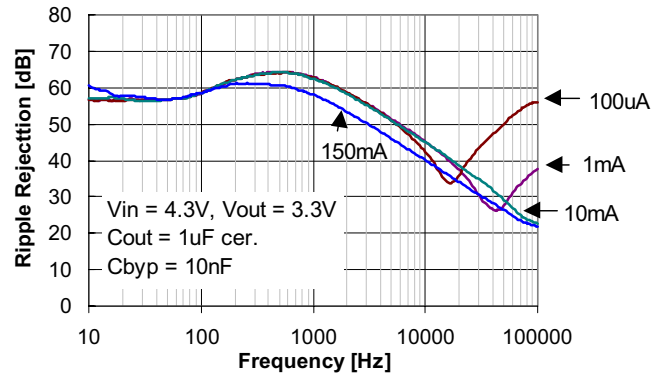

**Power Supply Ripple Rejection**

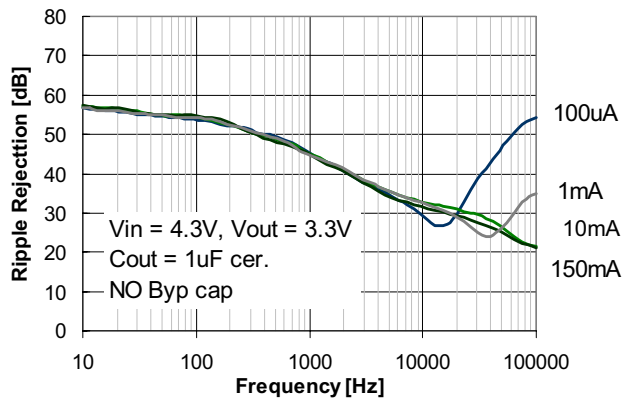

**Noise Performance**

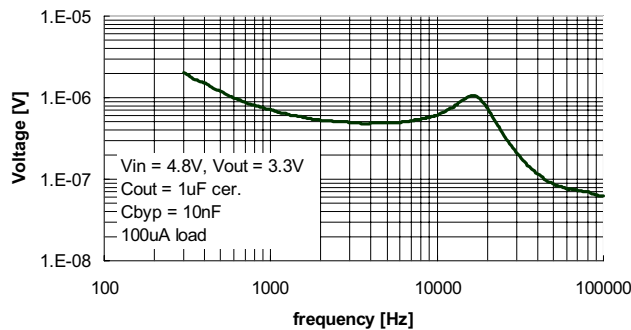

**Noise Performance**

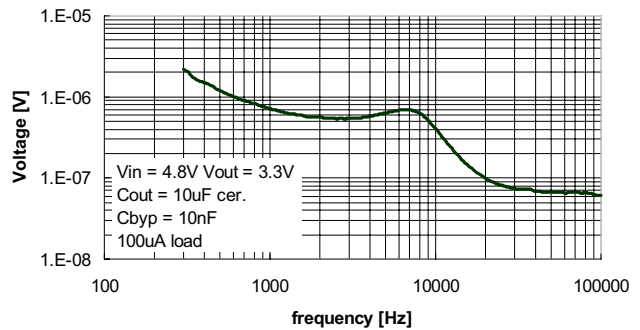

**Performance Information (cont'd)**

Typical DC Characteristics (nominal conditions unless otherwise specified)

Curves shown for CM3018-33, 3.3V output unless noted otherwise

**Ground Current vs. Input (5mA Load)**

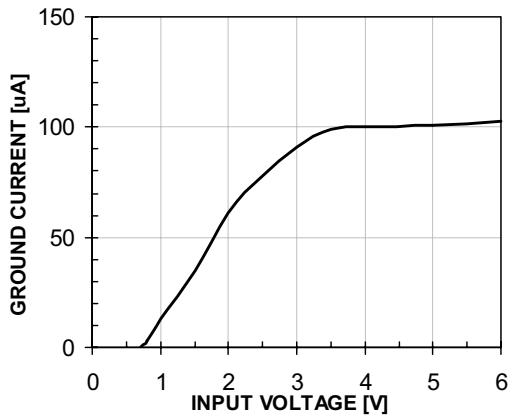

**Ground Current vs. Load (VIN = 5V)**

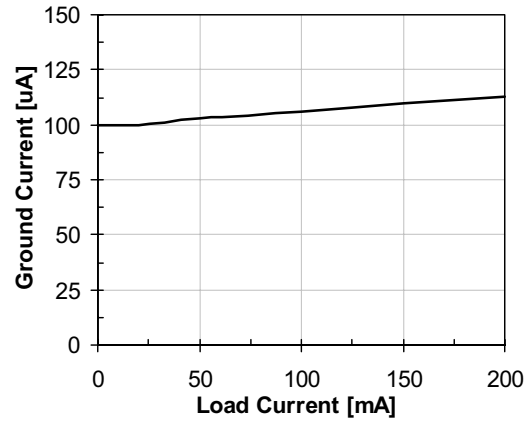

**Load Regulation (VIN = 5V)**

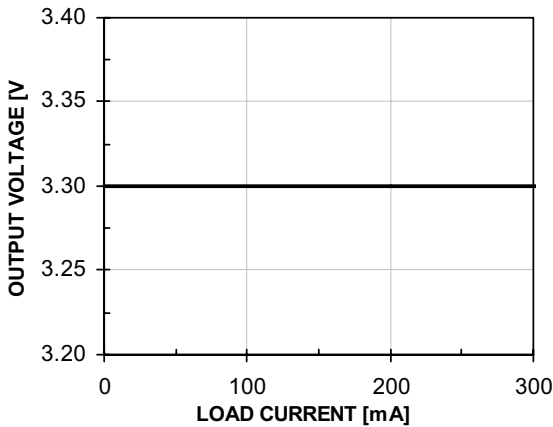

**Dropout Voltage vs. Load Current (VOOUT = 3.25V)**

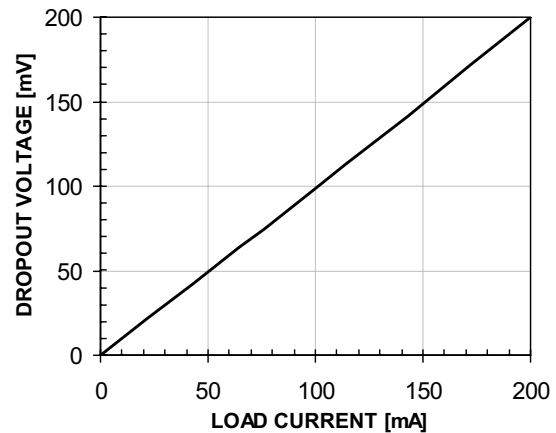

**Line Regulation (5mA Load)**

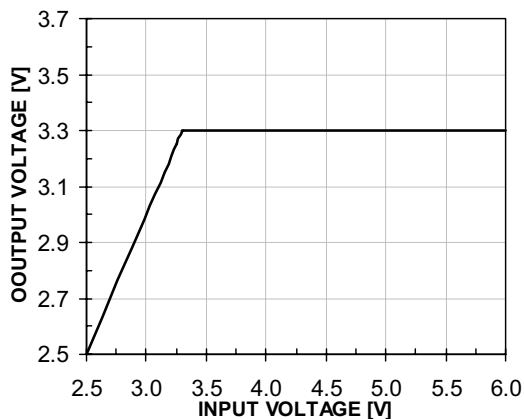

**Foldback Current Limiting (VIN = 3.8V)**

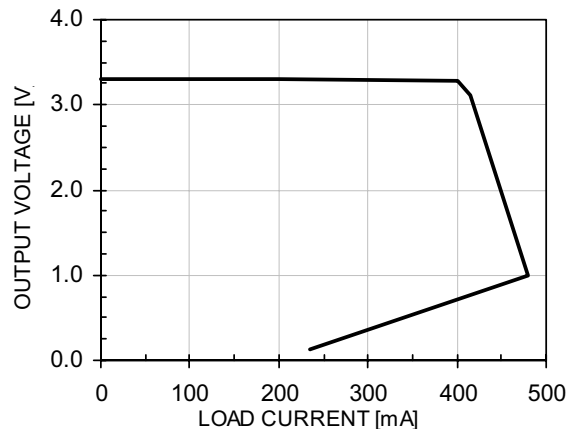

**Performance Information (cont'd)**

**Typical Transient Characteristics (nominal conditions unless specified otherwise)**

Curves shown for CM3018-33, 3.3V output unless noted otherwise

**Load transient (10% to 100%) Step Response**

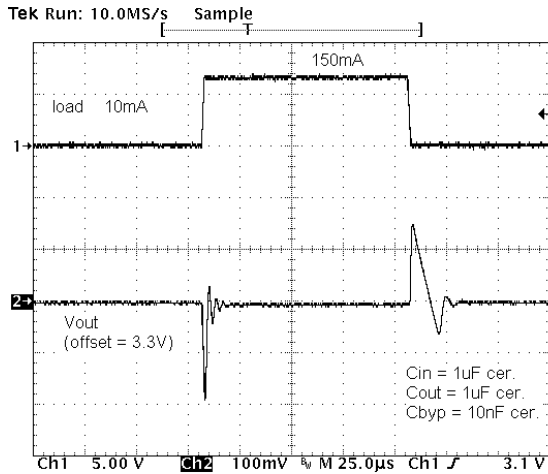

**Line Transient (1Vpp) Step Response**

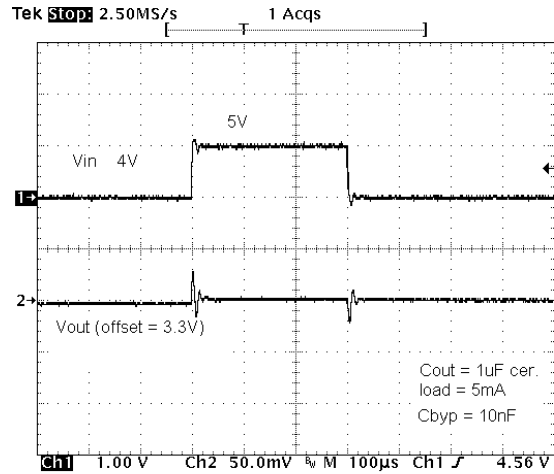

**Enable Response (CBYP = 10nF)**

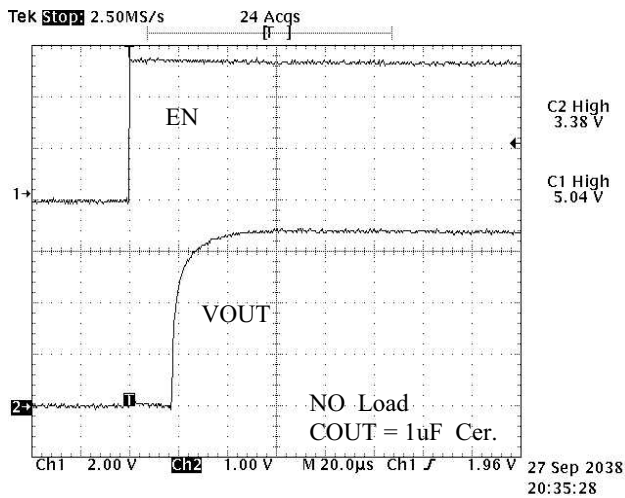

**Disable Response (CBYP = 10nF)**

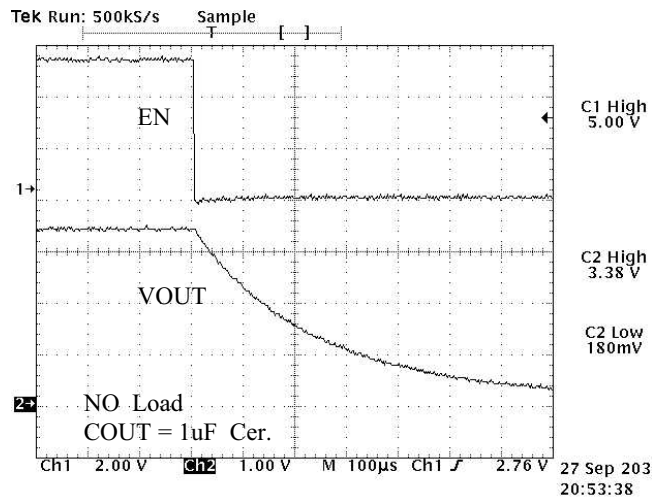



## Performance Information (cont'd)

### Typical Thermal Characteristics

The overall junction to ambient thermal resistance ( $\theta_{JA}$ ) for device power dissipation ( $P_D$ ) consists primarily of two paths in series. The first path is the junction to the case ( $\theta_{JC}$ ) which is defined by the package style, and the second path is case to ambient ( $\theta_{CA}$ ) thermal resistance which is dependent on board layout. The final operating junction temperature for any set of conditions can be estimated by the following thermal equation:

$$\begin{aligned} T_{JUNC} &= T_{AMB} + P_D * (\theta_{JC}) + P_D * (\theta_{CA}) \\ &= T_{AMB} + P_D * (\theta_{JA}) \end{aligned}$$

### SOT-23 Package Considerations

When the SOT23 version of the CM3018 is mounted on a double-sided printed circuit board with two square inches of copper allocated for "heat spreading", the resulting  $\theta_{JA}$  is 175°C/W.

Based on a maximum power dissipation of 320mW (Load x  $V_{IN}-V_{OUT} = 150mA \times 2.2V$ ) with an ambient of 70°C the resulting junction temperature will be:

$$\begin{aligned} T_{JUNC} &= T_{AMB} + P_D * (\theta_{JA}) \\ &= 70^\circ C + 315mW * (175^\circ C/W) \\ &= 70^\circ C + 57.75^\circ C = 127.75^\circ C \end{aligned}$$

Thermal characteristics were measured using a double sided board with two square inches of copper area connected to the GND pins for "heat spreading".

Measurements showing performance up to a junction temperature of 125°C were performed under light load conditions (1mA). This allows the ambient temperature to be representative of the internal junction temperature.

**Note:** The use of multi-layer board construction with separate ground and power planes will further enhance the overall thermal performance. In the event of no copper area being dedicated for heat spreading, a multi-layer board construction using only the minimum size pad layout will typically provide the CM3018 in a SOT23 package with an overall  $\theta_{JA}$  of 175°C/W, which allows up to 450mW to be dissipated safely.

Please consult CAMD Technical Support for assistance with thermal analysis of the CM3018 with respect to a specific application.

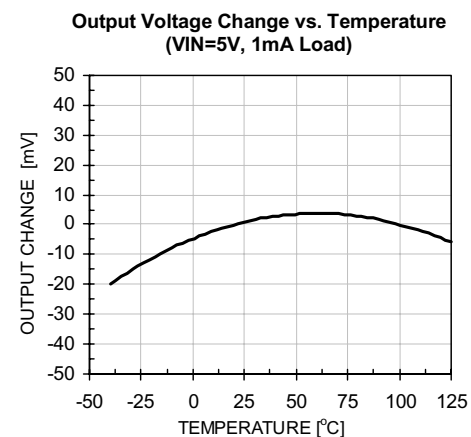
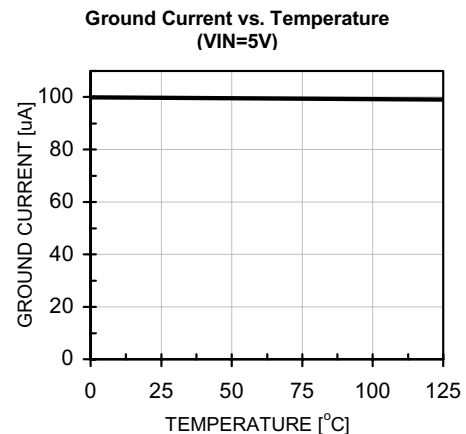

**Mechanical Details**

**SOT23 Mechanical Specifications**

Dimensions for CM3018 devices packaged in 5-pin SOT23 packages are presented below.

For complete information on the SOT23 package, see the California Micro Devices SOT23 Package Information document.

PACKAGE DIMENSIONS				
Package	SOT23 (JEDEC name is MO-178)			
Pins	5			
Dimensions	Millimeters		Inches	
	Min	Max	Min	Max
A	--	1.45	--	0.057
A1	0.00	0.15	0.000	0.006
b	0.30	0.50	0.012	0.020
c	0.08	0.22	0.003	0.009
D	2.75	3.05	0.108	0.120
E	2.60	3.00	0.102	0.118
E1	1.45	1.75	0.057	0.069
e	0.95 BSC		0.0374 BSC	
e1	1.90 BSC		0.0748 BSC	
L	0.60 REF		0.0236 REF	
# per tape and reel	3000 pieces			
Controlling dimension: inches				

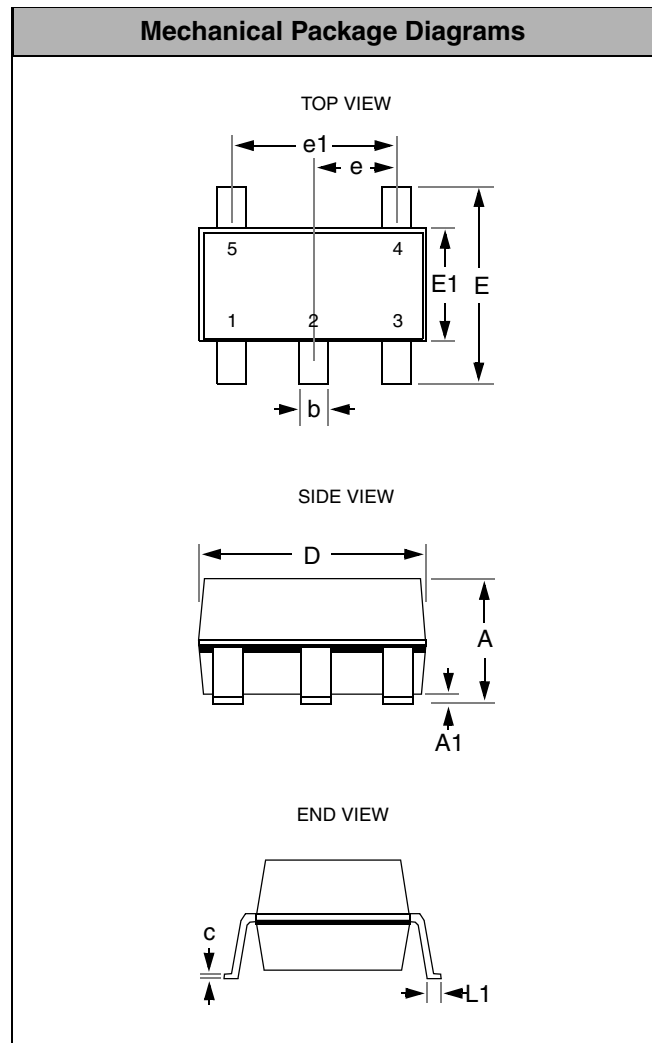

**Package Dimensions for SOT23-5.**

## Mechanical Details

### CSP Mechanical Specifications

CM3018CS/CP devices are packaged in a custom Chip Scale Package (CSP) with OptiGuard™ coating. Dimensions are presented below. For complete information on CSP packaging, see the California Micro Devices CSP Package Information document.

PACKAGE DIMENSIONS						
Package	Custom CSP					
Bumps	5					
Dim	Millimeters			Inches		
	Min	Nom	Max	Min	Nom	Max
A1	0.961	1.006	1.051	0.0378	0.0396	0.0414
A2	1.418	1.463	1.508	0.0558	0.0576	0.0594
B1	0.495	0.500	0.505	0.0195	0.0197	0.0199
B2	0.245	0.250	0.255	0.0096	0.0098	0.0100
B3	0.430	0.435	0.440	0.0169	0.0171	0.0173
B4	0.430	0.435	0.440	0.0169	0.0171	0.0173
C1	0.203	0.253	0.303	0.0080	0.0100	0.0119
C2	0.247	0.297	0.347	0.0097	0.0117	0.0136
D1	0.600	0.670	0.739	0.0236	0.0264	0.0291
D2	0.394	0.445	0.495	0.0155	0.0175	0.0195
# per tape and reel	3500 pieces					
Controlling dimension: millimeters						

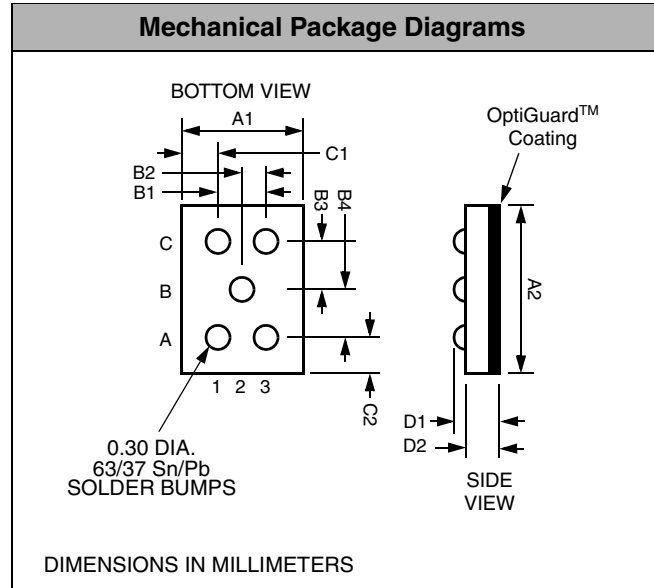

Custom 5-Bump Chip Scale Package

### CSP Tape and Reel Specifications

PART NUMBER	CHIP SIZE (mm)	POCKET SIZE (mm) B <sub>0</sub> X A <sub>0</sub> X K <sub>0</sub>	TAPE WIDTH W	REEL DIAMETER	QTY PER REEL	P <sub>0</sub>	P <sub>1</sub>
CM3018	1.463 X 1.006 X 0.670	1.67 X 1.17 X 0.730	8mm	178mm (7")	3500	4mm	4mm

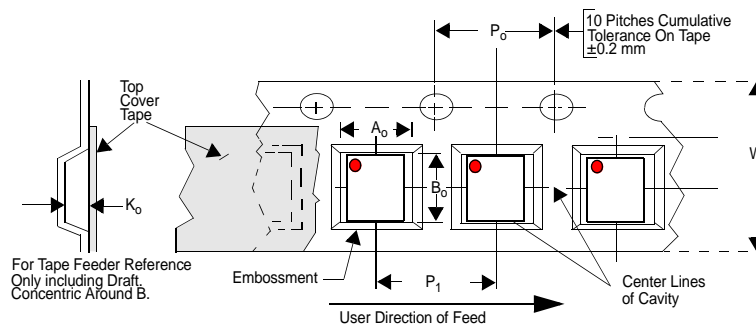

Figure 1. Tape and Reel Mechanical Data