

# MITSUBISHI IGBT MODULES CM50DY-12H

MEDIUM POWER SWITCHING USE  
INSULATED TYPE

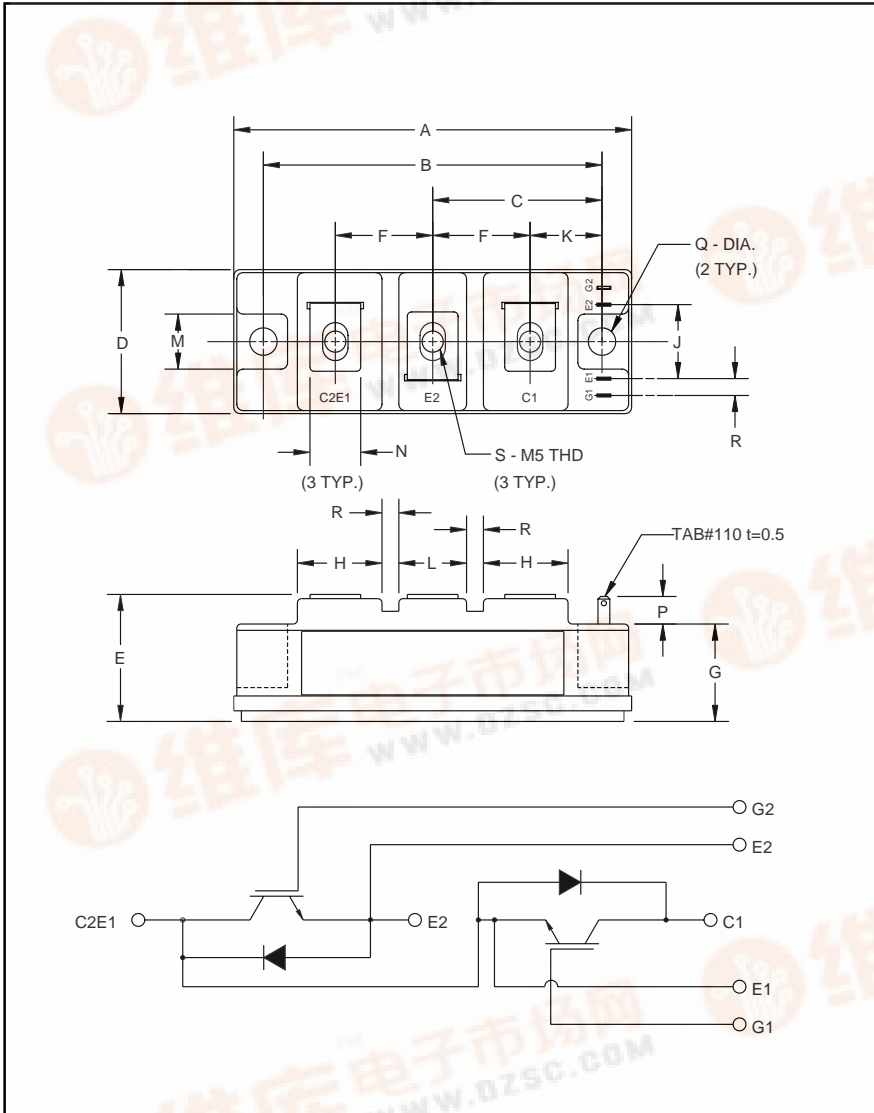

Outline Drawing and Circuit Diagram

Dimensions	Inches	Millimeters
A	3.70	94.0
B	3.150±0.01	80.0±0.25
C	1.57	40.0
D	1.34	34.0
E	1.22 Max.	31.0 Max.
F	0.90	23.0
G	0.85	21.5
H	0.79	20.0
J	0.71	18.0

Dimensions	Inches	Millimeters
K	0.67	17.0
L	0.63	16.0
M	0.51	13.0
N	0.47	12.0
P	0.28	7.0
Q	0.256 Dia.	Dia. 6.5
R	0.16	4.0
S	M5 Metric	M5



**Description:**

Mitsubishi IGBT Modules are designed for use in switching applications. Each module consists of two IGBTs in a half-bridge configuration with each transistor having a reverse-connected super-fast recovery free-wheel diode. All components and interconnects are isolated from the heat sinking baseplate, offering simplified system assembly and thermal management.

**Features:**

- Low Drive Power
- Low  $V_{CE(sat)}$
- Discrete Super-Fast Recovery Free-Wheel Diode
- High Frequency Operation
- Isolated Baseplate for Easy Heat Sinking

**Applications:**

- AC Motor Control
- Motion/Servo Control
- UPS
- Welding Power Supplies

**Ordering Information:**

Example: Select the complete part module number you desire from the table below -i.e. CM50DY-12H is a 600V ( $V_{CES}$ ), 50 Ampere Dual IGBT Module.

Type	Current Rating Amperes	$V_{CES}$ Volts (x 50)
CM	50	12



## CM50DY-12H

MEDIUM POWER SWITCHING USE  
INSULATED TYPEAbsolute Maximum Ratings,  $T_j = 25\text{ }^\circ\text{C}$  unless otherwise specified

Ratings	Symbol	CM600HU-12H	Units
Junction Temperature	$T_j$	-40 to 150	$^\circ\text{C}$
Storage Temperature	$T_{stg}$	-40 to 125	$^\circ\text{C}$
Collector-Emitter Voltage (G-E SHORT)	$V_{CES}$	600	Volts
Gate-Emitter Voltage (C-E SHORT)	$V_{GES}$	$\pm 20$	Volts
Collector Current ( $T_c = 25^\circ\text{C}$ )	$I_C$	50	Amperes
Peak Collector Current ( $T_j \leq 150^\circ\text{C}$ )	$I_{CM}$	100*	Amperes
Emitter Current** ( $T_c = 25^\circ\text{C}$ )	$I_E$	50	Amperes
Peak Emitter Current**	$I_{EM}$	100*	Amperes
Maximum Collector Dissipation ( $T_c = 25^\circ\text{C}$ )	$P_c$	250	Watts
Mounting Torque, M5 Main Terminal	–	1.47~1.96	N · m
Mounting Torque, M6 Mounting	–	1.96~2.94	N · m
Weight	–	190	Grams
Isolation Voltage (Main Terminal to Baseplate, AC 1 min.)	$V_{iso}$	2500	Vrms

\* Pulse width and repetition rate should be such that the device junction temperature ( $T_j$ ) does not exceed  $T_{j(max)}$  rating.

\*\*Represents characteristics of the anti-parallel, emitter-to-collector free-wheel diode (FWDi).

Static Electrical Characteristics,  $T_j = 25\text{ }^\circ\text{C}$  unless otherwise specified

Characteristics	Symbol	Test Conditions	Min.	Typ.	Max.	Units
Collector-Cutoff Current	$I_{CES}$	$V_{CE} = V_{CES}, V_{GE} = 0V$	–	–	1.0	mA
Gate Leakage Current	$I_{GES}$	$V_{GE} = V_{GES}, V_{CE} = 0V$	–	–	0.5	$\mu\text{A}$
Gate-Emitter Threshold Voltage	$V_{GE(th)}$	$I_C = 5\text{mA}, V_{CE} = 10V$	4.5	6.0	7.5	Volts
Collector-Emitter Saturation Voltage	$V_{CE(sat)}$	$I_C = 50\text{A}, V_{GE} = 15V$	–	2.1	2.8**	Volts
		$I_C = 50\text{A}, V_{GE} = 15V, T_j = 150^\circ\text{C}$	–	2.15	–	Volts
Total Gate Charge	$Q_G$	$V_{CC} = 300V, I_C = 50\text{A}, V_{GE} = 15V$	–	150	–	nC
Emitter-Collector Voltage	$V_{EC}$	$I_E = 50\text{A}, V_{GE} = 0V$	–	–	2.8	Volts

\*\* Pulse width and repetition rate should be such that device junction temperature rise is negligible.

Dynamic Electrical Characteristics,  $T_j = 25\text{ }^\circ\text{C}$  unless otherwise specified

Characteristics	Symbol	Test Conditions	Min.	Typ.	Max.	Units
Input Capacitance	$C_{ies}$		–	–	5.0	nF
Output Capacitance	$C_{oes}$	$V_{GE} = 0V, V_{CE} = 10V$	–	–	1.8	nF
Reverse Transfer Capacitance	$C_{res}$		–	–	1.0	nF
Resistive	Turn-on Delay Time	$t_{d(on)}$	–	–	200	ns
Load	Rise Time	$t_r$	–	–	300	ns
Switching	Turn-off Delay Time	$t_{d(off)}$	–	–	200	ns
Times	Fall Time	$t_f$	–	–	300	ns
Diode Reverse Recovery Time	$t_{rr}$	$I_E = 50\text{A}, di_E/dt = -100\text{A}/\mu\text{s}$	–	–	110	ns
Diode Reverse Recovery Charge	$Q_{rr}$	$I_E = 50\text{A}, di_E/dt = -100\text{A}/\mu\text{s}$	–	0.14	–	$\mu\text{C}$

Thermal and Mechanical Characteristics,  $T_j = 25\text{ }^\circ\text{C}$  unless otherwise specified

Characteristics	Symbol	Test Conditions	Min.	Typ.	Max.	Units
Thermal Resistance, Junction to Case	$R_{th(j-c)}$	Per IGBT	–	–	0.50	$^\circ\text{C}/\text{W}$
Thermal Resistance, Junction to Case	$R_{th(j-c)}$	Per FWDi	–	–	1.00	$^\circ\text{C}/\text{W}$
Contact Thermal Resistance	$R_{th(c-f)}$	Per Module, Thermal Grease Applied	–	–	0.075	$^\circ\text{C}/\text{W}$

# CM50DY-12H

MEDIUM POWER SWITCHING USE  
INSULATED TYPE

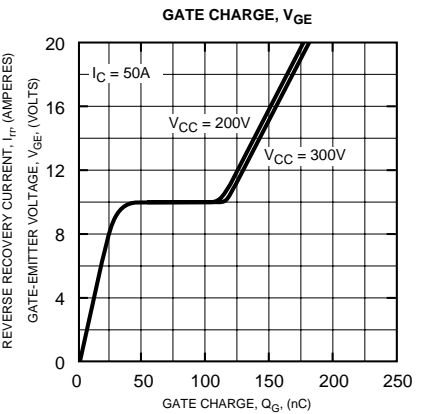
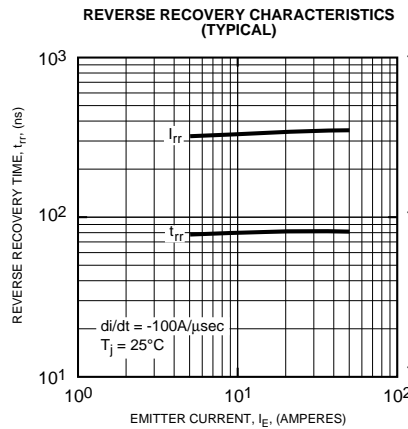
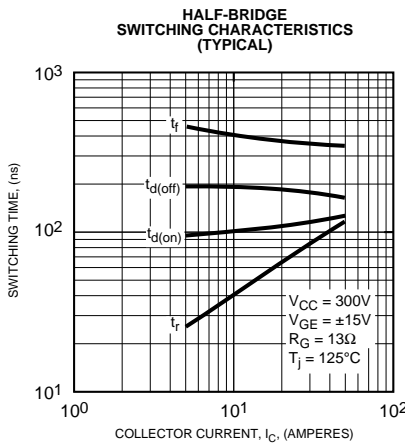
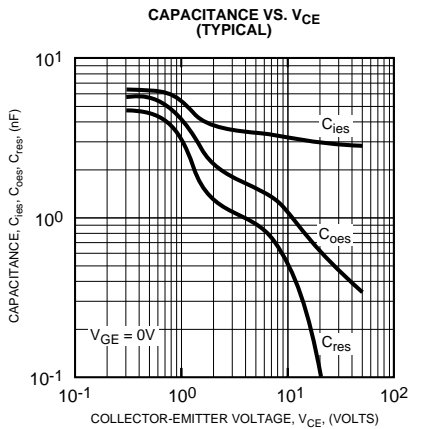
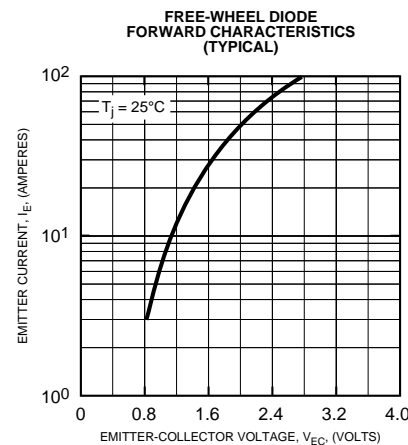
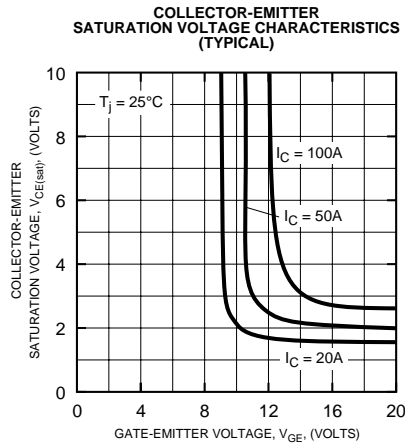
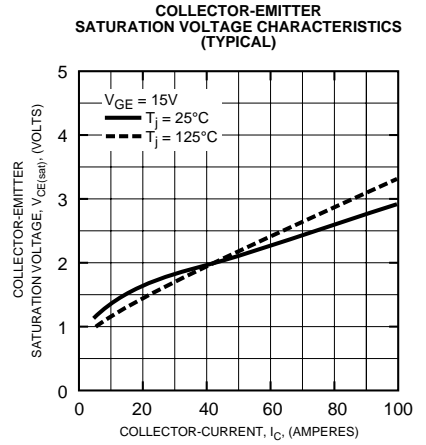
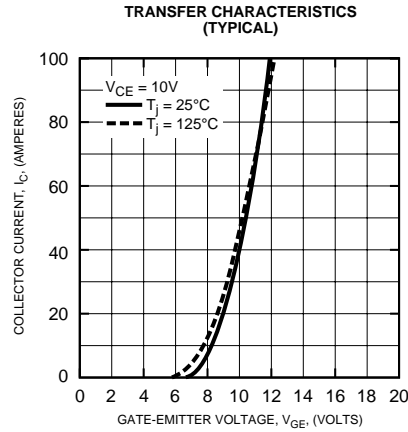
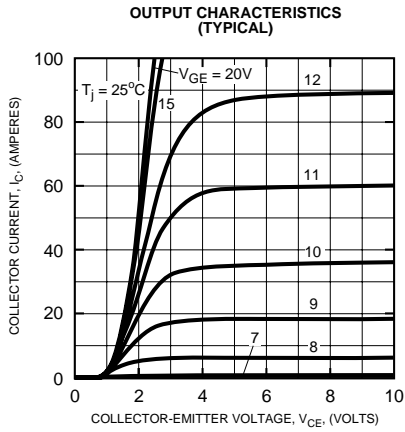

**CM50DY-12H**

MEDIUM POWER SWITCHING USE  
INSULATED TYPE

