



23 ns and 65 ns Low Voltage Comparators

CMP401/CMP402

FEATURES

- 23 ns or 65 ns Propagation Delay
- Single-Supply Operation
- Compatible with +3 V and +5 V Logic
- Separate Input and Output Sections
- Low Power
- Wide Input Range: -5 V to +3.9 V

APPLICATIONS

- Battery Operated Instrumentation
- Line Receivers
- Level Translators
- Read Channel Detection

FUNCTIONAL BLOCK DIAGRAM

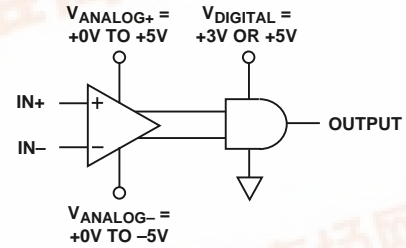

NOTE: $(V_{ANALOG+}) - (V_{ANALOG-}) \geq 3V$

GENERAL DESCRIPTION

The CMP401 and CMP402 are 23 ns and 65 ns quad comparators with separate input and output supplies. Separate supplies enable the input stage to be operated from +3 volts to as high as ±6 volts. The output can be supplied with either +3 volts or +5 volts as determined by the interface logic or available supplies. Independent input and output supplies combined with fast propagation make the CMP401 and CMP402 excellent choices for interfacing to portable instrumentation.

The CMP401 and CMP402 are specified over the extended industrial (-40°C to +125°C) temperature range. Both are available in 16-pin plastic DIP or narrow SO-16 surface mount packages. Consult factory for 16-lead TSSOP availability.

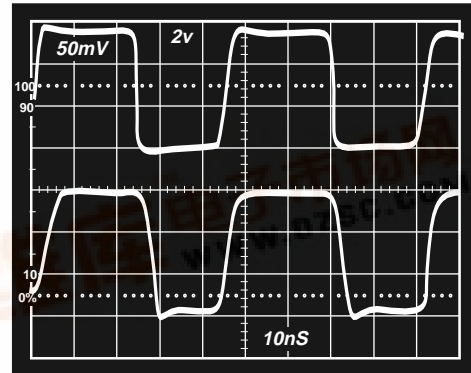

CMP401: 20 MHz Noninverting Switching. $V_{IN} = \pm 100$ mV

CMP401/CMP402–SPECIFICATIONS

ELECTRICAL SPECIFICATIONS

(@ $V_{+ANA} = V_{+DIG} = +5.0\text{ V}$, $V_{CM} = 0.1\text{ V}$, $-40^{\circ}\text{C} \leq T_A \leq +125^{\circ}\text{C}$ unless otherwise noted)

Parameter	Symbol	Conditions	Min	Typ	Max	Units
INPUT CHARACTERISTICS						
Offset Voltage ¹	V_{OS}	$T_A = +25^{\circ}\text{C}$			3	mV
Offset Voltage ¹	V_{OS}				4	mV
Hysteresis				2		mV
Input Bias Current	I_B	$T_A = +25^{\circ}\text{C}$			3	μA
	I_B				4	μA
Input Offset Current	I_{OS}				± 3	μA
Input Common-Mode Voltage Range	V_{CM}		0		+4.0	V
Common-Mode Rejection	CMRR	$0.1\text{ V} \leq V_{CM} \leq 3.9\text{ V}$	60			dB
Large Signal Voltage Gain	A_{VO}	$R_L = 10\text{ k}\Omega$		10		V/mV
Offset Voltage Drift	$\Delta V_{OS}/\Delta T$			1		$\mu\text{V}/^{\circ}\text{C}$
OUTPUT CHARACTERISTICS						
Output High Voltage	V_{OH}	$I_{OH} = -3.2\text{ mA}$	4.6			V
Output Low Voltage	V_{OL}	$I_{OL} = 3.2\text{ mA}$			0.2	V
POWER SUPPLY						
Power Supply Rejection Ratio	PSRR	V_{+ANA} and $V_{+DIG} +2.7\text{ V}$ to $+6\text{ V}$	60			dB
Analog Supply Current - CMP401	I_{ANA}	$T_A = +25^{\circ}\text{C}$			6.5	mA
Digital Supply Current - CMP401	I_{DIG}	$V_O = 0\text{ V}$, $R_L = \infty$, $T_A = +25^{\circ}\text{C}$			2.0	mA
Analog Supply Current - CMP401	I_{ANA}				8.0	mA
Digital Supply Current - CMP401	I_{DIG}	$V_O = 0\text{ V}$, $R_L = \infty$			2.25	mA
Analog Supply Current - CMP402	I_{ANA}	$T_A = +25^{\circ}\text{C}$			1.4	mA
Digital Supply Current - CMP402	I_{DIG}	$V_O = 0\text{ V}$, $R_L = \infty$, $T_A = +25^{\circ}\text{C}$			2.0	mA
Analog Supply Current - CMP402	I_{ANA}				1.75	mA
Digital Supply Current - CMP402	I_{DIG}	$V_O = 0\text{ V}$, $R_L = \infty$			2.25	mA
DYNAMIC PERFORMANCE						
Propagation Delay - CMP401	t_p	100 mV Step with 20 mV OD, $T_A = +25^{\circ}\text{C}$		17	23	ns
Propagation Delay - CMP401	t_p	100 mV Step with 5 mV OD, $T_A = +25^{\circ}\text{C}$		33		ns
Propagation Delay - CMP401	t_p	100 mV Step with 20 mV OD			30	ns
Propagation Delay - CMP402	t_p	100 mV Step with 20 mV OD, $T_A = +25^{\circ}\text{C}$		54	65	ns
Propagation Delay - CMP402	t_p	100 mV Step with 5 mV OD, $T_A = +25^{\circ}\text{C}$		60		ns
Propagation Delay - CMP402	t_p	100 mV Step with 20 mV OD			75	ns

ELECTRICAL SPECIFICATIONS

(@ $V_{+ANA} = V_{+DIG} = +3.0\text{ V}$, $V_{CM} = 0.1\text{ V}$, $T_A = +25^{\circ}\text{C}$ unless otherwise noted)

Parameter	Symbol	Conditions	Min	Typ	Max	Units
INPUT CHARACTERISTICS						
Offset Voltage ¹	V_{OS}				4.5	mV
Input Common-Mode Voltage Range	V_{CM}		0		+2.0	V
Input Differential Voltage Range	V_{DIFF}		± 2.0			V
Common-Mode Rejection	CMRR	$0.1\text{ V} \leq V_{CM} \leq 1.9\text{ V}$	60			dB
OUTPUT CHARACTERISTICS						
Output High Voltage	V_{OH}	$I_{OH} = -3.2\text{ mA}$	2.6			V
Output Low Voltage	V_{OL}	$I_{OL} = 3.2\text{ mA}$			0.25	V
POWER SUPPLY						
Power Supply Rejection Ratio	PSRR	V_{+ANA} and $V_{+DIG} +2.7\text{ V}$ to $+6\text{ V}$	60			dB
Analog Supply Current - CMP401	I_{ANA}				6	mA
Digital Supply Current - CMP401	I_{DIG}	$V_O = 0\text{ V}$, $R_L = \infty$			1	mA
Analog Supply Current - CMP402	I_{ANA}				1.2	mA
Digital Supply Current - CMP402	I_{DIG}	$V_O = 0\text{ V}$, $R_L = \infty$			1	mA
DYNAMIC PERFORMANCE						
Propagation Delay - CMP401	t_p	100 mV Step with 20 mV OD		32		ns
Propagation Delay - CMP402	t_p	100 mV Step with 20 mV OD		70		ns

CMP401/CMP402

ELECTRICAL SPECIFICATIONS (@ $V_{\pm ANA} = \pm 5\text{ V}$, $V_{DIG} = +5.0\text{ V}$, $T_A = +25^\circ\text{C}$ unless otherwise noted)

Parameter	Symbol	Conditions	Min	Typ	Max	Units
INPUT CHARACTERISTICS						
Offset Voltage ¹	V_{OS}	$V_{CM} = 0\text{ V}$			3	mV
Input Common-Mode Voltage Range	V_{CM}		-5.0		+4.0	V
Input Differential Voltage Range	V_{DIFF}		± 8.0			V
Common-Mode Rejection	CMRR	$-4.9\text{ V} \leq V_{CM} \leq 3.9\text{ V}$	60			dB
Offset Voltage Drift	$\Delta V_{OS}/\Delta T$			1	5	$\mu\text{V}/^\circ\text{C}$
POWER SUPPLY						
Power Supply Rejection Ratio	PSRR	$V_{\pm ANA} \pm 3\text{ V}$ to $\pm 6\text{ V}$	60			dB
Analog Supply Current - CMP401	I_{ANA}				6.5	mA
Digital Supply Current - CMP401	I_{DIG}	$V_O = 0\text{ V}$, $R_L = \infty$			2.0	mA
Analog Supply Current - CMP402	I_{ANA}				2.0	mA
Digital Supply Current - CMP402	I_{DIG}	$V_O = 0\text{ V}$, $R_L = \infty$			2.0	mA
DYNAMIC PERFORMANCE						
Propagation Delay - CMP401	t_p	100 mV Step with 20 mV OD			23	ns
Propagation Delay - CMP402	t_p	100 mV Step with 20 mV OD			65	ns

NOTES

¹Offset voltage is defined as $(V_{OS+} + V_{OS-})/2$.

Specifications subject to change without notice.

CMP401/CMP402

ABSOLUTE MAXIMUM RATINGS¹

Total Analog Supply Voltage	+16 V
Digital Supply Voltage	+7 V
Analog Positive Supply—Digital Positive Supply	-200 mV
Input Voltage ²	±7 V
Differential Input Voltage	±9 V
Output Short-Circuit Duration to GND	Indefinite
Storage Temperature Range	
P, S, RU Package	-65°C to +150°C
Operating Temperature Range	
CMP401G, CMP402G	-40°C to +125°C
Junction Temperature Range	
P, S, RU Package	-65°C to +150°C
Lead Temperature Range (Soldering, 60 sec)	+300°C

Package Type	θ_{JA} ³	θ_{JC}	Units
16-Pin Plastic DIP (P)	90	47	°C/W
16-Pin SO (S)	113	37	°C/W
16-Lead TSSOP (RU)	180	37	°C/W

NOTES

¹Absolute maximum ratings apply to both DICE and packaged parts, unless otherwise noted.

²The analog input voltage is equal to ±7 volts or the analog supply voltage, whichever is less.

³ θ_{JA} is specified for the worst case conditions, i.e., θ_{JA} is specified for device in socket for P-DIP, and θ_{JA} is specified for device soldered in circuit board for SOIC and TSSOP packages.

ORDERING GUIDE

Model	Temperature Range	Package Description	Package Option
CMP401GP	-40°C to +125°C	16-Pin Plastic DIP	N-16
CMP401GS	-40°C to +125°C	16-Pin SOIC	R-16A
CMP401GRU	-40°C to +125°C	16-Lead TSSOP	RU-16
CMP402GP	-40°C to +125°C	16-Pin Plastic DIP	N-16
CMP402GS	-40°C to +125°C	16-Pin SOIC	R-16A
CMP402GRU	-40°C to +125°C	16-Lead TSSOP	RU-16

DICE CHARACTERISTICS

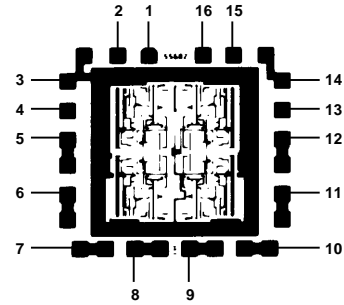

CMP401/CMP402 Die Size 0.065 × 0.069 inch, 4,485 sq. mils
Substrate (Die Backside) Is Connected to V+
Transistor Count 104.

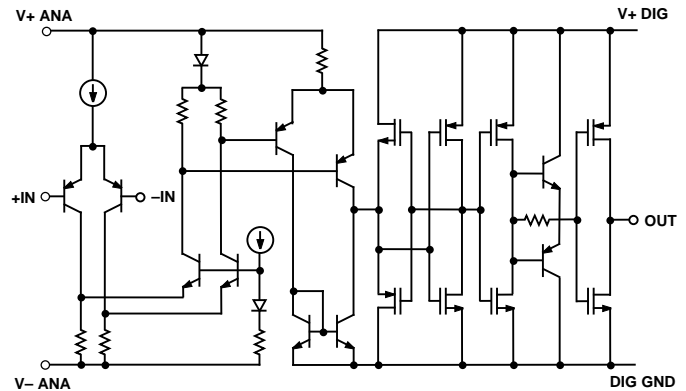
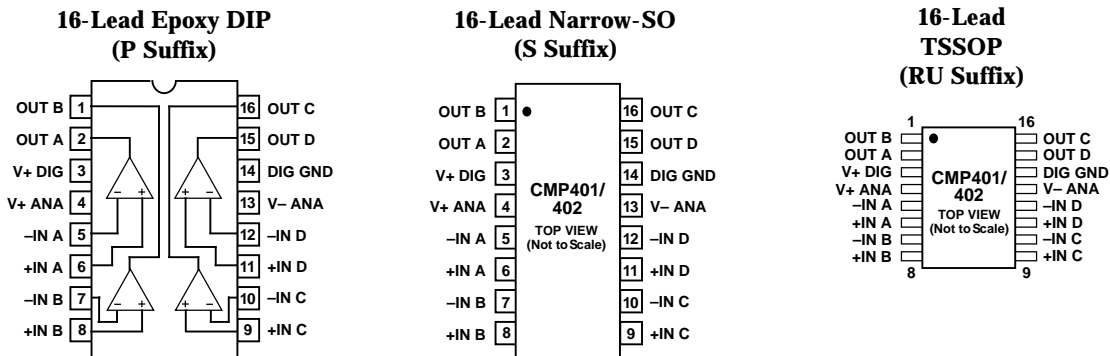

Figure 1. Simplified Schematic

CMP401/CMP402 PIN CONFIGURATIONS



CAUTION

ESD (electrostatic discharge) sensitive device. Electrostatic charges as high as 4000 V readily accumulate on the human body and test equipment and can discharge without detection. Although the CMP401/CMP402 features proprietary ESD protection circuitry, permanent damage may occur on devices subjected to high energy electrostatic discharges. Therefore, proper ESD precautions are recommended to avoid performance degradation or loss of functionality.



Typical Performance Characteristics—CMP401/CMP402

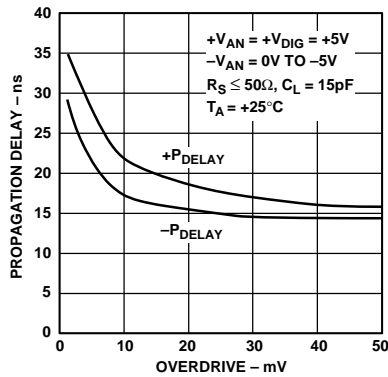

Figure 2. CMP401 Propagation Delay vs. Overdrive

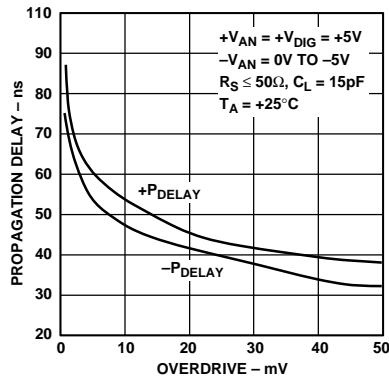

Figure 3. CMP402 Propagation Delay vs. Overdrive

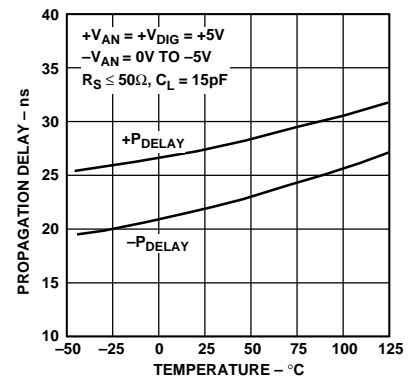

Figure 4. CMP401 Propagation Delay vs. Temperature - 5 mV OD

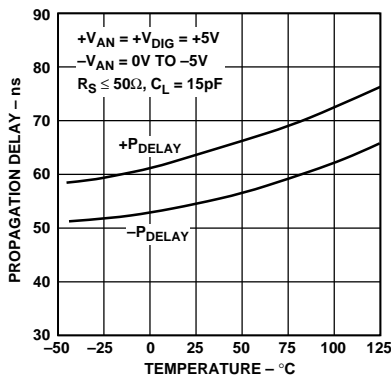

Figure 5. CMP402 Propagation Delay vs. Temperature - 5 mV OD

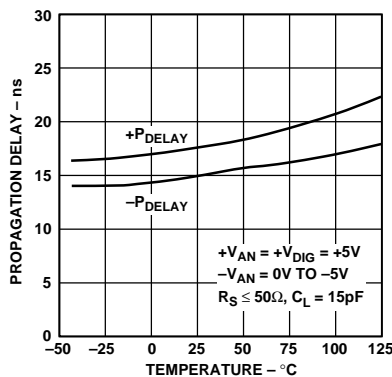

Figure 6. CMP401 Propagation Delay vs. Temperature - 20 mV OD

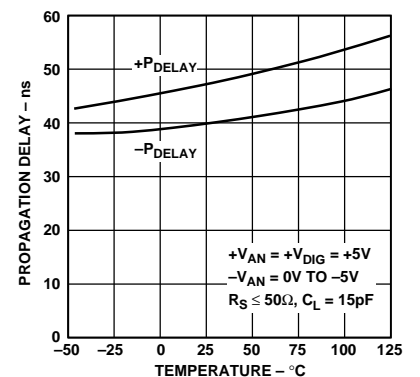

Figure 7. CMP402 Propagation Delay vs. Temperature - 20 mV OD

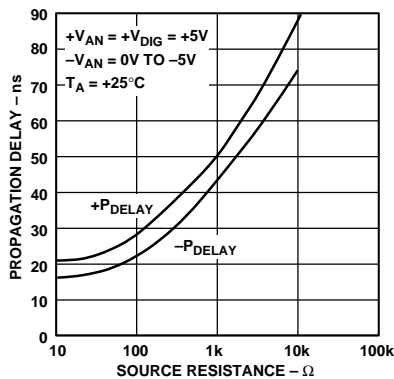

Figure 8. CMP401 Propagation Delay vs. Source Resistance - 20 mV OD

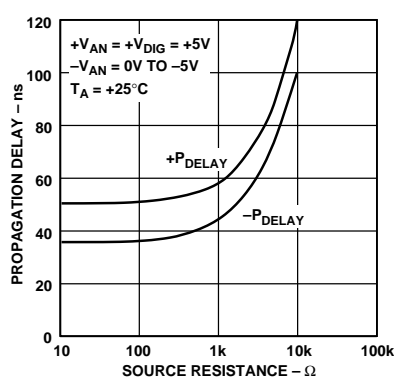

Figure 9. CMP402 Propagation Delay vs. Source Resistance - 20 mV OD

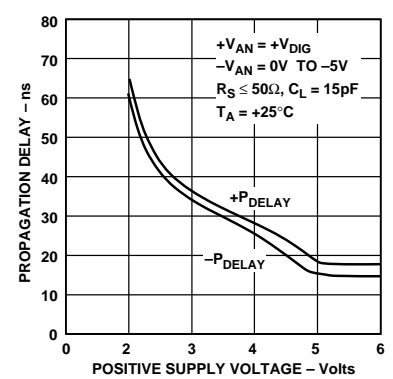

Figure 10. CMP401 Propagation Delay vs. Supply Voltage - 20 mV OD

CMP401/CMP402

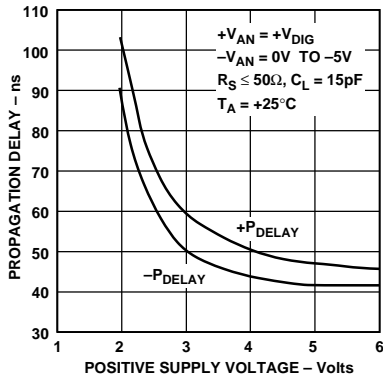

Figure 11. CMP402 Propagation Delay vs. Supply Voltage – 20 mV OD

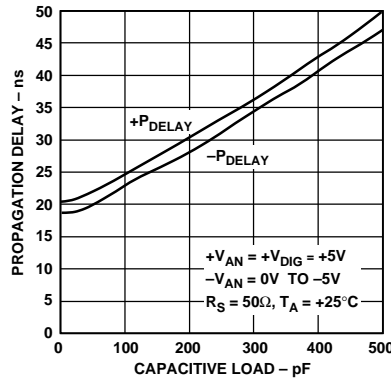

Figure 12. CMP401 Propagation Delay vs. Capacitive Load

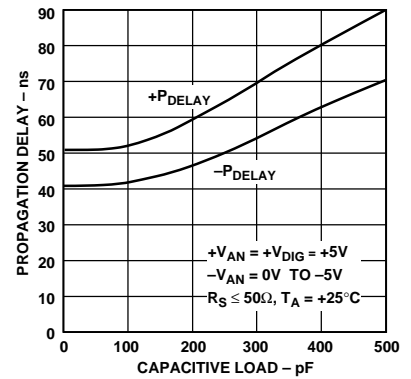

Figure 13. CMP402 Propagation Delay vs. Capacitive Load

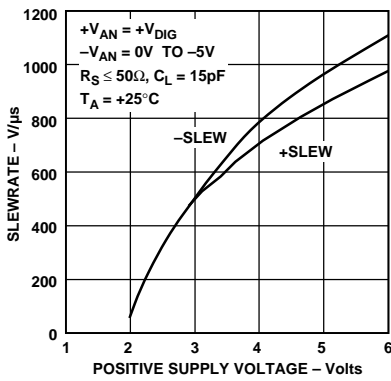

Figure 14. CMP401/CMP402 Slew Rate vs. Positive Supply Voltage

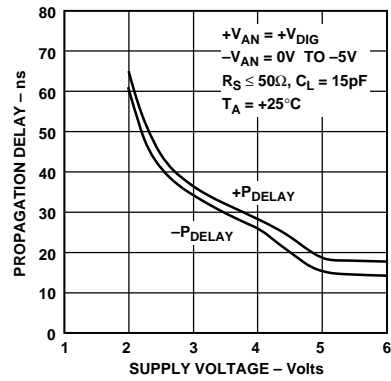

Figure 15. CMP401 Propagation Delay vs. Supply Voltage

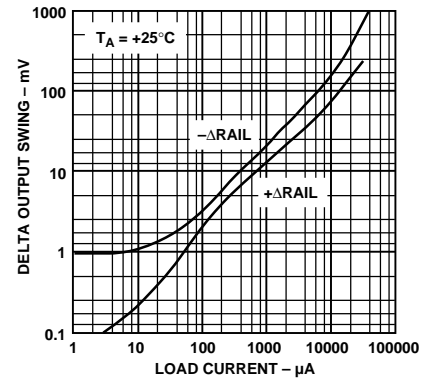

Figure 16. CMP401/CMP402 Delta Output Swing from Power Supplies vs. Load Current

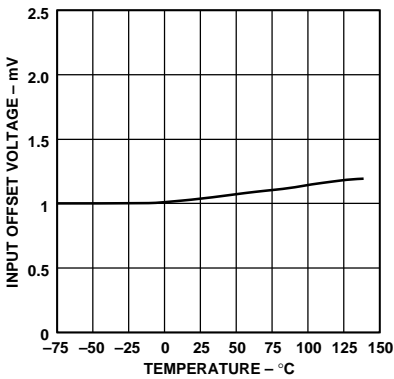

Figure 17. CMP401/CMP402 Input Offset Voltage vs. Temperature

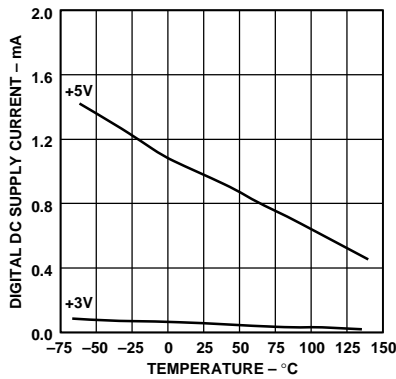

Figure 18. CMP401 Digital Supply Current vs. Temperature

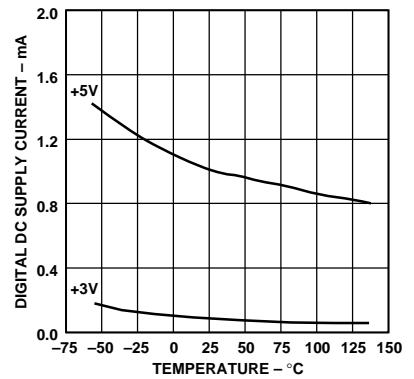

Figure 19. CMP402 Digital Supply Current vs. Temperature

CMP401/CMP402

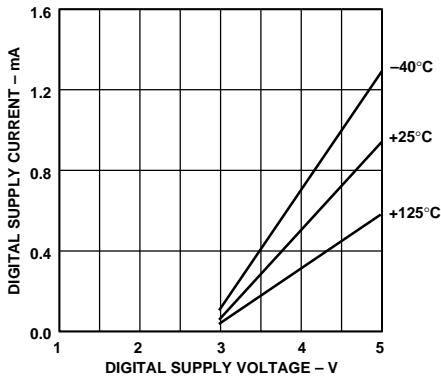

Figure 20. CMP401 Digital Supply Current vs. Digital Supply Voltage

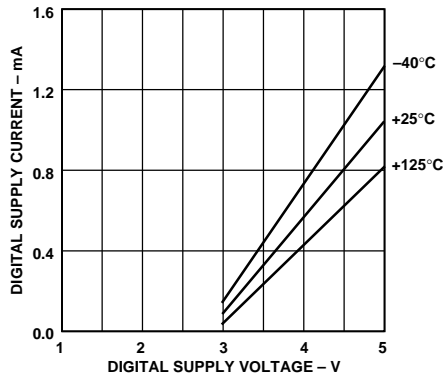

Figure 21. CMP402 Digital Supply Current vs. Digital Supply Voltage

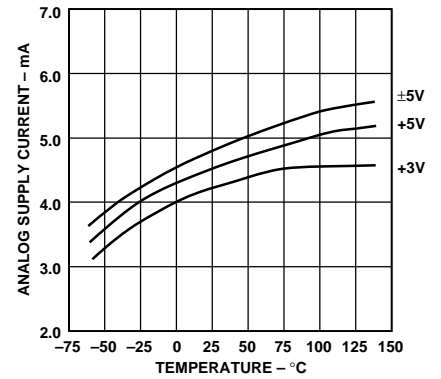

Figure 22. CMP401 Analog Supply Current vs. Temperature

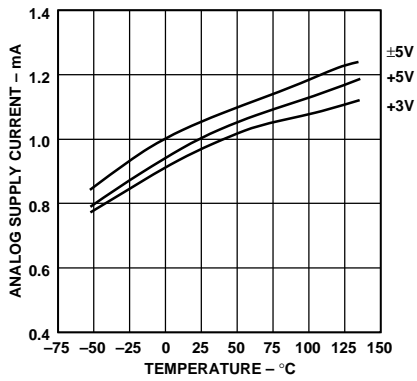

Figure 23. CMP402 Analog Supply Current vs. Temperature

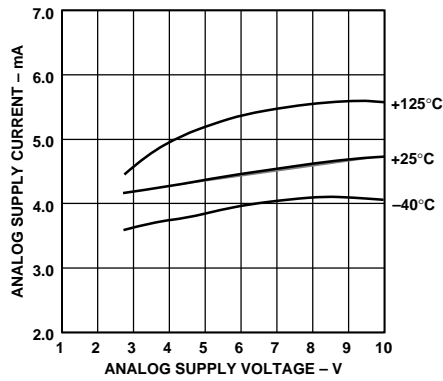

Figure 24. CMP401 Analog Supply Current vs. Analog Supply Voltage

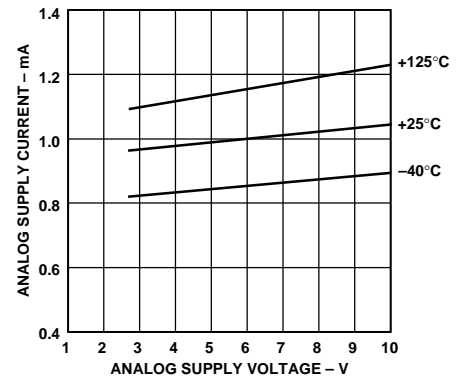

Figure 25. CMP402 Analog Supply Current vs. Analog Supply Voltage

CMP401/CMP402

OUTLINE DIMENSIONS

Dimensions shown in inches and (mm).

16-Pin Epoxy DIP (N-16)

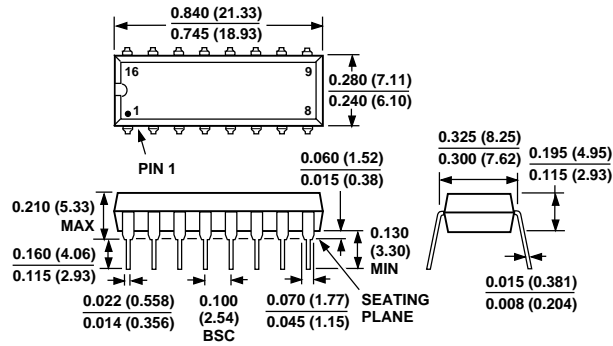

16-Pin Narrow-SOIC (R-16A)

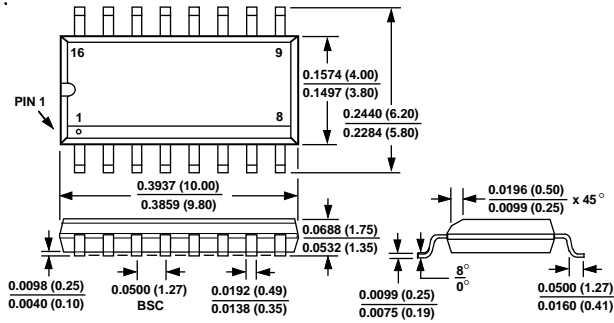

16-Lead TSSOP (RU-16)

