

CND0004A

Optical Transceiver Module for IrDA

Overview

CND0004A is a high speed response, high reliability infrared data link device. It consists of a high speed GaAlAs infrared light emitting diode, a high speed PIN photodiode and a post processing IC, and they are housed in a single package.

Features

- Small size package
- Compatible with reflow soldering process
- Low voltage driving capability, operating source voltage (2.7 to 5.5 V)
- IrDA Ver 1.0 compatible (max. 115.2 kbps)
- Includes shutdown function

Absolute Maximum Ratings (Ta = 25°C)

	Parameter	Symbol	Ratings	Unit
Transmitter TX	LED peak forward current	I_{FP}^*	400	mA
	Data input voltage	V_I	-0.5 to $V_{CC}+0.5$	V
Receiver RX	Supply voltage	V_{CC}	-0.5 to +7	V
	Output sinking current	I_{OL}	10	mA
	Data output voltage	V_O	-0.5 to $V_{CC}+0.5$	V
Temperature	Operating ambient temperature	T_{opr}	0 to +70	°C
	Storage temperature	T_{stg}	-20 to +85	°C

* Duty ratio ≤ 20 %, pulse width ≤ 90 μs

Electro-Optical Characteristics (Ta = 25°C)

	Parameter	Symbol	Conditions	min	typ	max	Unit
	Operating supply voltage	V_{CC}		2.7	5	5.5	V
	Supply current (Receiver)	I_{CC}	$V_{CC} = 5V, V_I = 0.5V, V_{SD} \leq 0.5V$ (light shut off)			1.2	mA
	Data rates			2.4		115.2	kbps
TX	High level input voltage	V_{IH}	$V_{CC} = 2.7$ to $5.5V, V_{SD} \leq 0.5V$	2.5		V_{CC}	V
	Low level input voltage	V_{IL}	$V_{CC} = 2.7$ to $5.5V, V_{SD} \leq 0.5V$	0		0.5	V
	Rise time, fall time	t_r, t_f	$V_{CC} = 5V, R_{LED} = 12\Omega$			0.6	μs
RX	Maximum transfer distance	L_{max}	Transmitter side 40mW/sr	1			m
	High level output voltage	V_{OH}	$I_{OH} \leq 20\mu A$ (light shut off)	$V_{CC}-0.5$			V
	Low level output voltage	V_{OL}	$I_{OL} \leq 4mA$ (light receiving)			0.5	V

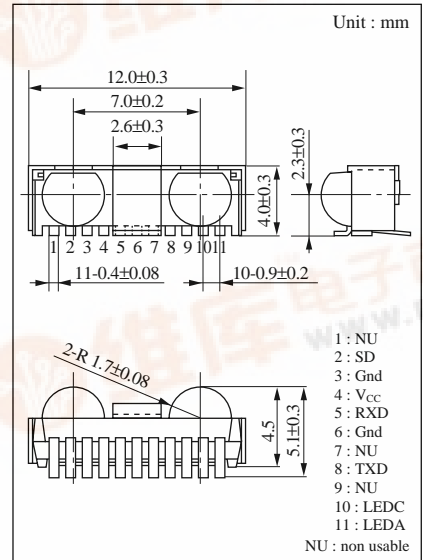

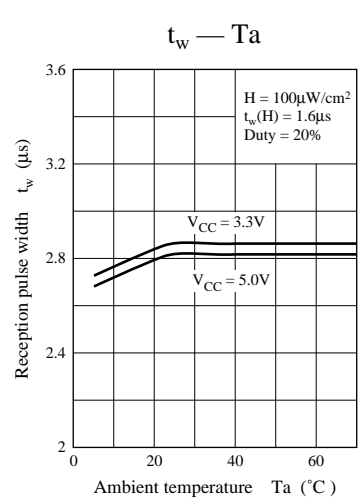
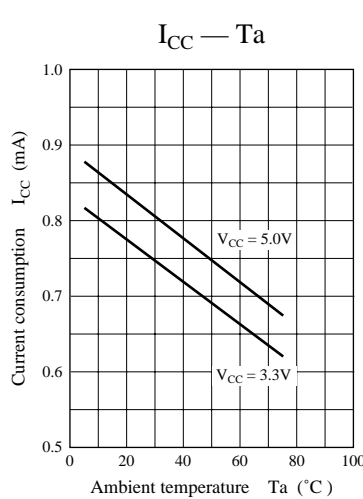
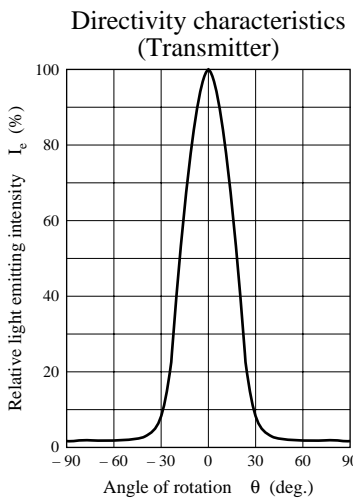
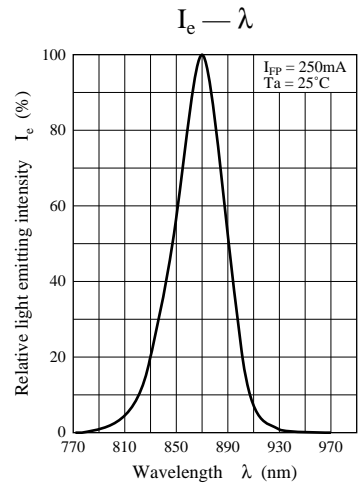
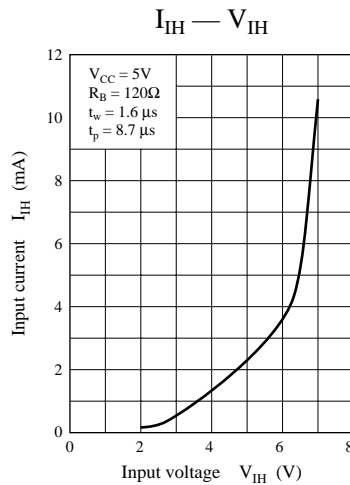
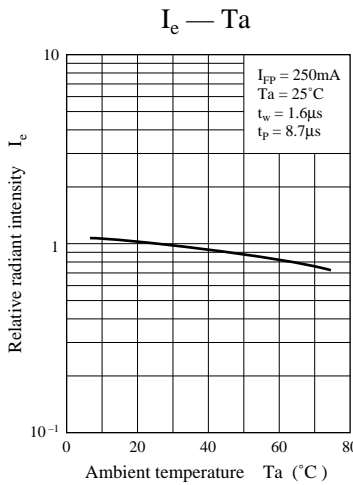
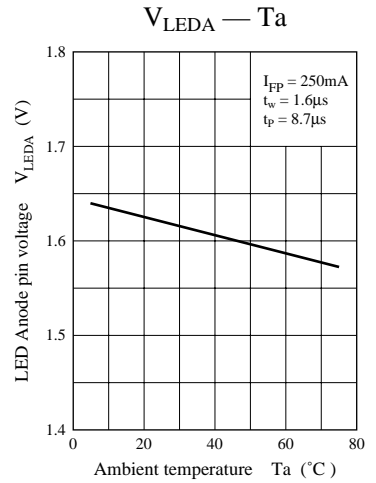
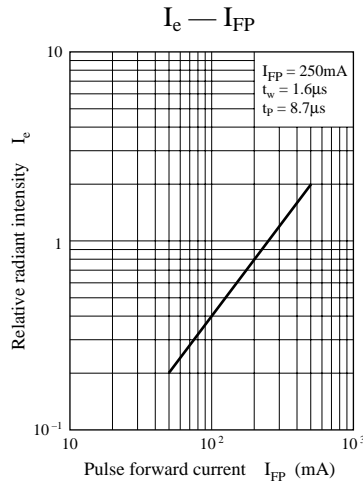
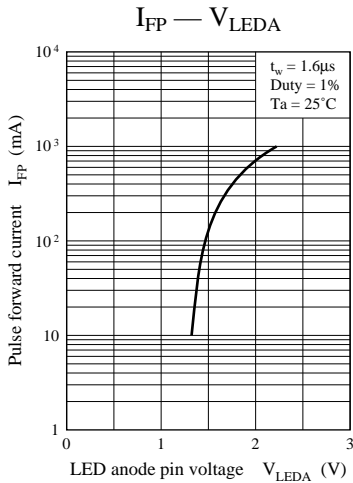

Directivity characteristics
(Receiver)

