



CNY117

Vishay Semiconductors

Optocoupler, Phototransistor Output, With Base Connection, 110 °C Rated

Features

- Operating temperature from - 55 °C to + 110 °C
- Breakdown Voltage, 5300 V_{RMS}
- Long Term Stability
- Industry Standard Dual-in-Line Package
- Lead-free component
- Component in accordance to RoHS 2002/95/EC and WEEE 2002/96/EC

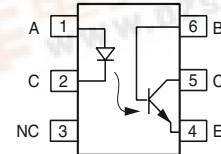
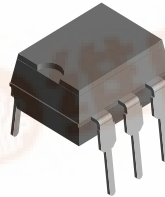

1179004



Agency Approvals

- UL1577, File No. E52744 System Code H or J, Double Protection
- DIN EN 60747-5-2 (VDE0884)
- CUL - File No. E52744, equivalent to CSA bulletin 5A

The coupling device is suitable for signal transmission between two electrically separated circuits. The potential difference between the circuits to be coupled is not allowed to exceed the maximum permissible reference voltages.

Applications

AC adapter
SMPS
PLC
Factory Automation
Game Consoles

Order Information

Part	Remarks
CNY117-1	CTR 40 - 80 %, DIP-6
CNY117-2	CTR 63 - 125 %, DIP-6
CNY117-3	CTR 100 - 200 %, DIP-6
CNY117-4	CTR 160 - 320 %, DIP-6

For additional information on the available options refer to Option Information.

Description

The CNY117 is a 110 °C rated optocoupler consisting of a Gallium Arsenide infrared emitting diode optically coupled to a silicon planar phototransistor detector in a plastic plug-in DIP-6 package.



Absolute Maximum Ratings

$T_{amb} = 25\text{ }^{\circ}\text{C}$, unless otherwise specified

Stresses in excess of the absolute Maximum Ratings can cause permanent damage to the device. Functional operation of the device is not implied at these or any other conditions in excess of those given in the operational sections of this document. Exposure to absolute Maximum Rating for extended periods of the time can adversely affect reliability.

Input

Parameter	Test condition	Symbol	Value	Unit
Reverse voltage		V_R	6.0	V
DC Forward current		I_F	60	mA
Surge forward current	$t \leq 10\text{ }\mu\text{s}$	I_{FSM}	2.5	A
Power dissipation		P_{diss}	100	mW
Derate linearly from 25 °C			1.0	mW/°C

Output

Parameter	Test condition	Symbol	Value	Unit
Collector-emitter breakdown voltage		BV_{CEO}	70	V
Collector current		I_C	50	mA
	$t \leq 1.0\text{ ms}$	I_C	100	mA
Total power dissipation		P_{diss}	150	mW
Derate linearly from 25 °C			1.5	mW/°C

Coupler

Parameter	Test condition	Symbol	Value	Unit
Isolation test voltage (between emitter and detector referred to standard climate 23/50 DIN 50014)		V_{ISO}	5300	V_{RMS}
Creepage			≥ 7.0	mm
Clearance			≥ 7.0	mm
Isolation thickness between emitter and detector			≥ 0.4	mm
Comparative tracking index per DIN IEC 112/VDE 0303, part 1			175	
Isolation resistance	$V_{IO} = 500\text{ V}$	R_{IO}	$\geq 10^{11}$	Ω
Storage temperature range		T_{stg}	- 55 to + 150	°C
Ambient temperature range		T_{amb}	- 55 to + 110	°C
Soldering temperature	max. 10 s, dip soldering: distance to seating plane $\geq 1.5\text{ mm}$	T_{sld}	260	°C



Electrical Characteristics

$T_{amb} = 25\text{ }^{\circ}\text{C}$, unless otherwise specified

Minimum and maximum values are testing requirements. Typical values are characteristics of the device and are the result of engineering evaluation. Typical values are for information only and are not part of the testing requirements.

Input

Parameter	Test condition	Symbol	Min	Typ.	Max	Unit
Forward voltage	$I_F = 60\text{ mA}$	V_F		1.25	1.65	V
Breakdown voltage	$I_R = 10\text{ }\mu\text{A}$	V_{BR}	6.0			V
Reserve current	$V_R = 6.0\text{ V}$	I_R		0.01	10	μA
Capacitance	$V_R = 0\text{ V}$, $f = 1.0\text{ MHz}$	C_O		25		pF

Output

Parameter	Test condition	Symbol	Min	Typ.	Max	Unit
Collector-emitter capacitance	$V_{CE} = 5.0\text{ V}$, $f = 1.0\text{ MHz}$	C_{CE}		5.2		pF
Base - collector capacitance	$V_{CE} = 5.0\text{ V}$, $f = 1.0\text{ MHz}$	C_{BC}		6.5		pF
Emitter - base capacitance	$V_{CE} = 5.0\text{ V}$, $f = 1.0\text{ MHz}$	C_{EB}		7.5		pF

Coupler

Parameter	Test condition	Part	Symbol	Min	Typ.	Max	Unit
Saturation voltage, collector-emitter	$I_F = 10\text{ mA}$, $I_C = 2.5\text{ mA}$		V_{CEsat}		0.25	0.4	V
Coupling capacitance			C_C		0.6		pF
Collector-emitter leakage current	$V_{CE} = 10\text{ V}$	CNY117-1	I_{CEO}		2.0	50	nA
		CNY117-2	I_{CEO}		2.0	50	nA
		CNY117-3	I_{CEO}		5.0	100	nA
		CNY117-4	I_{CEO}		5.0	100	nA

Current Transfer Ratio

Current Transfer Ratio I_C/I_F at $V_{CE} = 5.0\text{ V}$, $25\text{ }^{\circ}\text{C}$ and Collector-Emitter Leakage Current by dash number

Parameter	Test condition	Part	Symbol	Min	Typ.	Max	Unit
Current Transfer Ratio	$I_F = 10\text{ mA}$	CNY117-1	CTR	40		80	%
		CNY117-2	CTR	63		125	%
		CNY117-3	CTR	100		200	%
		CNY117-4	CTR	160		320	%
	$I_F = 1.0\text{ mA}$	CNY117-1	CTR	13	30		%
		CNY117-2	CTR	22	45		%
		CNY117-3	CTR	34	70		%
		CNY117-4	CTR	56	90		%

Switching Characteristics

Linear operation (without saturation)

Parameter	Test condition	Symbol	Min	Typ.	Max	Unit
Turn-on time	$I_F = 10 \text{ mA}$, $V_{CC} = 5.0 \text{ V}$, $R_L = 75 \text{ W}$	t_{on}		3.0		μs
Rise time	$I_F = 10 \text{ mA}$, $V_{CC} = 5.0 \text{ V}$, $R_L = 75 \text{ W}$	t_r		2.0		μs
Turn-off time	$I_F = 10 \text{ mA}$, $V_{CC} = 5.0 \text{ V}$, $R_L = 75 \text{ W}$	t_{off}		2.3		μs
Fall time	$I_F = 10 \text{ mA}$, $V_{CC} = 5.0 \text{ V}$, $R_L = 75 \text{ W}$	t_f		2.0		μs
Cut-off frequency	$I_F = 10 \text{ mA}$, $V_{CC} = 5.0 \text{ V}$, $R_L = 75 \text{ W}$	f_{CO}		250		kHz

Switching operation (with saturation)

Parameter	Test condition	Part	Symbol	Min	Typ.	Max	Unit
Turn-on time	$I_F = 20 \text{ mA}$	CNY117-1	t_{on}		3.0		μs
	$I_F = 10 \text{ mA}$	CNY117-2	t_{on}		4.2		μs
		CNY117-3	t_{on}		4.2		μs
	$I_F = 5.0 \text{ mA}$	CNY117-4	t_{on}		6.0		μs
Rise time	$I_F = 20 \text{ mA}$	CNY117-1	t_r		2.0		μs
	$I_F = 10 \text{ mA}$	CNY117-2	t_r		3.0		μs
		CNY117-3	t_r		3.0		μs
	$I_F = 5.0 \text{ mA}$	CNY117-4	t_r		4.6		μs
Turn-off time	$I_F = 20 \text{ mA}$	CNY117-1	t_{off}		18		μs
	$I_F = 10 \text{ mA}$	CNY117-2	t_{off}		23		μs
		CNY117-3	t_{off}		23		μs
	$I_F = 5.0 \text{ mA}$	CNY117-4	t_{off}		25		μs
Fall time	$I_F = 20 \text{ mA}$	CNY117-1	t_f		11		μs
	$I_F = 10 \text{ mA}$	CNY117-2	t_f		14		μs
		CNY117-3	t_f		14		μs
	$I_F = 5.0 \text{ mA}$	CNY117-4	t_f		15		μs

Typical Characteristics ($T_{amb} = 25 \text{ }^\circ\text{C}$ unless otherwise specified)

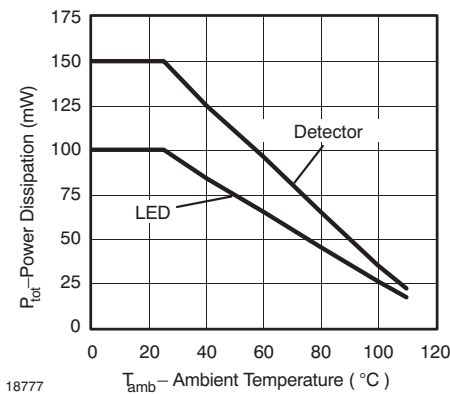

Figure 1. Permissible Power Dissipation vs. Ambient Temperature

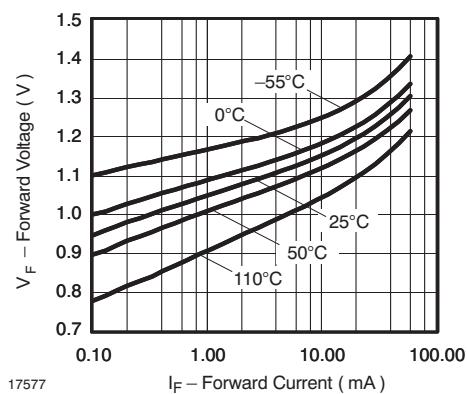

Figure 2. Forward Voltage vs. Forward Current

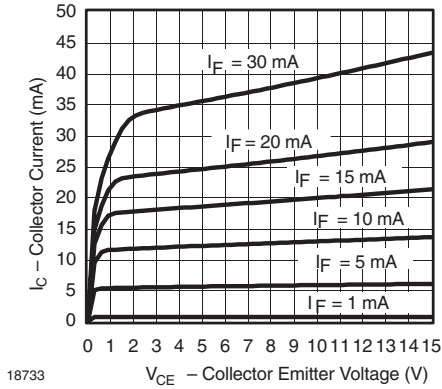

Figure 3. Collector Current vs. Collector Emitter Voltage

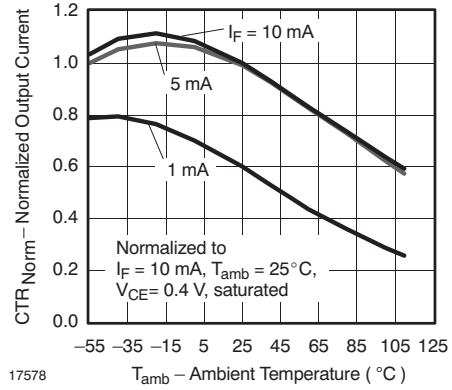

Figure 6. Normalized Current Transfer Ratio vs. Ambient Temperature

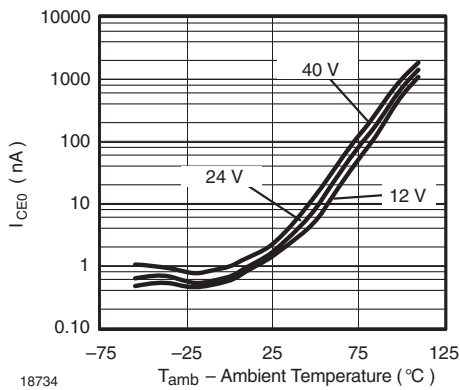

Figure 4. Collector to Emitter Dark Current vs. Ambient Temperature

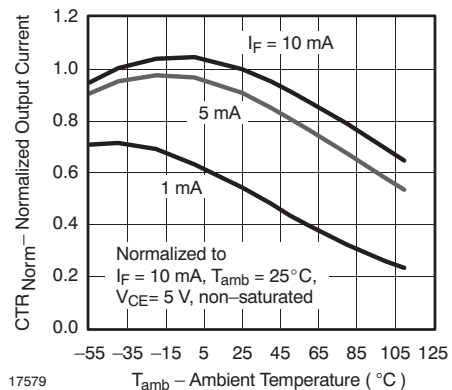

Figure 7. Normalized Current Transfer Ratio vs. Ambient Temperature

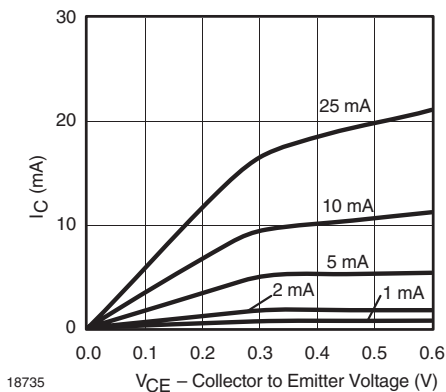

Figure 5. Normalized Current vs. Collector Emitter Saturation Voltage

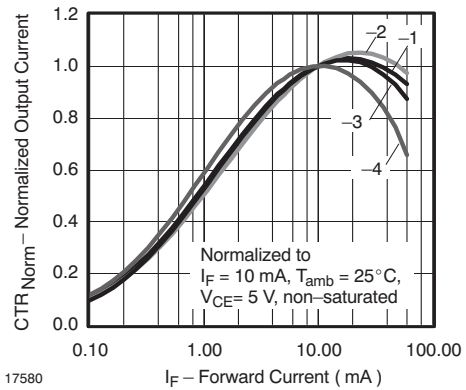
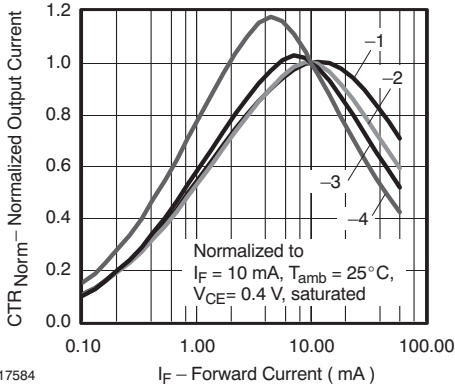
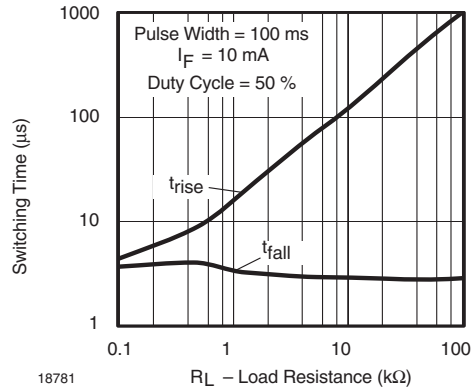

Figure 8. Normalized CTR vs. Forward Current



17584

Figure 9. Normalized CTR vs. Forward Current



18781

Figure 12. Time Switching vs. Load Resistance

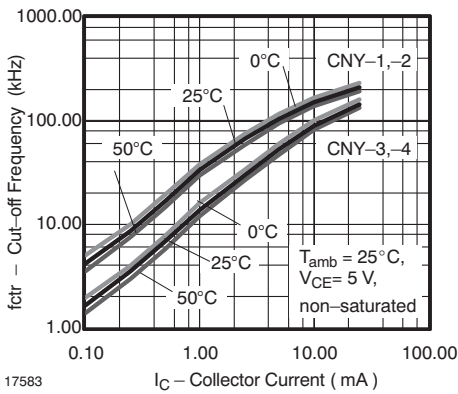

17583

Figure 10. Cut-off Frequency vs. Collector Current

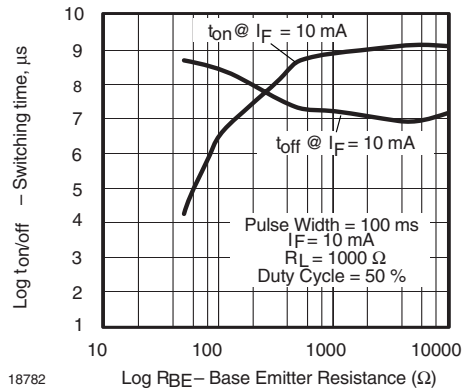

18782

Figure 13. Switching Time vs. Base Emitter Resistance

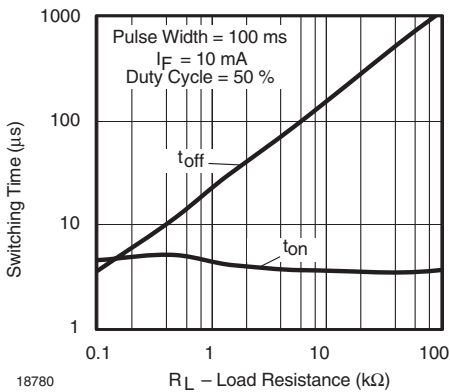

18780

Figure 11. Time Switching vs. Load Resistance

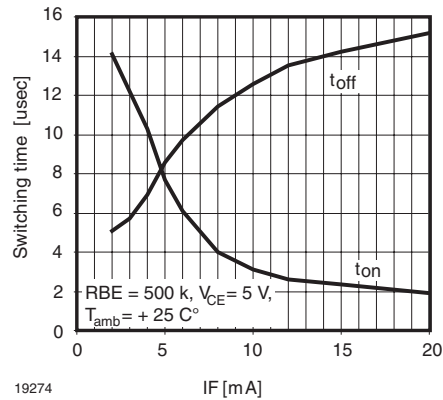

19274

Figure 14. Switching Time vs. IF

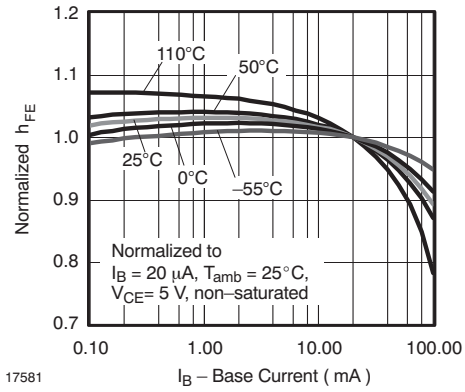

Figure 15. Normalized HFE vs. Base Current

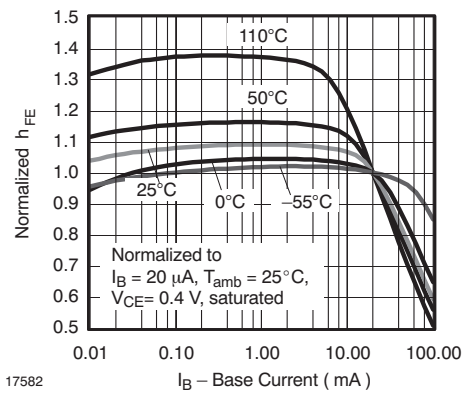

Figure 16. Normalized HFE vs. Base Current

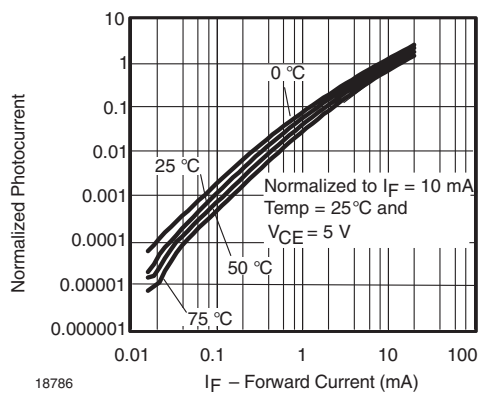

Figure 17. Normalized Photocurrent vs. Forward current

CNY117

Vishay Semiconductors



Package Dimensions in Inches (mm)

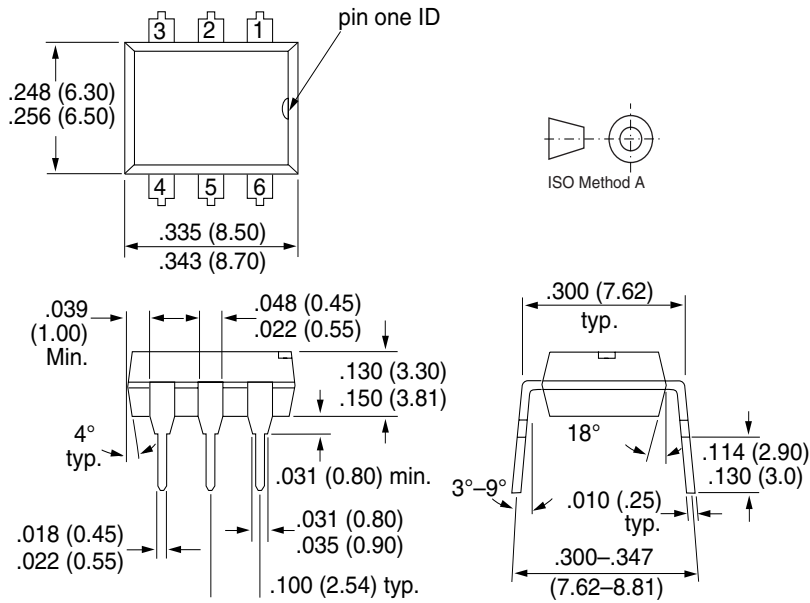

i178004



Ozone Depleting Substances Policy Statement

It is the policy of Vishay Semiconductor GmbH to

1. Meet all present and future national and international statutory requirements.
2. Regularly and continuously improve the performance of our products, processes, distribution and operating systems with respect to their impact on the health and safety of our employees and the public, as well as their impact on the environment.

It is particular concern to control or eliminate releases of those substances into the atmosphere which are known as ozone depleting substances (ODSs).

The Montreal Protocol (1987) and its London Amendments (1990) intend to severely restrict the use of ODSs and forbid their use within the next ten years. Various national and international initiatives are pressing for an earlier ban on these substances.

Vishay Semiconductor GmbH has been able to use its policy of continuous improvements to eliminate the use of ODSs listed in the following documents.

1. Annex A, B and list of transitional substances of the Montreal Protocol and the London Amendments respectively
2. Class I and II ozone depleting substances in the Clean Air Act Amendments of 1990 by the Environmental Protection Agency (EPA) in the USA
3. Council Decision 88/540/EEC and 91/690/EEC Annex A, B and C (transitional substances) respectively.

Vishay Semiconductor GmbH can certify that our semiconductors are not manufactured with ozone depleting substances and do not contain such substances.

We reserve the right to make changes to improve technical design and may do so without further notice.

Parameters can vary in different applications. All operating parameters must be validated for each customer application by the customer. Should the buyer use Vishay Semiconductors products for any unintended or unauthorized application, the buyer shall indemnify Vishay Semiconductors against all claims, costs, damages, and expenses, arising out of, directly or indirectly, any claim of personal damage, injury or death associated with such unintended or unauthorized use.

Vishay Semiconductor GmbH, P.O.B. 3535, D-74025 Heilbronn, Germany
Telephone: 49 (0)7131 67 2831, Fax number: 49 (0)7131 67 2423