



3A DUAL HIGH-SPEED POWER MOSFET DRIVERS

FEATURES

- High Peak Output Current 3A
- Wide Operating Range 4.5V to 18V
- High Capacitive Load Drive Capability 1800pF in 25nsec
- Short Delay Times <40nsec Typ.
- Matched Rise/Fall Times
- Low Supply Current
 - With Logic "1" Input 3.5mA
 - With Logic "0" Input 350µA
- Low Output Impedance 3.5Ω Typ.
- Latch-Up Protected ..Will Withstand 1.5A Reverse Current
- Logic Input Will Withstand Negative Swing Up to 5V
- ESD Protected4kV
- Pinouts Same as TC1426/27/28; TC4426/27/28

GENERAL DESCRIPTION

The TC4423/4424/4425 are higher output current versions of the new TC4426/4427/4428 buffer/drivers, which, in turn, are improved versions of the earlier TC426/427/428 series. All three families are pin-compatible. The TC4423/4424/4425 drivers are capable of giving reliable service in far more demanding electrical environments than their antecedents.

Although primarily intended for driving power MOSFETs, the TC4423/4424/4425 drivers are equally well-suited to driving any other load (capacitive, resistive, or inductive) which requires a low impedance driver capable of high peak currents and fast switching times. For example, heavily loaded clock lines, coaxial cables, or piezoelectric transducers can all be driven from the TC4423/4424/4425. The only known limitation on loading is the total power dissipated in the driver must be kept within the maximum power dissipation limits of the package.

ORDERING INFORMATION

Part No.	Package	Temperature Range
TC4423COE	16-Pin SOIC (Wide)	0°C to +70°C
TC4423CPA	8-Pin Plastic DIP	0°C to +70°C
TC4423EOE	16-Pin SOIC (Wide)	- 40°C to +85°C
TC4423EPA	8-Pin Plastic DIP	- 40°C to +85°C
TC4423MJA	8-Pin CerDIP	- 55°C to +125°C
TC4424COE	16-Pin SOIC (Wide)	0°C to +70°C
TC4424CPA	8-Pin Plastic DIP	0°C to +70°C
TC4424MJA	8-Pin CerDIP	- 55°C to +125°C

Part No	Package	Temperature Range
TC4424EOE	16-Pin SO Wide	- 40°C to +85°C
TC4424EPA	8-Pin Plastic DIP	- 40°C to +85°C
TC4425MJA	8-Pin CerDIP	- 55°C to +125°C
TC4425COE	16-Pin SO Wide	0°C to +70°C
TC4425CPA	8-Pin Plastic DIP	0°C to +70°C
TC4425EOE	16-Pin SO Wide	- 40°C to +85°C
TC4425EPA	8-Pin Plastic DIP	- 40°C to +85°C

FUNCTIONAL BLOCK DIAGRAM

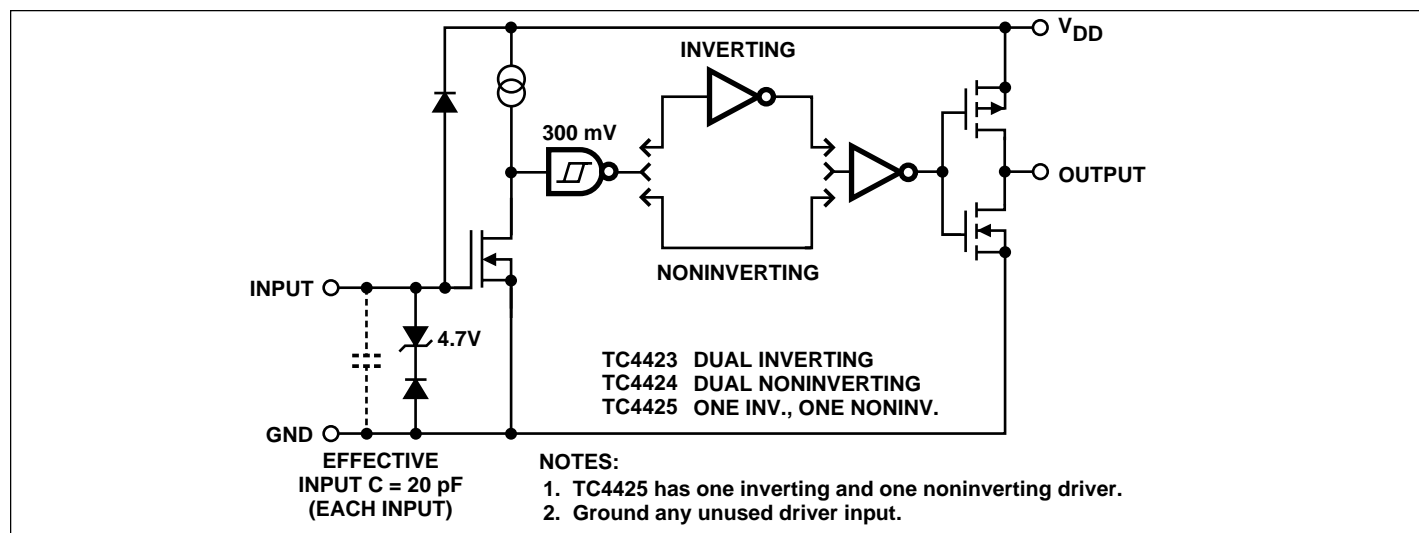

3A DUAL HIGH-SPEED POWER MOSFET DRIVERS

TC4423
TC4424
TC4425

ABSOLUTE MAXIMUM RATINGS

Supply Voltage	+22V
Input Voltage, IN A or IN B	$V_{DD} + 0.3V$ to GND – 5.0V
Maximum Chip Temperature	+150°C
Storage Temperature Range	– 65°C to +150°C
Lead Temperature (Soldering, 10 sec)	+300°C
Package Thermal Resistance	
CerDIP $R_{\theta J-A}$	150°C/W
CerDIP $R_{\theta J-C}$	55°C/W
PDIP $R_{\theta J-A}$	125°C/W
PDIP $R_{\theta J-C}$	45°C/W

SOIC $R_{\theta J-A}$	155°C/W
SOIC $R_{\theta J-C}$	75°C/W
Operating Temperature Range	
C Version	0°C to +70°C
I Version	– 25°C to +85°C
E Version	– 40°C to +85°C
M Version	– 55°C to +125°C
Package Power Dissipation ($T_A \leq 70^\circ\text{C}$)	
Plastic DIP	730mW
CerDIP	800mW
SOIC	470mW

PIN CONFIGURATIONS

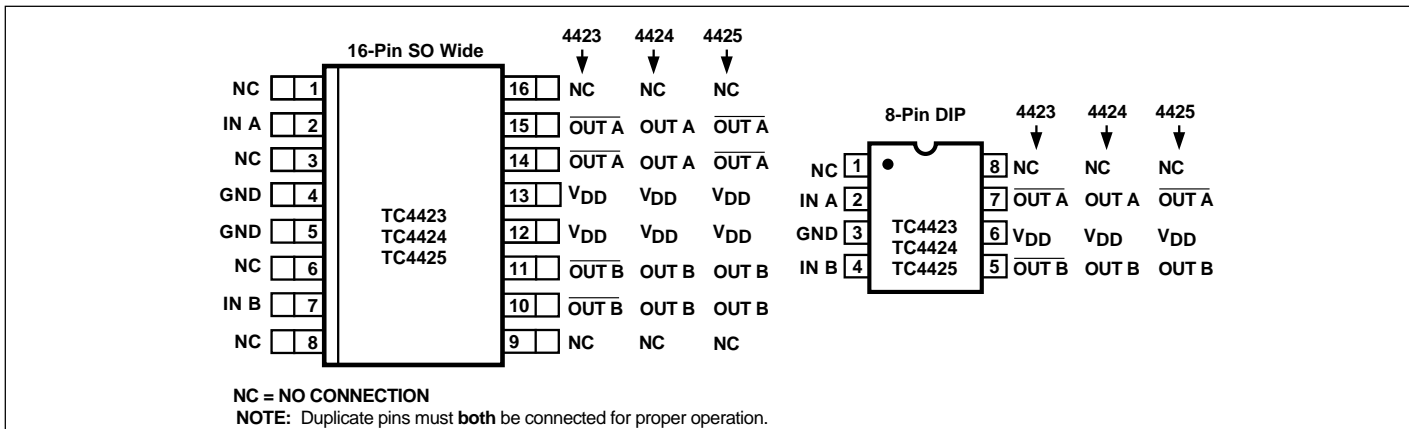

ELECTRICAL CHARACTERISTICS: $T_A = +25^\circ\text{C}$ with $4.5V \leq V_{DD} \leq 18V$, unless otherwise specified.

Symbol	Parameter	Test Conditions	Min	Typ	Max	Unit
Input						
V_{OH}	Logic 1 High Input Voltage		2.4	—	—	V
V_{IL}	Logic 0 Low Input Voltage		—	—	0.8	V
I_{IN}	Input Current	$0V \leq V_{IN} \leq V_{DD}$	– 1	—	1	μA
Output						
V_{OH}	High Output Voltage		$V_{DD} - 0.025$	—	—	V
V_{OL}	Low Output Voltage		—	—	0.025	V
R_O	Output Resistance, High	$I_{OUT} = 10\text{ mA}, V_{DD} = 18V$	—	2.8	5	Ω
R_O	Output Resistance, Low	$I_{OUT} = 10\text{ mA}, V_{DD} = 18V$	—	3.5	5	Ω
I_{PK}	Peak Output Current		—	3	—	A
I_{REV}	Latch-Up Protection Withstand Reverse Current	Duty Cycle $\leq 2\%$ $t \leq 300\ \mu\text{sec}$	1.5	—	—	A
Switching Time (Note 1)						
t_R	Rise Time	Figure 1, $C_L = 1800\text{pF}$	—	23	35	nsec
t_F	Fall Time	Figure 1, $C_L = 1800\text{pF}$	—	25	35	nsec
t_{D1}	Delay Time	Figure 1, $C_L = 1800\text{pF}$	—	33	75	nsec
t_{D2}	Delay Time	Figure 1, $C_L = 1800\text{pF}$	—	38	75	nsec
Power Supply						
I_S	Power Supply Current	$V_{IN} = 3V$ (Both Inputs) $V_{IN} = 0V$ (Both Inputs)	—	1.5 0.15	2.5 0.25	mA mA

3A DUAL HIGH-SPEED POWER MOSFET DRIVERS

TC4423
TC4424
TC4425

ELECTRICAL CHARACTERISTICS (Cont.) Over operating temperature range with $4.5V \leq V_{DD} \leq 18V$, unless otherwise specified.

Symbol	Parameter	Test Conditions	Min	Typ	Max	Unit
Input						
V_{IH}	Logic 1 High Input Voltage		2.4	—	—	V
V_{IL}	Logic 0 Low Input Voltage		—	—	0.8	V
I_{IN}	Input Current $0V \leq V_{IN} \leq V_{DD}$		- 10	—	10	μA
Output						
V_{OH}	High Output Voltage		$V_{DD} - 0.025$	—	—	V
V_{OL}	Low Output Voltage		—	—	0.025	V
R_{OH}	Output Resistance, High	$I_{OUT} = 10\text{ mA}, V_{DD} = 18V$	—	3.7	8	Ω
R_{OL}	Output Resistance, Low	$I_{OUT} = 10\text{ mA}, V_{DD} = 18V$	—	4.3	8	Ω
I_{PK}	Peak Output Current		—	3	—	A
I_{REV}	Latch-Up Protection Withstand Reverse Current	Duty Cycle $\leq 2\%$ $t \leq 300\ \mu\text{sec}$	1.5	—	—	A
Switching Time (Note 1)						
t_R	Rise Time	Figure 1, $C_L = 1800\text{pF}$	—	28	60	nsec
t_F	Fall Time	Figure 1, $C_L = 1800\text{pF}$	—	32	60	nsec
t_{D1}	Delay Time	Figure 1, $C_L = 1800\text{pF}$	—	32	100	nsec
t_{D2}	Delay Time	Figure 1, $C_L = 1800\text{pF}$	—	38	100	nsec
Power Supply						
I_S	Power Supply Current	$V_{IN} = 3V$ (Both Inputs) $V_{IN} = 0V$ (Both Inputs)	—	2 0.2	3.5 0.3	mA mA

NOTE: 1. Switching times guaranteed by design.

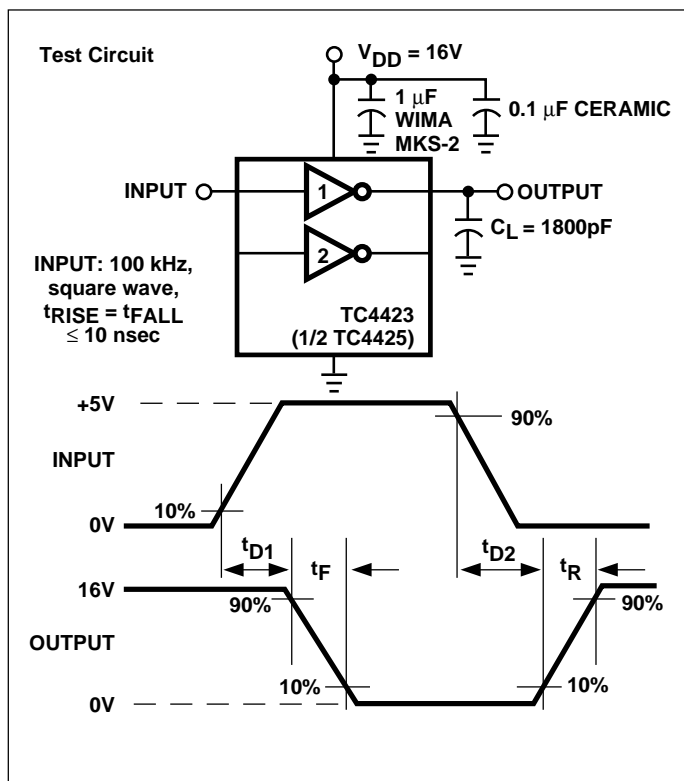

Figure 1. Inverting Driver Switching Time

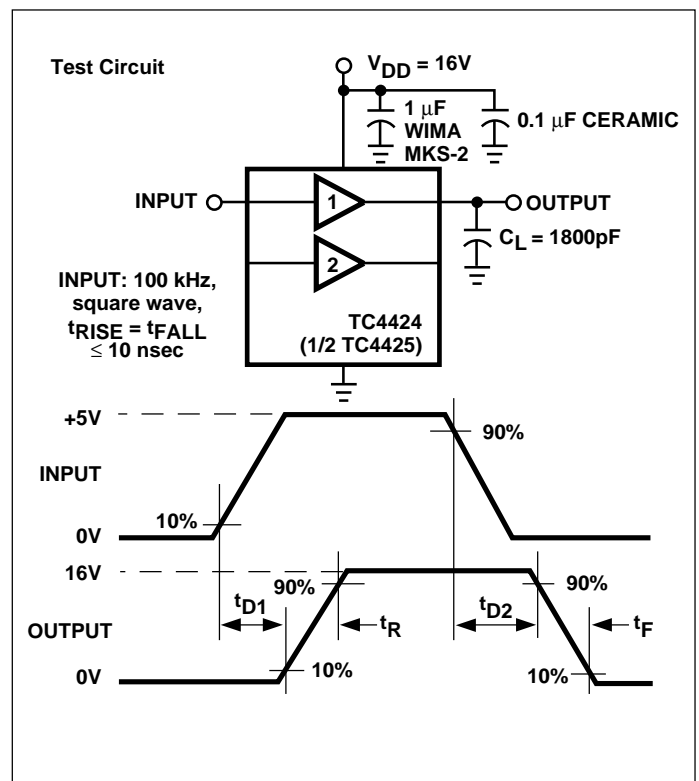
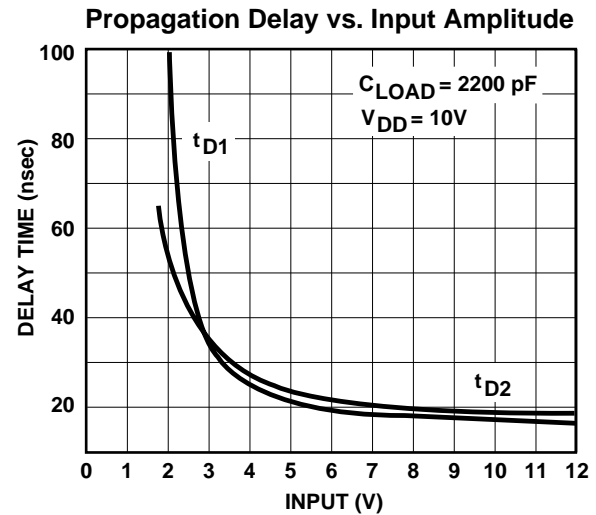
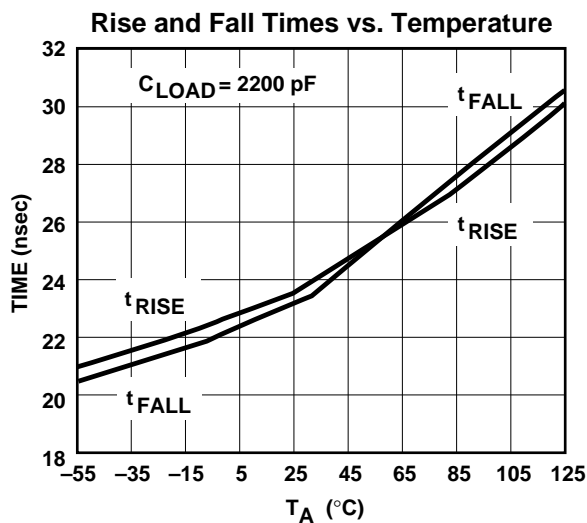
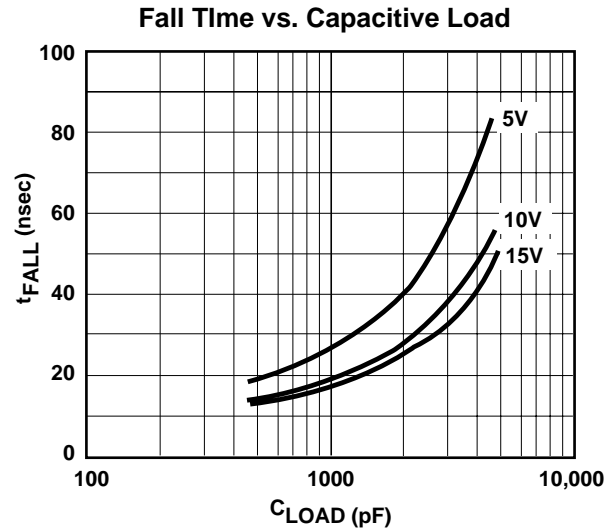
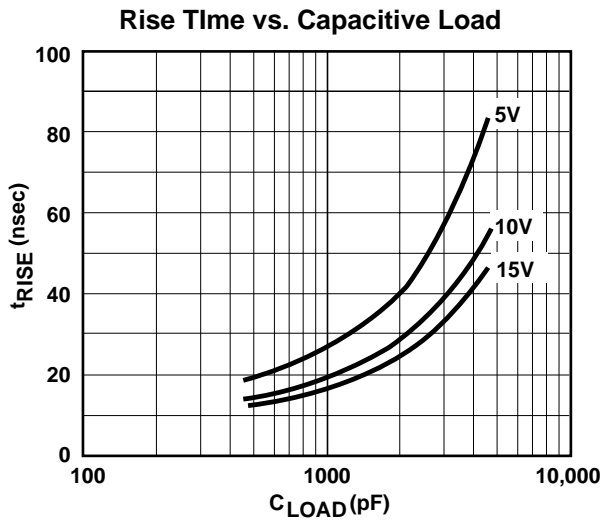
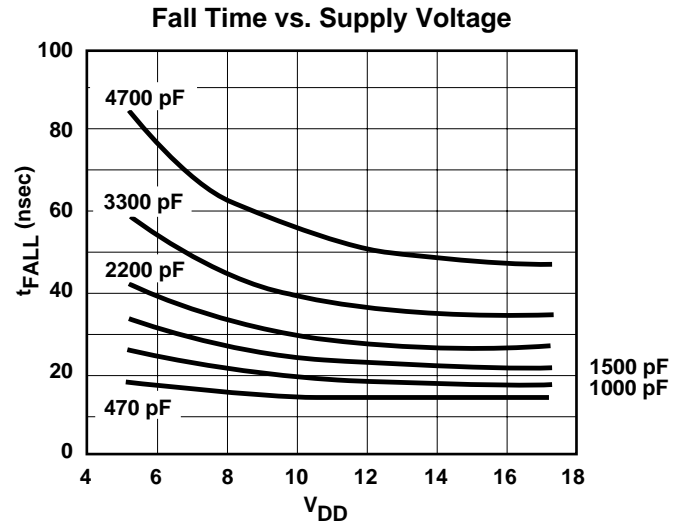
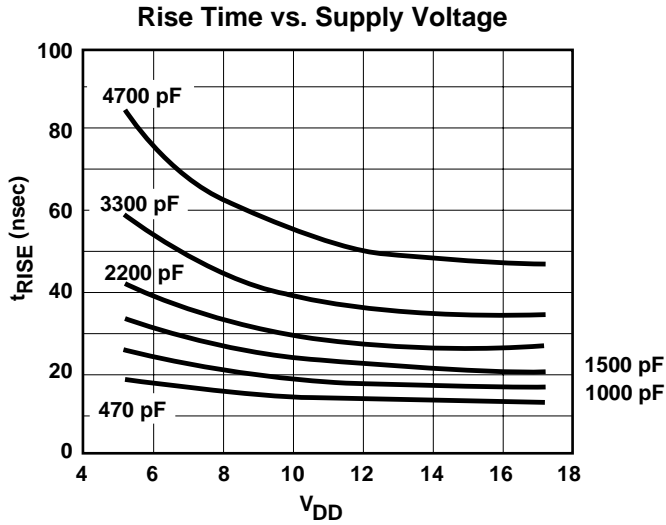

Figure 2. Noninverting Driver Switching Time

3A DUAL HIGH-SPEED POWER MOSFET DRIVERS

TC4423
TC4424
TC4425

TYPICAL CHARACTERISTICS



3A DUAL HIGH-SPEED POWER MOSFET DRIVERS

TC4423
TC4424
TC4425

TYPICAL CHARACTERISTICS (Cont.)

Propagation Delay Time vs. Supply Voltage

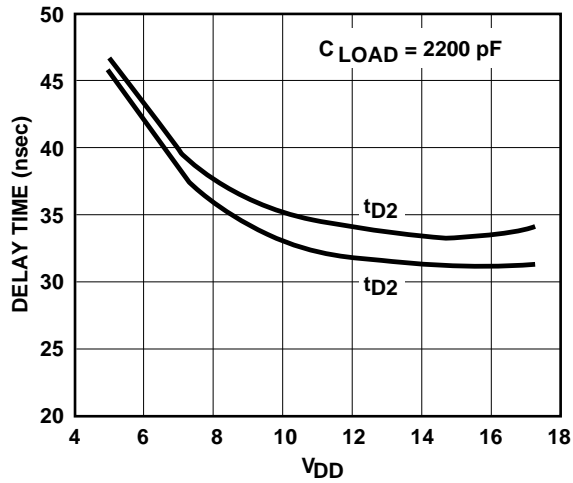

Delay Time vs. Temperature

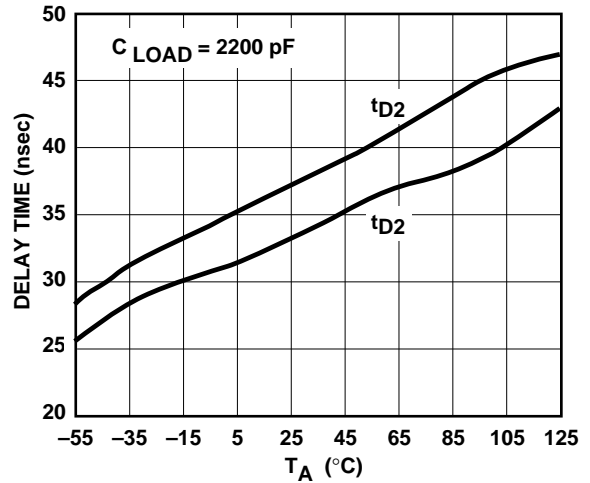

Quiescent Current vs. Supply Voltage

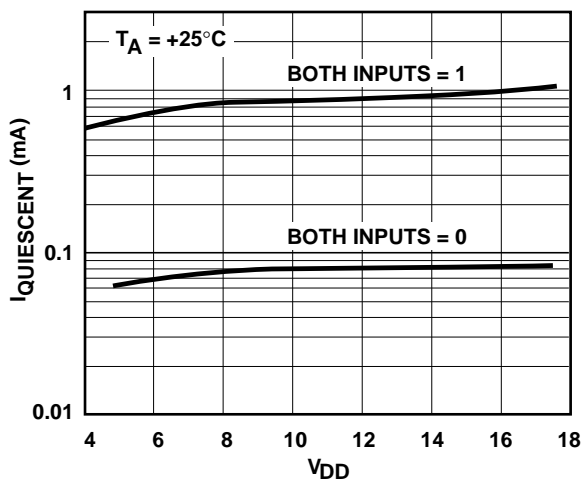

Quiescent Current vs. Temperature

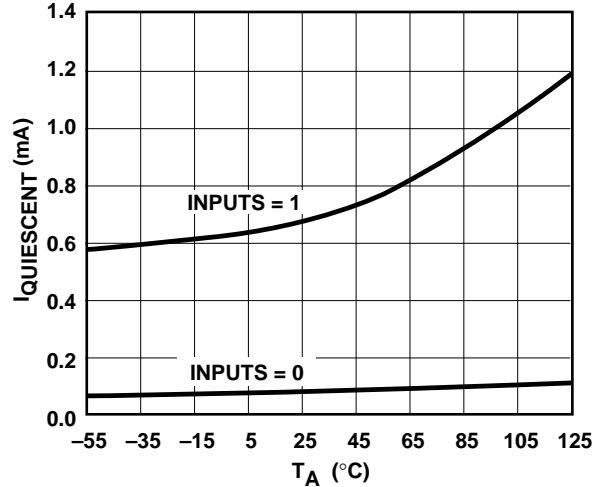

Output Resistance (Output High) vs. Supply Voltage

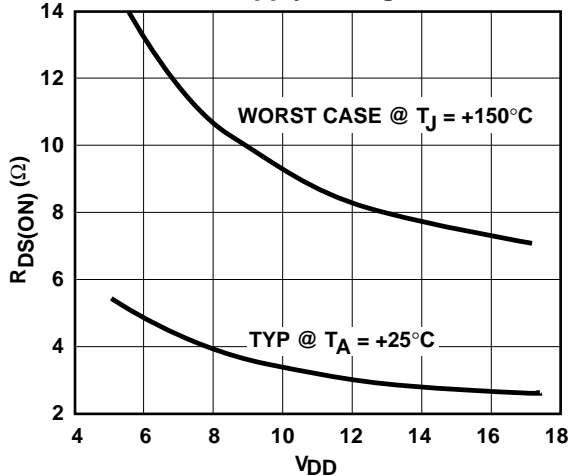

Output Resistance (Output Low) vs. Supply Voltage

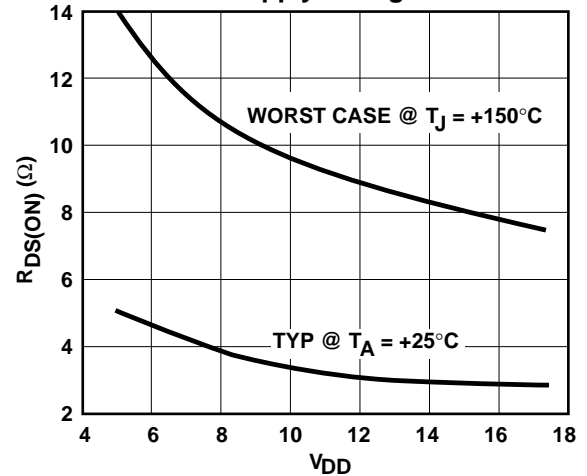

3A DUAL HIGH-SPEED POWER MOSFET DRIVERS

TC4423
TC4424
TC4425

SUPPLY CURRENT CHARACTERISTICS (Load on Single Output Only)

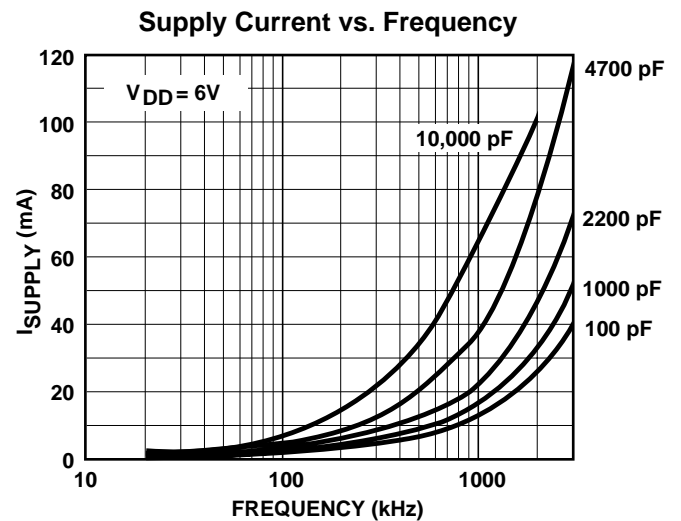
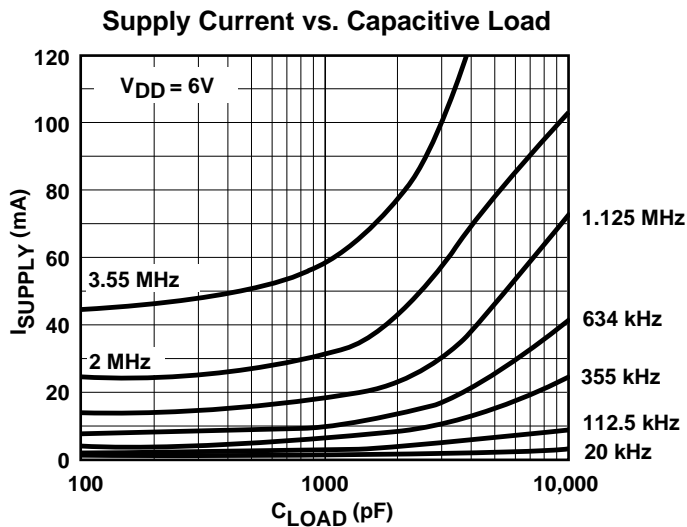
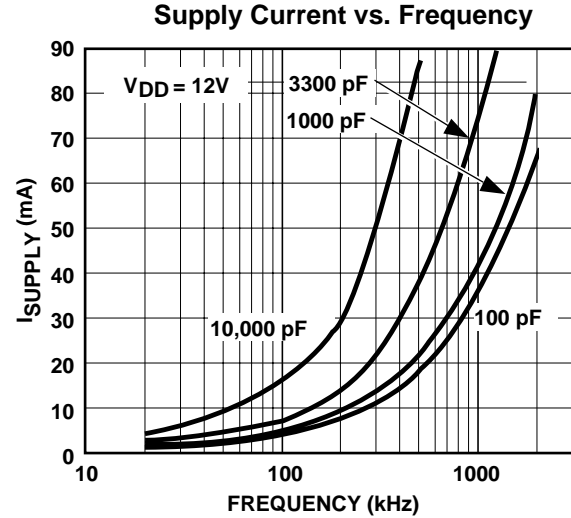
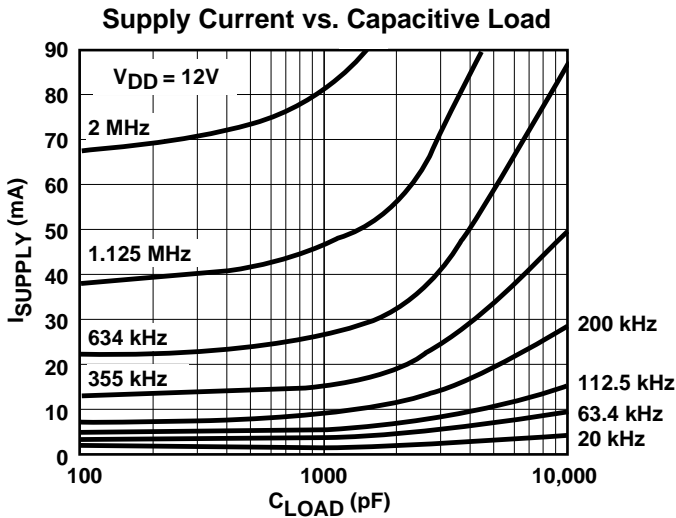
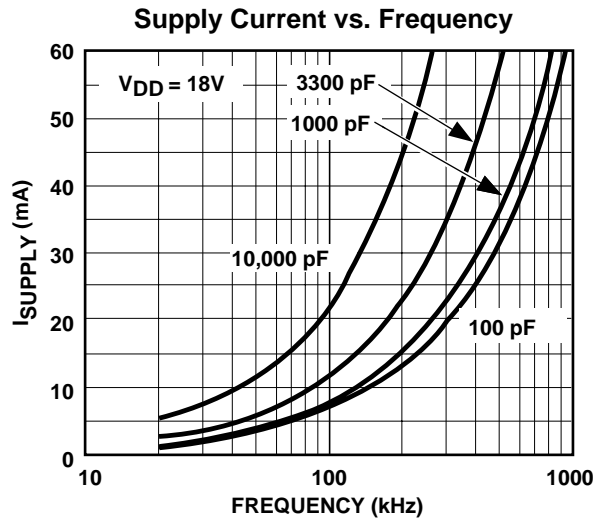
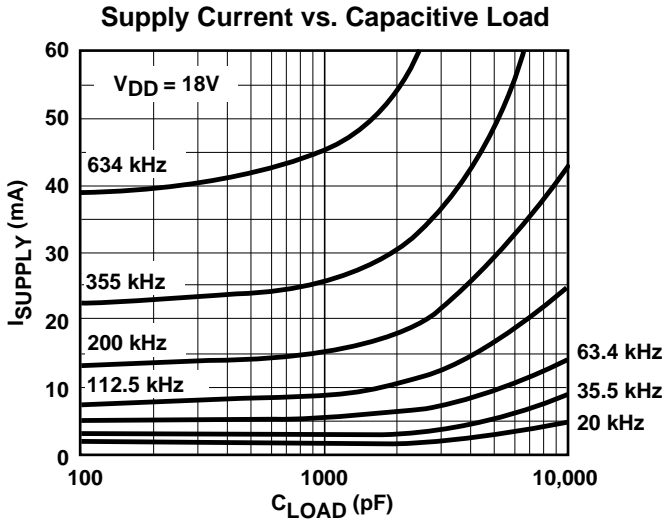

3A DUAL HIGH-SPEED POWER MOSFET DRIVERS

TC4423
TC4424
TC4425

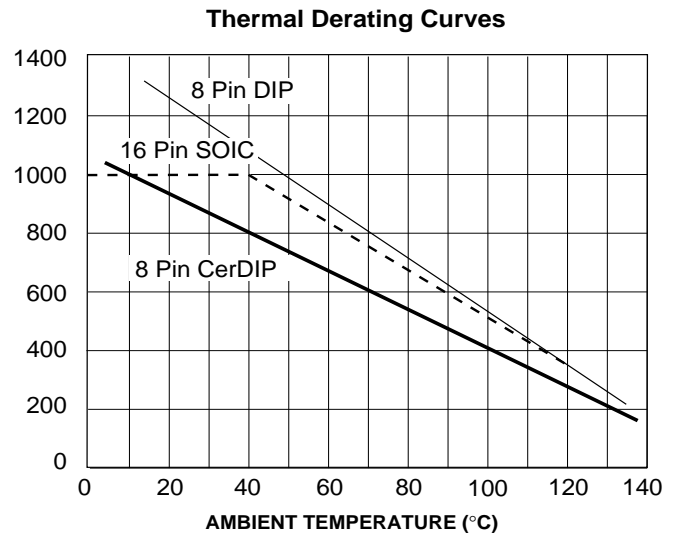
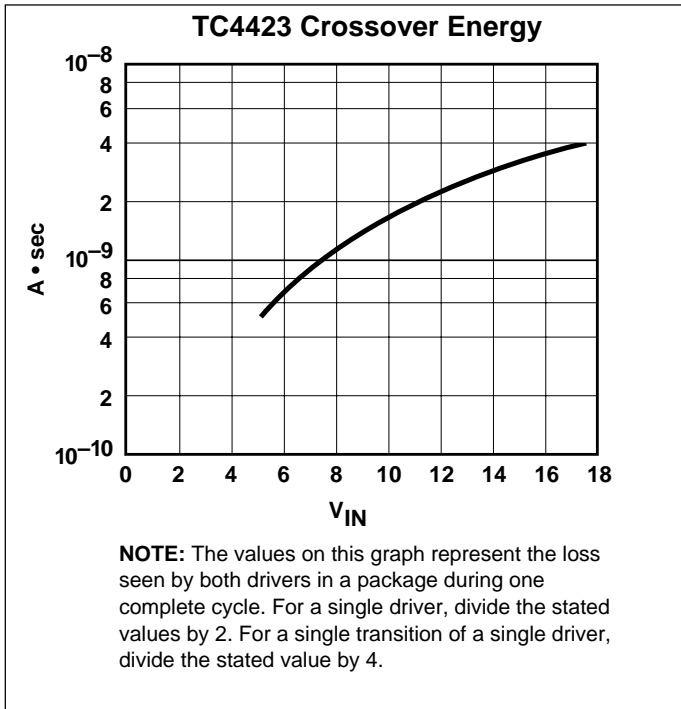

*Static-sensitive device. Unused devices must be stored in conductive material. Protect devices from static discharge and static fields. Stresses above those listed under Absolute Maximum Ratings (See page 2) may cause permanent damage to the device. These are stress ratings only and functional operation of the device at these or any other conditions above those indicated in the operational sections of the specifications is not implied. Exposure to Absolute Maximum Rating Conditions for extended periods may affect device reliability.

PACKAGE DIMENSIONS

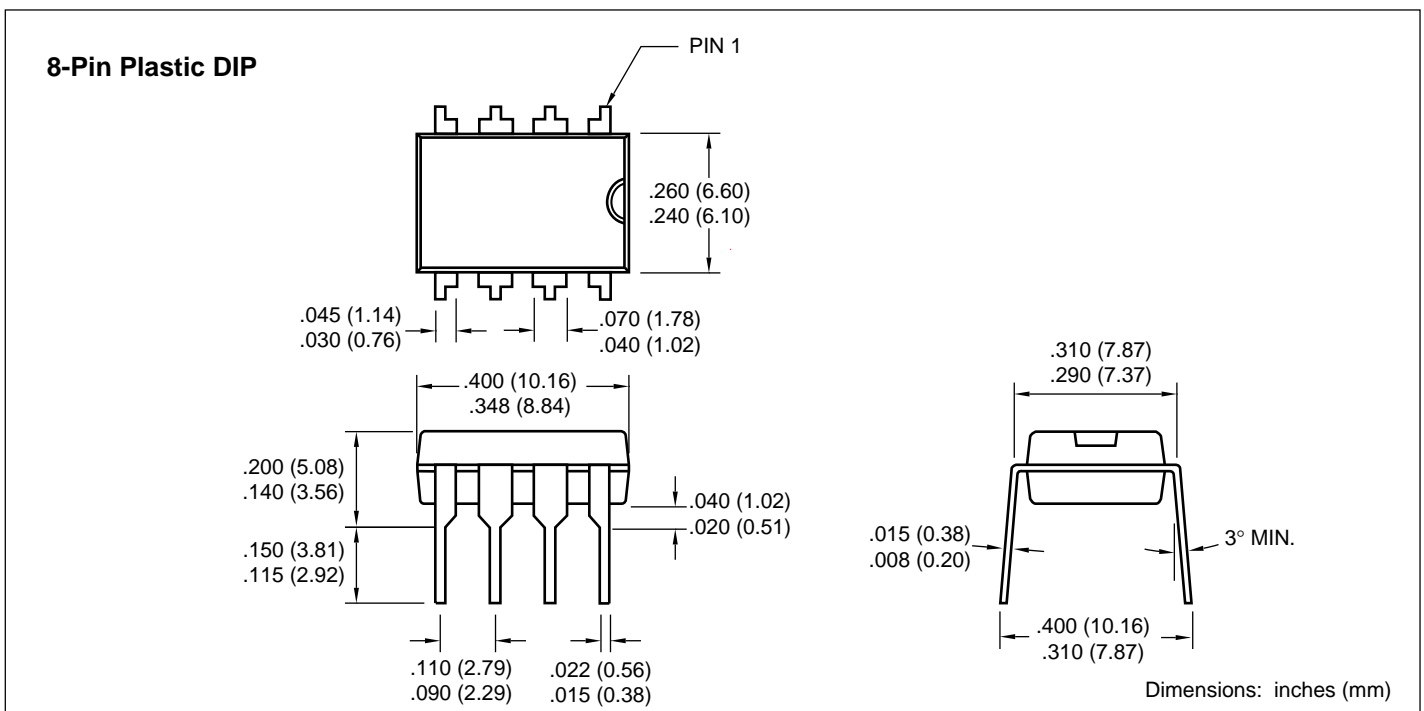

3A DUAL HIGH-SPEED POWER MOSFET DRIVERS

TC4423
TC4424
TC4425

PACKAGE DIMENSIONS (Cont.)

8-Pin CerDIP

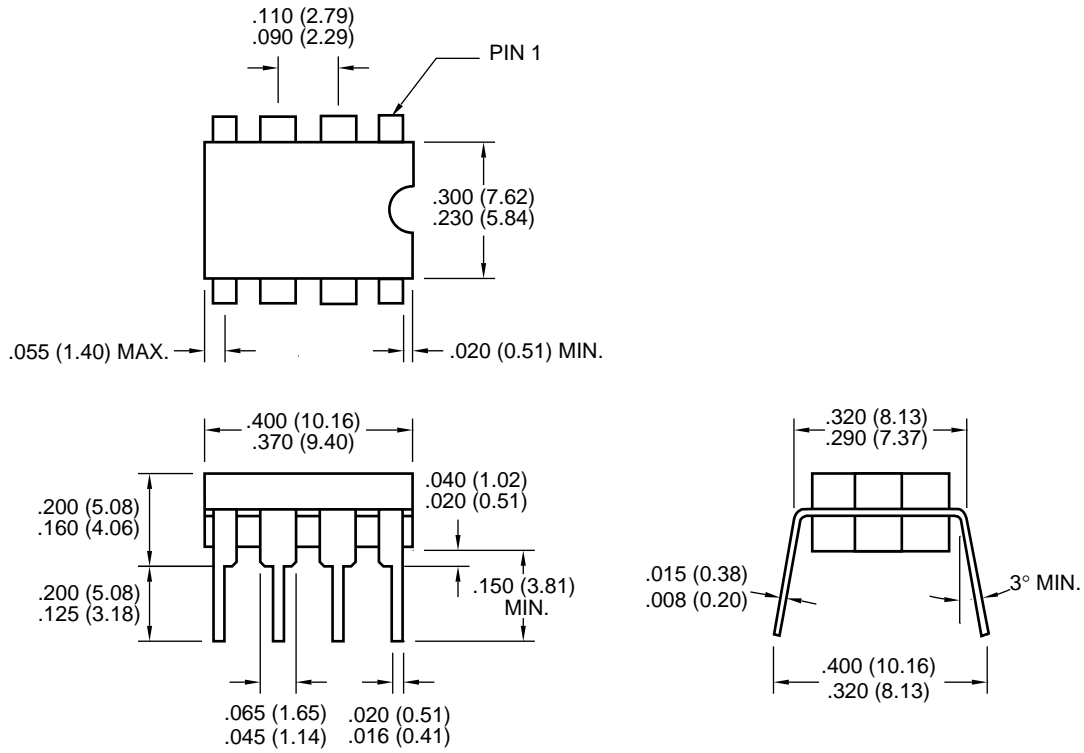

16-Pin Plastic SOIC (Wide)

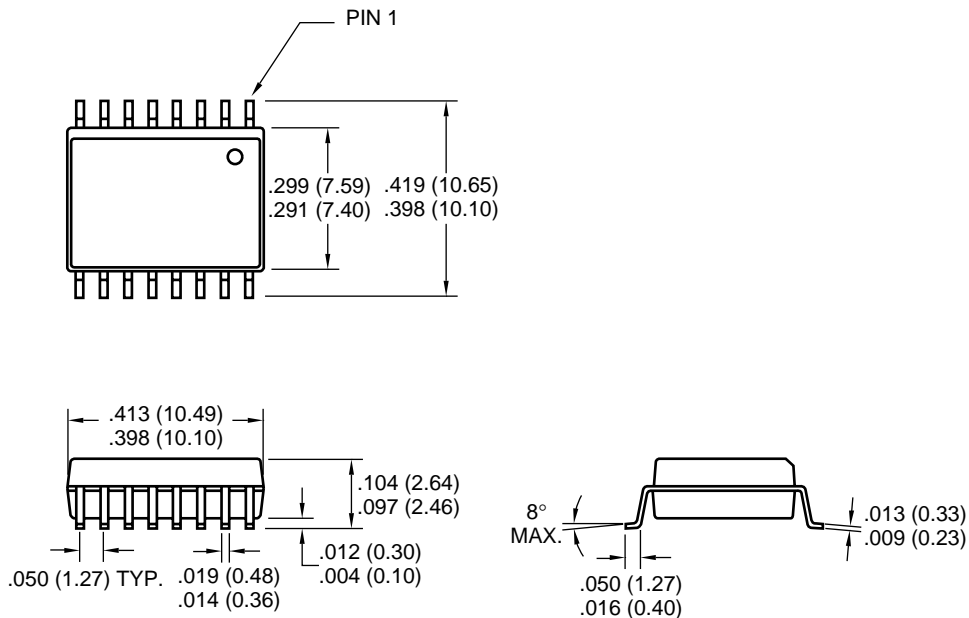

Dimensions: inches (mm)



WORLDWIDE SALES AND SERVICE

AMERICAS

Corporate Office

2355 West Chandler Blvd.
Chandler, AZ 85224-6199
Tel: 480-792-7200 Fax: 480-792-7277
Technical Support: 480-792-7627
Web Address: <http://www.microchip.com>

Rocky Mountain

2355 West Chandler Blvd.
Chandler, AZ 85224-6199
Tel: 480-792-7966 Fax: 480-792-7456

Atlanta

500 Sugar Mill Road, Suite 200B
Atlanta, GA 30350
Tel: 770-640-0034 Fax: 770-640-0307

Austin

Analog Product Sales
8303 MoPac Expressway North
Suite A-201
Austin, TX 78759
Tel: 512-345-2030 Fax: 512-345-6085

Boston

2 Lan Drive, Suite 120
Westford, MA 01886
Tel: 978-692-3848 Fax: 978-692-3821

Boston

Analog Product Sales
Unit A-8-1 Millbrook Tarry Condominium
97 Lowell Road
Concord, MA 01742
Tel: 978-371-6400 Fax: 978-371-0050

Chicago

333 Pierce Road, Suite 180
Itasca, IL 60143
Tel: 630-285-0071 Fax: 630-285-0075

Dallas

4570 Westgrove Drive, Suite 160
Addison, TX 75001
Tel: 972-818-7423 Fax: 972-818-2924

Dayton

Two Prestige Place, Suite 130
Miamisburg, OH 45342
Tel: 937-291-1654 Fax: 937-291-9175

Detroit

Tri-Atria Office Building
32255 Northwestern Highway, Suite 190
Farmington Hills, MI 48334
Tel: 248-538-2250 Fax: 248-538-2260

Los Angeles

18201 Von Karman, Suite 1090
Irvine, CA 92612
Tel: 949-263-1888 Fax: 949-263-1338

Mountain View

Analog Product Sales
1300 Terra Bella Avenue
Mountain View, CA 94043-1836
Tel: 650-968-9241 Fax: 650-967-1590

New York

150 Motor Parkway, Suite 202
Hauppauge, NY 11788
Tel: 631-273-5305 Fax: 631-273-5335

San Jose

Microchip Technology Inc.
2107 North First Street, Suite 590
San Jose, CA 95131
Tel: 408-436-7950 Fax: 408-436-7955

Toronto

6285 Northam Drive, Suite 108
Mississauga, Ontario L4V 1X5, Canada
Tel: 905-673-0699 Fax: 905-673-6509

ASIA/PACIFIC

China - Beijing

Microchip Technology Beijing Office
Unit 915
New China Hong Kong Manhattan Bldg.
No. 6 Chaoyangmen Beidajie
Beijing, 100027, No. China
Tel: 86-10-85282100 Fax: 86-10-85282104

China - Shanghai

Microchip Technology Shanghai Office
Room 701, Bldg. B
Far East International Plaza
No. 317 Xian Xia Road
Shanghai, 200051
Tel: 86-21-6275-5700 Fax: 86-21-6275-5060

Hong Kong

Microchip Asia Pacific
RM 2101, Tower 2, Metroplaza
223 Hing Fong Road
Kwai Fong, N.T., Hong Kong
Tel: 852-2401-1200 Fax: 852-2401-3431

India

Microchip Technology Inc.
India Liaison Office
Divyasree Chambers
1 Floor, Wing A (A3/A4)
No. 11, O'Shaughnessey Road
Bangalore, 560 025, India
Tel: 91-80-2290061 Fax: 91-80-2290062

Japan

Microchip Technology Intl. Inc.
Benex S-1 6F
3-18-20, Shinyokohama
Kohoku-Ku, Yokohama-shi
Kanagawa, 222-0033, Japan
Tel: 81-45-471-6166 Fax: 81-45-471-6122

Korea

Microchip Technology Korea
168-1, Youngbo Bldg. 3 Floor
Samsung-Dong, Kangnam-Ku
Seoul, Korea
Tel: 82-2-554-7200 Fax: 82-2-558-5934

ASIA/PACIFIC (continued)

Singapore

Microchip Technology Singapore Pte Ltd.
200 Middle Road
#07-02 Prime Centre
Singapore, 188980
Tel: 65-334-8870 Fax: 65-334-8850

Taiwan

Microchip Technology Taiwan
11F-3, No. 207
Tung Hua North Road
Taipei, 105, Taiwan
Tel: 886-2-2717-7175 Fax: 886-2-2545-0139

EUROPE

Australia

Microchip Technology Australia Pty Ltd
Suite 22, 41 Rawson Street
Epping 2121, NSW
Australia
Tel: 61-2-9868-6733 Fax: 61-2-9868-6755

Denmark

Microchip Technology Denmark ApS
Regus Business Centre
Lautrup hof 1-3
Ballerup DK-2750 Denmark
Tel: 45 4420 9895 Fax: 45 4420 9910

France

Arizona Microchip Technology SARL
Parc d'Activite du Moulin de Massy
43 Rue du Saule Trapu
Batiment A - 1er Etage
91300 Massy, France
Tel: 33-1-69-53-63-20 Fax: 33-1-69-30-90-79

Germany

Arizona Microchip Technology GmbH
Gustav-Heinemann Ring 125
D-81739 Munich, Germany
Tel: 49-89-627-144 0 Fax: 49-89-627-144-44

Germany

Analog Product Sales
Lochhamer Strasse 13
D-82152 Martinsried, Germany
Tel: 49-89-895650-0 Fax: 49-89-895650-22

Italy

Arizona Microchip Technology SRL
Centro Direzionale Colleoni
Palazzo Taurus 1 V. Le Colleoni 1
20041 Agrate Brianza
Milan, Italy
Tel: 39-039-65791-1 Fax: 39-039-6899883

United Kingdom

Arizona Microchip Technology Ltd.
505 Eskdale Road
Winnersh Triangle
Wokingham
Berkshire, England RG41 5TU
Tel: 44 118 921 5869 Fax: 44-118 921-5820

All rights reserved. © 2001 Microchip Technology Incorporated. Printed in the USA. 1/01  Printed on recycled paper.

01/09/01

Information contained in this publication regarding device applications and the like is intended through suggestion only and may be superseded by updates. It is your responsibility to ensure that your application meets with your specifications. No representation or warranty is given and no liability is assumed by Microchip Technology Incorporated with respect to the accuracy or use of such information, or infringement of patents or other intellectual property rights arising from such use or otherwise. Use of Microchip's products as critical components in life support systems is not authorized except with express written approval by Microchip. No licenses are conveyed, implicitly or otherwise, except as maybe explicitly expressed herein, under any intellectual property rights. The Microchip logo and name are registered trademarks of Microchip Technology Inc. in the U.S.A. and other countries. All rights reserved. All other trademarks mentioned herein are the property of their respective companies.