



Silicon Oscillator with Low-Power Frequency Switching and Reset Output

MAX7378

General Description

The MAX7378 dual-speed silicon oscillator with reset, is a replacement for ceramic resonators, crystals, crystal-oscillator modules, and discrete reset circuits. The MAX7378 provides the primary and secondary clock source and reset function for microcontrollers in 3V, 3.3V, and 5V applications. The MAX7378 features a factory-programmed high-speed oscillator, a 32.768kHz oscillator, a clock selector input, and a microprocessor (μ P) power-on-reset (POR) supervisor. The clock output can be switched at any time between the high-speed clock and the 32.768kHz clock for low-power operation. Switchover is synchronized internally to provide glitch-free clock switching.

Unlike typical crystal and ceramic resonator oscillator circuits, the MAX7378 is resistant to vibration and EMI. The high-output-drive current and absence of high-impedance nodes make the oscillator less susceptible to dirty or humid operating conditions. With a wide operating temperature range as standard, the MAX7378 is a good choice for demanding home appliance, industrial, and automotive environments.

The MAX7378 is available in an 8-pin μ MAX[®] package. Refer to the MAX7384 data sheet for frequencies ≥ 10 MHz. The MAX7378 standard operating temperature range is -40°C to $+125^{\circ}\text{C}$. See the *Applications Information* section for the extended operating temperature range.

Applications

- White Goods
- Automotive
- Consumer Products
- Appliances and Controls
- Handheld Products
- Portable Equipment
- Microcontroller (μ C) Systems

Pin Configuration appears at end of data sheet.

Features

- ◆ 2.7V to 5.5V Operation
- ◆ Accurate High-Speed Oscillator: 600kHz to 10MHz
- ◆ Accurate Low-Speed 32kHz Oscillator
- ◆ Glitch-Free Switch Between High Speed and Low Speed at Any Time
- ◆ Reset Output Holds the μ C in Reset for 100 μ s After Clock Startup
- ◆ ± 10 mA Clock-Output Drive Capability
- ◆ 2% Initial Accuracy
- ◆ ± 50 ppm/ $^{\circ}\text{C}$ Temperature Coefficient
- ◆ 50% $\pm 7\%$ Output Duty Cycle
- ◆ 5ns Output Rise and Fall Time
- ◆ Low Jitter: 160ps (Peak-to-Peak) at 8MHz
- ◆ 2.4mA Fast-Mode Operating Current (8MHz)
- ◆ 11 μ A Slow-Mode Operating Current (32kHz)
- ◆ -40°C to $+125^{\circ}\text{C}$ Temperature Range

Ordering Information

PART	TEMP RANGE	RESET OUTPUT	PIN-PACKAGE
MAX7378A ___	-40°C to $+125^{\circ}\text{C}$	Active high push-pull	8 μ MAX
MAX7378B ___	-40°C to $+125^{\circ}\text{C}$	Active low push-pull	8 μ MAX
MAX7378C ___	-40°C to $+125^{\circ}\text{C}$	Open drain	8 μ MAX

Standard version is shown in bold. The first letter after the part number designates the reset output option. Insert the letter corresponding to the desired reset threshold level from Table 1 in the next position. Insert the two-letter code from Table 2 in the remaining two positions for the desired frequency range. See Table 3 for standard part numbers.

Typical Application Circuit

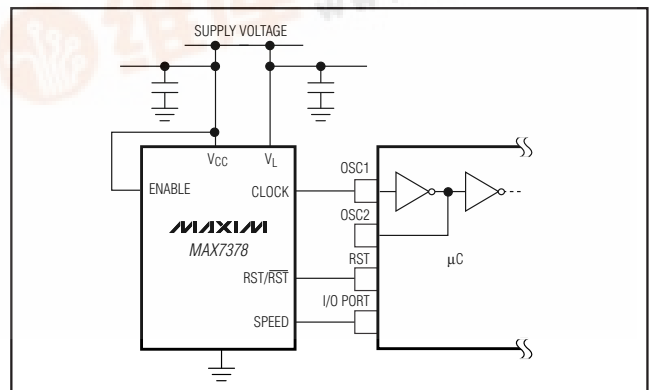

μ MAX is a registered trademark of Maxim Integrated Products, Inc.

Silicon Oscillator with Low-Power Frequency Switching and Reset Output

ABSOLUTE MAXIMUM RATINGS

V_{CC} to GND-0.3V to +6V
 All Other Pins to GND-0.3V to (V_{CC} + 0.3V)
 CLOCK Current±10mA
 Continuous Power Dissipation (T_A = +70°C)
 8-Pin μMAX (derate 4.5mW/°C above +70°C)....362mW (U8-1)

Operating Temperature Range-40°C to +135°C
 Junction Temperature+150°C
 Storage Temperature Range.....-60°C to +150°C
 Lead Temperature (soldering, 10s).....+300°C

Stresses beyond those listed under "Absolute Maximum Ratings" may cause permanent damage to the device. These are stress ratings only, and functional operation of the device at these or any other conditions beyond those indicated in the operational sections of the specifications is not implied. Exposure to absolute maximum rating conditions for extended periods may affect device reliability.

ELECTRICAL CHARACTERISTICS

(V_{CC} = 2.7V to 5.5V, V_L = V_{CC}, T_A = -40°C to +125°C, unless otherwise noted. Typical values are at V_{CC} = 5V, T_A = +25°C.) (Note 1)

PARAMETER	SYMBOL	CONDITIONS	MIN	TYP	MAX	UNITS
Operating Supply Voltage	V _{CC}		2.7		5.5	V
Logic Output Supply Voltage	V _L	Must be connected to V _{CC}	2.7		5.5	V
Operating Supply Current	I _{CC} + I _L	f _{CLOCK} = 8MHz, no load		2.4	5.5	mA
	I _{CC} + I _L	f _{CLOCK} = 32.768kHz, no load		11	25	μA
Shutdown Current	I _{SHDN}	ENABLE = 0V; I _{CC} + I _L		3.0	7.5	μA
LOGIC INPUT (SPEED, ENABLE)						
Input High Voltage	V _{IH}		0.7 x V _{CC}			V
Input Low Voltage	V _{IL}				0.3 x V _{CC}	V
Input Current	I _{IN}				2	μA
CLOCK OUTPUT						
Output High Voltage	V _{OH}	V _L = 4.5V, I _{SOURCE} = 9mA	V _L - 0.4			V
		V _L = 2.7V, I _{SOURCE} = 2.5mA	V _L - 0.4			
Output Low Voltage	V _{OL}	V _L = 4.5V, I _{SINK} = 20mA			0.4	V
		V _L = 2.7V, I _{SINK} = 10mA			0.4	
Initial Fast CLOCK Frequency Accuracy	f _{FCLOCK}	V _{CC} = 5V, T _A = +25°C (Note 2)	-2		+2	%
		V _{CC} = 2.7V to 5.5V, T _A = +25°C	-4		+4	
Fast CLOCK Frequency Temperature Sensitivity		(Note 3)		±50	±325	ppm/°C
Initial Slow CLOCK Frequency Accuracy	f _{SCLOCK}	V _{CC} = 5V, T _A = +25°C	32.440	32.768	33.096	kHz
		V _{CC} = 2.7V to 5.5V, T _A = +25°C	31.785		33.751	
Slow CLOCK Frequency Temperature Sensitivity		(Note 3)		±50	±325	ppm/°C

Silicon Oscillator with Low-Power Frequency Switching and Reset Output

MAX7378

ELECTRICAL CHARACTERISTICS (continued)

(V_{CC} = 2.7V to 5.5V, V_L = V_{CC}, T_A = -40°C to +125°C, unless otherwise noted. Typical values are at V_{CC} = 5V, T_A = +25°C.) (Note 1)

PARAMETER	SYMBOL	CONDITIONS		MIN	TYP	MAX	UNITS
CLOCK Output Duty Cycle				43	50	57	%
CLOCK Output Jitter		Observation of 8MHz output for 20s using a 500MHz oscilloscope			160		psp-p
CLOCK Output Rise Time	t _R	10% to 90%			5		ns
CLOCK Output Fall Time	t _F	90% to 10%			5		ns
RST/RST OUTPUT							
Reset Threshold	V _{TH+}	V _{CC} rising	T _A = +25°C	V _{TH} - 1.5%		V _{TH} + 1.5%	V
			T _A = -40°C to +125°C	V _{TH} - 5%		V _{TH} + 5%	
Reset Hysteresis	V _{THYS}	V _{HYS} = ((V _{TH+}) - (V _{TH-}))/(V _{TH-}) x 100%			2.0		%
POR Delay		V _{CC} rising from 0V to (V _{TH} + 200mV) in 1μs			100		μs
Output High Voltage	V _{OH}	V _L = 4.5V, I _{SOURCE} = 9mA		V _L - 0.4			V
		V _L = 2.7V, I _{SOURCE} = 2.5mA		V _L - 0.4			
Output Low Voltage	V _{OL}	V _L = 4.5V, I _{SINK} = 20mA				0.4	V
		V _L = 2.7V, I _{SINK} = 10mA				0.4	

Note 1: All parameters are tested at T_A = +25°C. Specifications over temperature are guaranteed by design.

Note 2: The frequency is determined by part number selection. See the *Ordering Information*.

Note 3: Guaranteed by design. Not production tested.

Silicon Oscillator with Low-Power Frequency Switching and Reset Output

Typical Operating Characteristics

($V_{CC} = V_L = 5V$, $T_A = +25^\circ C$, unless otherwise noted.)

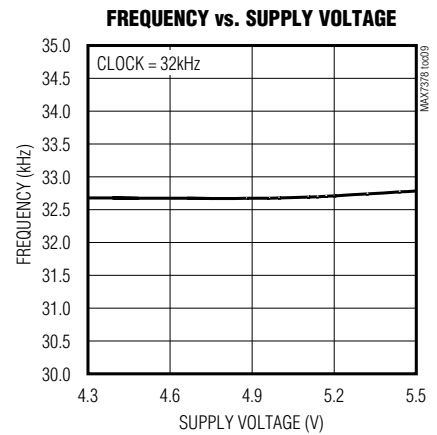
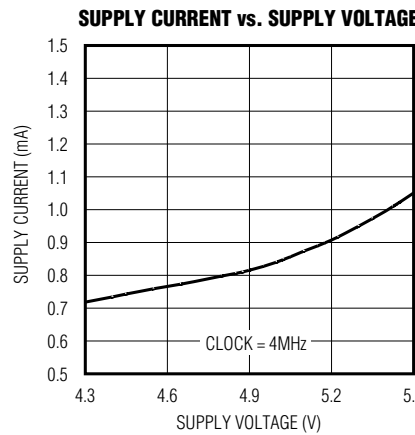
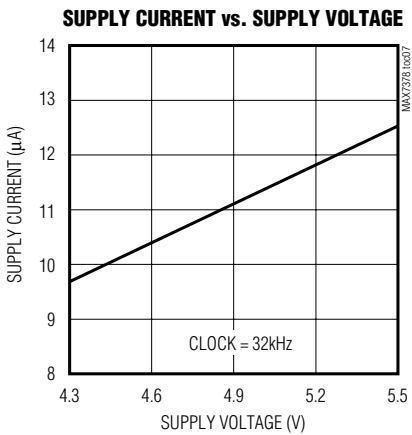
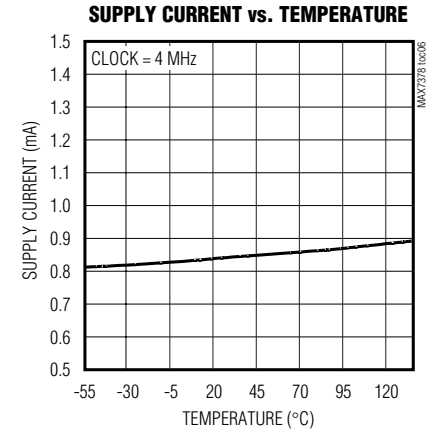
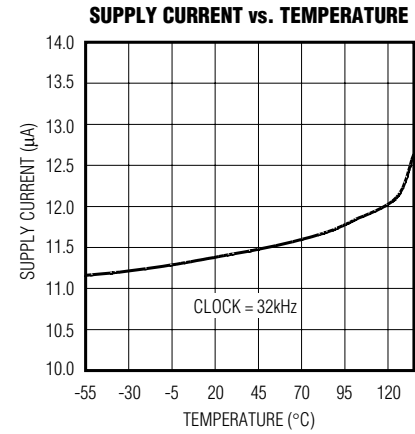
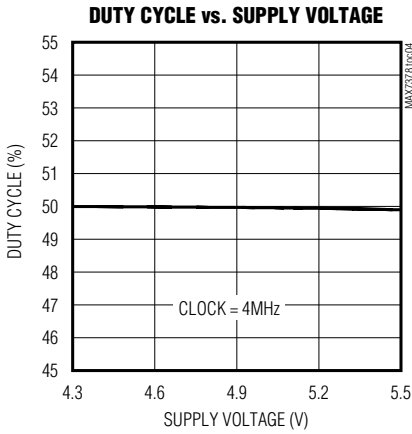
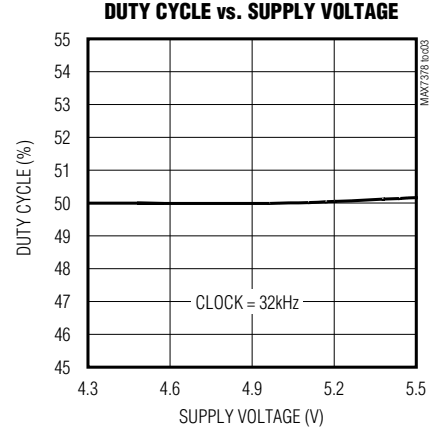
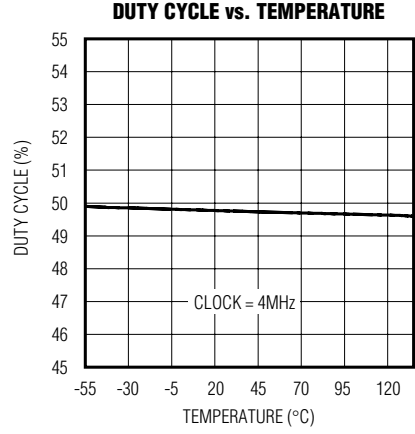
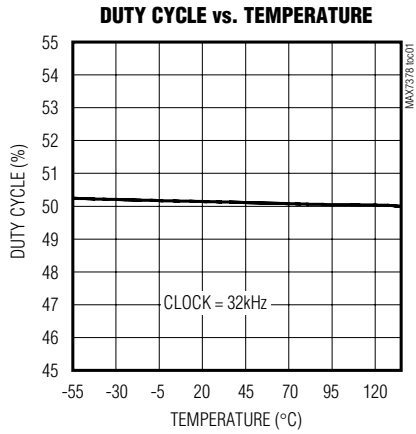

Silicon Oscillator with Low-Power Frequency Switching and Reset Output

Typical Operating Characteristics (continued)

($V_{CC} = V_L = 5V$, $T_A = +25^\circ C$, unless otherwise noted.)

MAX7378

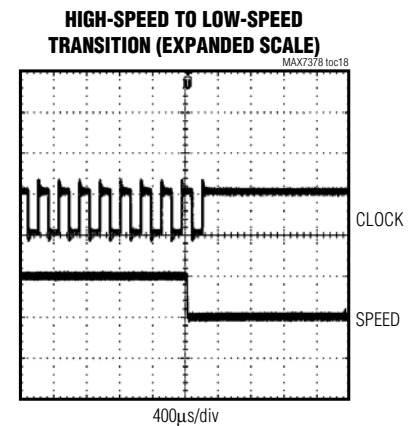
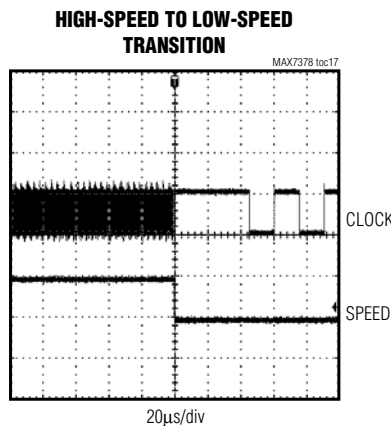
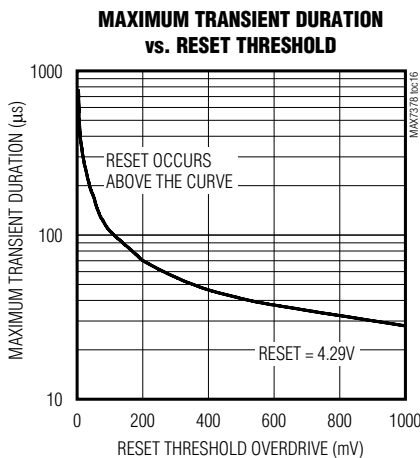
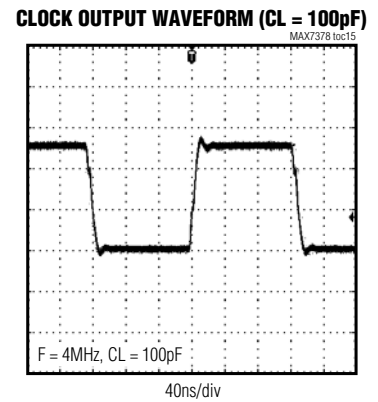
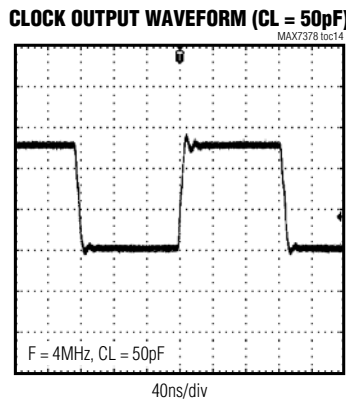
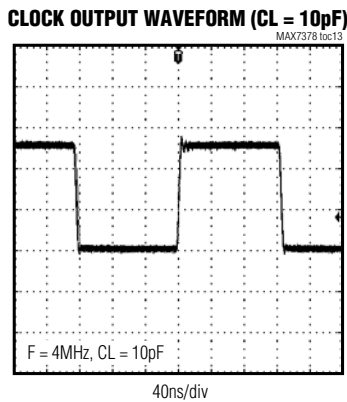
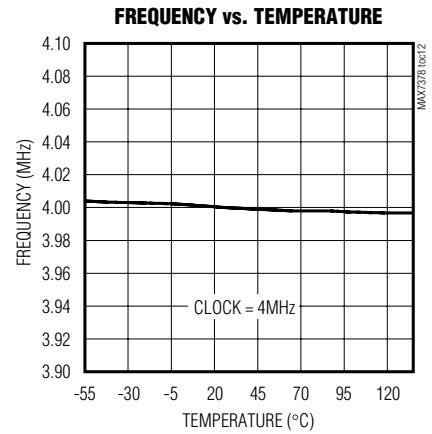
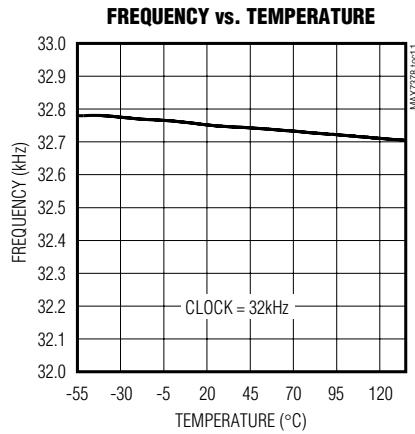
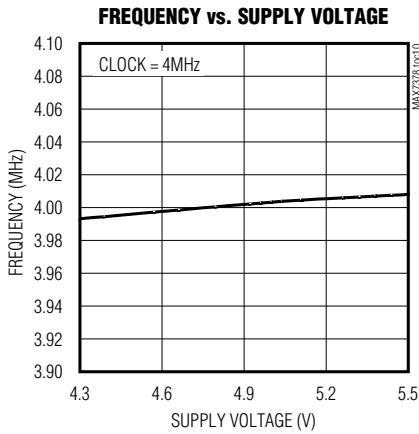

Silicon Oscillator with Low-Power Frequency Switching and Reset Output

Typical Operating Characteristics (continued)

($V_{CC} = V_L = 5V$, $T_A = +25^\circ\text{C}$, unless otherwise noted.)

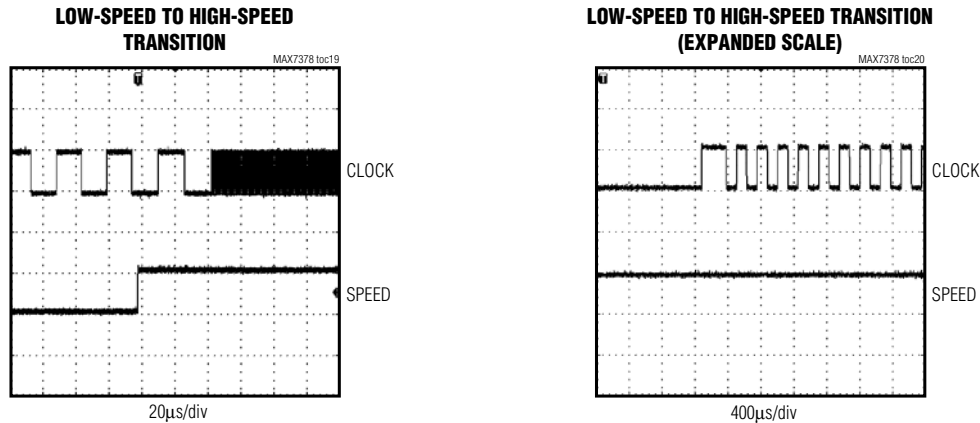

Pin Description

PIN	NAME	FUNCTION
1	V_{CC}	Positive Supply Voltage. Bypass V_{CC} to GND with a 0.1µF capacitor.
2	V_L	Output Supply Voltage. Connect V_L to V_{CC} . Bypass V_L to GND with a 0.1µF capacitor.
3	SPEED	Clock Speed-Select Input. Drive SPEED low to select the 32kHz fixed frequency. Drive SPEED high to select factory-trimmed frequency.
4	RST	Reset Output. See the RST <i>Reset Output Options</i> section for more details.
5	CLOCK	Push-Pull Clock Output
6	GND	Ground
7	ENABLE	Active-High Clock Enable Input. See the <i>ENABLE Input</i> section for more details.
8	N. C.	No Connect. No internal connection.

Detailed Description

The MAX7378 is a dual-speed clock generator with integrated reset for microcontrollers and UARTs in 3V, 3.3V, and 5V applications (Figure 1). The MAX7378 is a replacement for two crystal-oscillator modules, crystals, or ceramic resonators and a system-reset IC. The high-speed clock frequency is factory trimmed to specific values. A variety of popular standard frequencies are available (Table 2). The low-speed clock frequency is fixed at 32.768kHz (Figure 1). No external components are required for setting or adjusting the frequency.

Supply Voltage

The MAX7378 has been designed for use in systems with nominal supply voltages of 3V, 3.3V, or 5V and is specified for operation with supply voltages in the 2.7V to 5.5V range. See the *Absolute Maximum Ratings* section for limit values of power-supply and pin voltages.

Oscillator

The clock output is a push-pull configuration and is capable of driving a ground-connected 500Ω or a positive-supply connected 250Ω load to within 400mV of either supply rail. The clock output remains stable over the full operating voltage range and does not generate short output cycles when switching between high- and low-speed modes. A typical startup characteristic is shown in the *Typical Operating Characteristics*.

Silicon Oscillator with Low-Power Frequency Switching and Reset Output

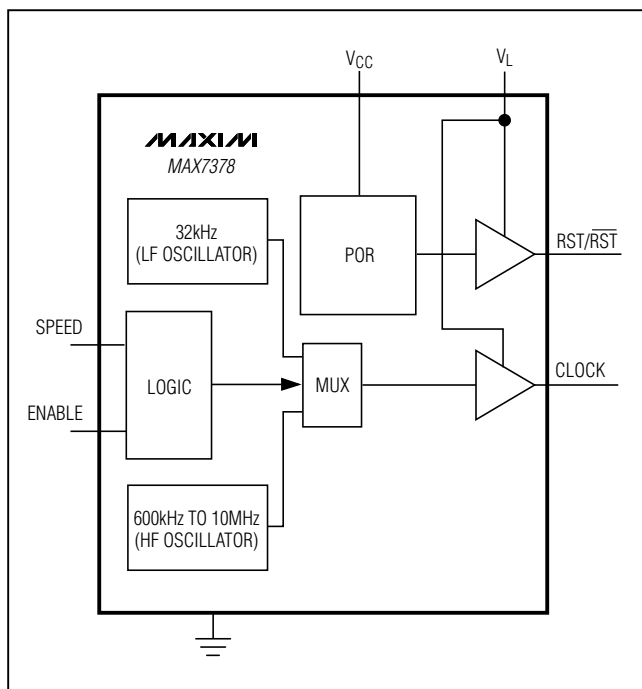

Figure 1. Functional Diagram

ENABLE Input

The MAX7378 has an active-high enable input that controls the clock and reset outputs. The clock output is driven high when disabled. The reset asserts when disabled (low for active-low reset, high for active-high reset). Drive ENABLE low to disable the clock output on the next rising edge. Drive ENABLE high to activate the clock output.

Clock-Speed Select Input

The MAX7378 uses logic input pin, SPEED, to set clock speed. Take this pin low to select slow clock speed (nominally 32.768kHz) or high to select full clock speed. The SPEED input may be strapped to VCC or to GND to select fast or slow clock speed, or connected to a logic output (such as a processor port) used to change clock speed on the fly. If the SPEED input is connected to a processor port that powers up in the input condition, connect a pullup or pulldown resistor to the SPEED input to set the clock to the preferred speed on power-up. The leakage current through the resistor into the SPEED input is very low, so a resistor value as high as 500k Ω may be used.

Applications Information

Interfacing to a Microcontroller Clock Input

The MAX7378 clock output is a push-pull, CMOS logic output that directly drives any μ P or μ C clock input. There are no impedance-matching issues when using the MAX7378. The MAX7378 is not sensitive to its position on the board and does not need to be placed right next to the μ P. Connect the MAX7378 V_L pin and μ C (or other clock-input device) to the same supply voltage level. Refer to the μ C data sheet for clock-input compatibility with external clock signals. The MAX7378 requires no biasing components or load capacitance. When using the MAX7378 to retrofit a crystal oscillator, remove all biasing components from the oscillator input.

RST Reset Output Options

The MAX7378 is available with three reset output stage options: push-pull with active-low output, push-pull with active-high output, and open drain with active-low output. The RST output is asserted when the monitored input (V_{CC}) drops below the internal V_{TH-} threshold and remains asserted for 100 μ s after the monitored input exceeds the internal V_{TH+} threshold. The open-drain RST output requires an external pullup resistor.

Output Jitter

The MAX7378's jitter performance is given in the *Electrical Characteristics* table as a peak-to-peak value obtained by observing the output of the MAX7378 for 20s with a 500MHz oscilloscope. Jitter values are approximately proportional to the period of the output frequency of the device. Thus, a 4MHz part has approximately twice the jitter value of an 8MHz part. The jitter performance of clock sources degrades in the presence of mechanical and electrical interference. The MAX7378 is relatively immune to vibration, shock, and EMI influences, and thus provides a considerably more robust clock source than crystal or ceramic resonator-based oscillator circuits.

Initial Power-Up and Operation

An initial power-up reset holds the reset output active for 100 μ s (typ). However, the clock starts up within 30 μ s (typ) at the frequency determined by the SPEED pin.

Power-Supply Brownout

The RST output is asserted whenever V_{CC} drops below the specified threshold level. The action of V_{CC} dropping below the reset threshold and then rising back above the threshold asserts RST and starts a normal

Silicon Oscillator with Low-Power Frequency Switching and Reset Output

power-on reset cycle. The MAX7378 reset circuit features internal hysteresis that creates two trip points: one for rising supply voltage and one for falling supply voltage. The standard threshold values (see Table 1) are the trip points for rising supply voltage. The trip point for falling supply voltage is calculated by subtracting the hysteresis value from the rising supply trip point. The hysteresis prevents the reset output from oscillating (chattering) when V_{CC} is near the voltage threshold. The reset circuit is immune to short transient V_{CC} drops (see Maximum Transient Duration vs. Reset Threshold in the *Typical Operating Characteristics*).

Extended Temperature Operation

The MAX7378 was tested to +135°C during product characterization and shown to function normally at this temperature (see the *Typical Operating Characteristics*). However, production test and qualification is only performed from -40°C to +125°C at this time. Contact the factory if operation outside this range is required.

Table 1. Standard Reset Threshold Levels

SUFFIX	RESET THRESHOLD (V)
R	2.57
M	4.29

For all other reset threshold options, contact the factory.

Table 2. Standard Frequencies

SUFFIX	STANDARD FREQUENCY (MHz)
MG	1
OK	1.8432
QT	3.39545
QW	3.6864
RD	4
RH	4.1943
TP	8

For all other frequency options, contact the factory.

Power-Supply Considerations

The MAX7378 operates with a 2.7V and 5.5V power-supply voltage. There are two power-supply pins, V_{CC} and V_L . V_{CC} provides the main power input to the device and V_L supplies the clock and reset output circuits. Good power-supply decoupling is needed to maintain the power-supply rejection performance of the MAX7378. Bypass both V_{CC} and V_L to GND with a 0.1 μ F surface-mount ceramic capacitor. Mount the bypassing capacitors as close to the device as possible. If possible, mount the MAX7378 close to the μ C's decoupling capacitor so that additional decoupling is not required. A larger value bypass capacitor is recommended if the MAX7378 is to operate with a large capacitive load. Use a bypass capacitor value of at least 1000 times that of the output load capacitance.

Note: V_L must be equal to V_{CC} .

Pin Configuration

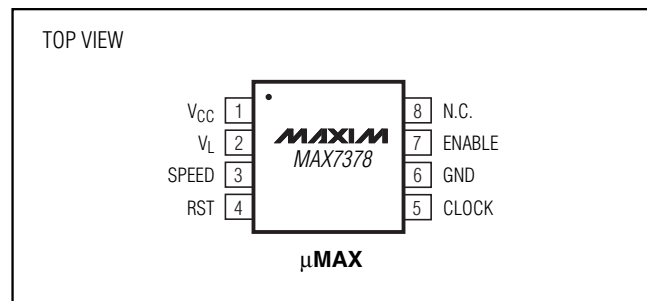

Silicon Oscillator with Low-Power Frequency Switching and Reset Output

MAX7378

Table 3. Standard Part Numbers

PART	PIN-PACKAGE	RESET OUTPUT TYPE	RESET THRESHOLD (V)	FREQUENCY (MHZ)
MAX7378CRMG	8 μ MAX	Open drain	2.57	1
MAX7378CROK	8 μ MAX	Open drain	2.57	1.8432
MAX7378CRQT	8 μ MAX	Open drain	2.57	3.39545
MAX7378CRQW	8 μ MAX	Open drain	2.57	3.6864
MAX7378CRRD	8 μ MAX	Open drain	2.57	4
MAX7378CRRH	8 μ MAX	Open drain	2.57	4.1943
MAX7378CRTP	8 μ MAX	Open drain	2.57	8
MAX7378CMMG	8 μ MAX	Open drain	4.29	1
MAX7378CMOK	8 μ MAX	Open drain	4.29	1.8432
MAX7378CMQT	8 μ MAX	Open drain	4.29	3.39545
MAX7378CMQW	8 μ MAX	Open drain	4.29	3.6864
MAX7378CMRD	8 μ MAX	Open drain	4.29	4
MAX7378CMRH	8 μ MAX	Open drain	4.29	4.1943
MAX7378CMTP	8 μ MAX	Open drain	4.29	8

Chip Information

TRANSISTOR COUNT: 2027

PROCESS: BiCMOS

Silicon Oscillator with Low-Power Frequency Switching and Reset Output

Package Information

(The package drawing(s) in this data sheet may not reflect the most current specifications. For the latest package outline information go to www.maxim-ic.com/packages.)

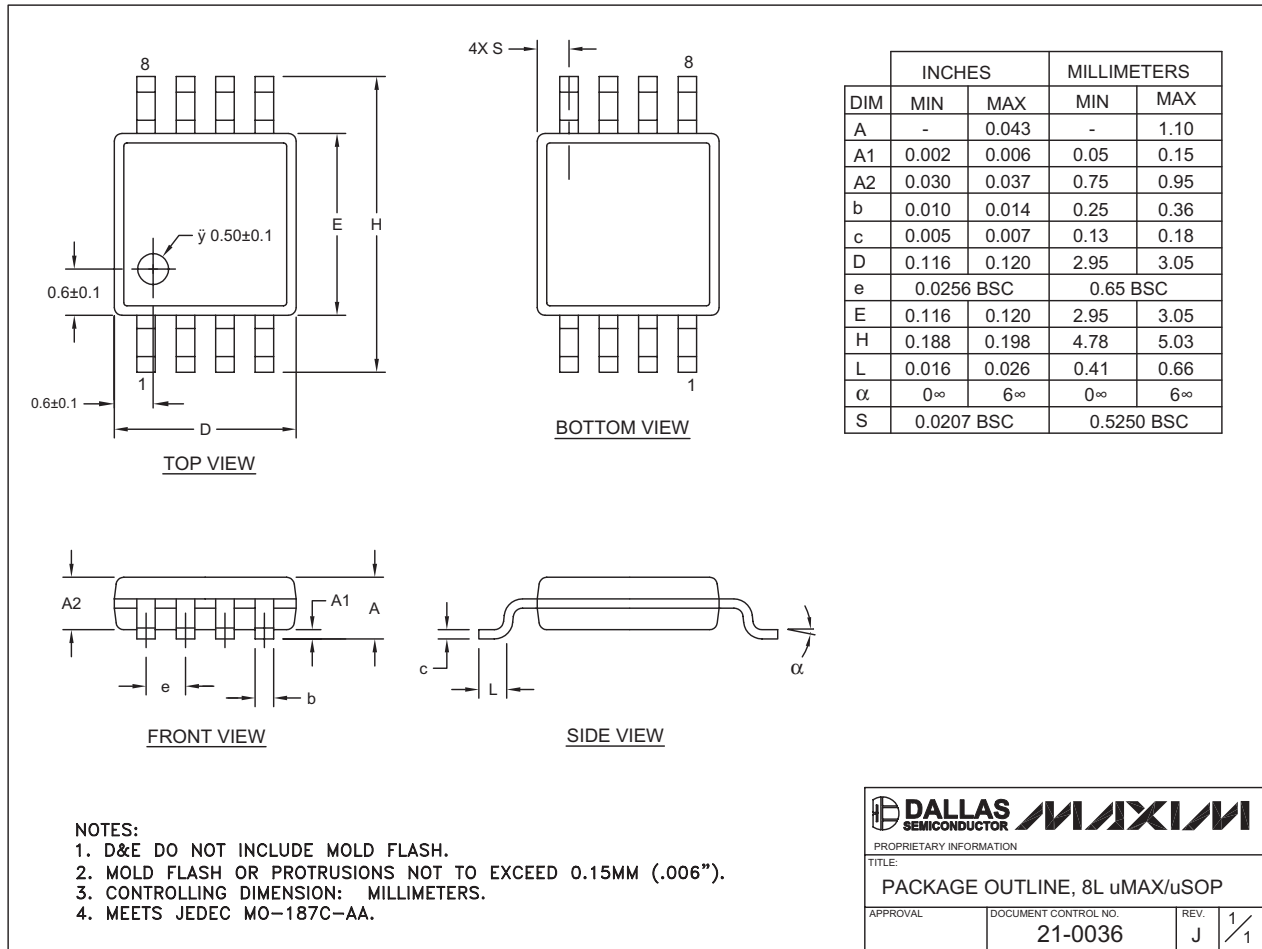

8LUMAXD.EPS

Maxim cannot assume responsibility for use of any circuitry other than circuitry entirely embodied in a Maxim product. No circuit patent licenses are implied. Maxim reserves the right to change the circuitry and specifications without notice at any time.