

Low-Voltage CMOS Quad 2-Input OR Gate With 5V-Tolerant Inputs

The MC74LCX32 is a high performance, quad 2-input OR gate operating from a 2.7 to 3.6V supply. High impedance TTL compatible inputs significantly reduce current loading to input drivers while TTL compatible outputs offer improved switching noise performance. A V_I specification of 5.5V allows MC74LCX32 inputs to be safely driven from 5V devices.

Current drive capability is 24mA at the outputs.

- Designed for 2.7 to 3.6V V_{CC} Operation
- 5V Tolerant Inputs — Interface Capability With 5V TTL Logic
- LVTTTL Compatible
- LVCMOS Compatible
- 24mA Balanced Output Sink and Source Capability
- Near Zero Static Supply Current (10 μ A) Substantially Reduces System Power Requirements
- Latchup Performance Exceeds 500mA
- ESD Performance: Human Body Model >2000V; Machine Model >200V

Pinout: 14-Lead (Top View)

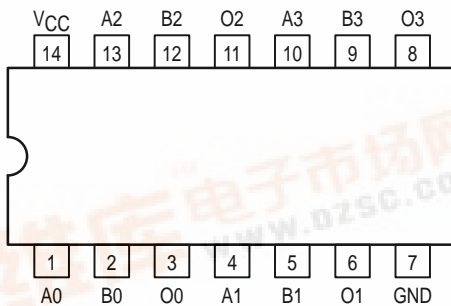

LOGIC DIAGRAM

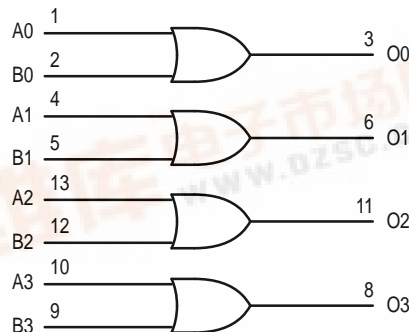

MC74LCX32

LCX

LOW-VOLTAGE CMOS QUAD 2-INPUT OR GATE

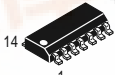

D SUFFIX
PLASTIC SOIC
CASE 751A-03

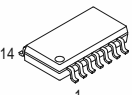

M SUFFIX
PLASTIC SOIC EIAJ
CASE 965-01



SD SUFFIX
PLASTIC SSOP
CASE 940A-03



DT SUFFIX
PLASTIC TSSOP
CASE 948G-01

PIN NAMES

Pins	Function
An, Bn	Data Inputs
On	Outputs

FUNCTION TABLE

INPUTS		OUTPUTS
An	Bn	On
L	L	L
L	H	H
H	L	H
H	H	H

MC74LCX32

ABSOLUTE MAXIMUM RATINGS*

Symbol	Parameter	Value	Condition	Unit
V _{CC}	DC Supply Voltage	-0.5 to +7.0		V
V _I	DC Input Voltage	-0.5 ≤ V _I ≤ +7.0		V
V _O	DC Output Voltage	-0.5 ≤ V _O ≤ V _{CC} + 0.5	Note 1.	V
I _{IK}	DC Input Diode Current	-50	V _I < GND	mA
I _{OK}	DC Output Diode Current	-50	V _O < GND	mA
		+50	V _O > V _{CC}	mA
I _O	DC Output Source/Sink Current	±50		mA
I _{CC}	DC Supply Current Per Supply Pin	±100		mA
I _{GND}	DC Ground Current Per Ground Pin	±100		mA
T _{STG}	Storage Temperature Range	-65 to +150		°C

* Absolute maximum continuous ratings are those values beyond which damage to the device may occur. Exposure to these conditions or conditions beyond those indicated may adversely affect device reliability. Functional operation under absolute-maximum-rated conditions is not implied.

1. Output in HIGH or LOW State. I_O absolute maximum rating must be observed.

RECOMMENDED OPERATING CONDITIONS

Symbol	Parameter	Min	Typ	Max	Unit	
V _{CC}	Supply Voltage	Operating	2.0	3.3	3.6	V
		Data Retention Only	1.5	3.3	3.6	
V _I	Input Voltage	0		5.5	V	
V _O	Output Voltage (HIGH or LOW State)	0		V _{CC}	V	
I _{OH}	HIGH Level Output Current, V _{CC} = 3.0V – 3.6V			-24	mA	
I _{OL}	LOW Level Output Current, V _{CC} = 3.0V – 3.6V			24	mA	
I _{OH}	HIGH Level Output Current, V _{CC} = 2.7V – 3.0V			-12	mA	
I _{OL}	LOW Level Output Current, V _{CC} = 2.7V – 3.0V			12	mA	
T _A	Operating Free-Air Temperature	-40		+85	°C	
Δt/ΔV	Input Transition Rise or Fall Rate, V _{IIN} from 0.8V to 2.0V, V _{CC} = 3.0V	0		10	ns/V	

DC ELECTRICAL CHARACTERISTICS

Symbol	Characteristic	Condition	T _A = -40°C to +85°C		Unit
			Min	Max	
V _{IH}	HIGH Level Input Voltage (Note 2.)	2.7V ≤ V _{CC} ≤ 3.6V	2.0		V
V _{IL}	LOW Level Input Voltage (Note 2.)	2.7V ≤ V _{CC} ≤ 3.6V		0.8	V
V _{OH}	HIGH Level Output Voltage	2.7V ≤ V _{CC} ≤ 3.6V; I _{OH} = -100μA	V _{CC} - 0.2		V
		V _{CC} = 2.7V; I _{OH} = -12mA	2.2		
		V _{CC} = 3.0V; I _{OH} = -18mA	2.4		
		V _{CC} = 3.0V; I _{OH} = -24mA	2.2		
V _{OL}	LOW Level Output Voltage	2.7V ≤ V _{CC} ≤ 3.6V; I _{OL} = 100μA		0.2	V
		V _{CC} = 2.7V; I _{OL} = 12mA		0.4	
		V _{CC} = 3.0V; I _{OL} = 16mA		0.4	
		V _{CC} = 3.0V; I _{OL} = 24mA		0.55	

2. These values of V_I are used to test DC electrical characteristics only.

DC ELECTRICAL CHARACTERISTICS (continued)

Symbol	Characteristic	Condition	$T_A = -40^\circ\text{C}$ to $+85^\circ\text{C}$		Unit
			Min	Max	
I_I	Input Leakage Current	$2.7\text{V} \leq V_{CC} \leq 3.6\text{V}; 0\text{V} \leq V_I \leq 5.5\text{V}$		± 5.0	μA
I_{CC}	Quiescent Supply Current	$2.7 \leq V_{CC} \leq 3.6\text{V}; V_I = \text{GND or } V_{CC}$		10	μA
		$2.7 \leq V_{CC} \leq 3.6\text{V}; 3.6 \leq V_I \leq 5.5\text{V}$		± 10	μA
ΔI_{CC}	Increase in I_{CC} per Input	$2.7 \leq V_{CC} \leq 3.6\text{V}; V_{IH} = V_{CC} - 0.6\text{V}$		500	μA

AC CHARACTERISTICS ($t_R = t_F = 2.5\text{ns}$; $C_L = 50\text{pF}$; $R_L = 500\Omega$)

Symbol	Parameter	Waveform	Limits			Unit
			$T_A = -40^\circ\text{C}$ to $+85^\circ\text{C}$			
			$V_{CC} = 3.0\text{V}$ to 3.6V		$V_{CC} = 2.7\text{V}$	
			Min	Max	Max	
t_{PLH} t_{PHL}	Propagation Delay Input to Output	1	1.5 1.5	5.5 5.5	6.2 6.2	ns
t_{OSHL} t_{OSLH}	Output-to-Output Skew (Note 3.)			1.0 1.0		ns

3. Skew is defined as the absolute value of the difference between the actual propagation delay for any two separate outputs of the same device. The specification applies to any outputs switching in the same direction, either HIGH-to-LOW (t_{OSHL}) or LOW-to-HIGH (t_{OSLH}); parameter guaranteed by design.

DYNAMIC SWITCHING CHARACTERISTICS

Symbol	Characteristic	Condition	$T_A = +25^\circ\text{C}$			Unit
			Min	Typ	Max	
V_{OLP}	Dynamic LOW Peak Voltage (Note 4.)	$V_{CC} = 3.3\text{V}, C_L = 50\text{pF}, V_{IH} = 3.3\text{V}, V_{IL} = 0\text{V}$		0.8		V
V_{OLV}	Dynamic LOW Valley Voltage (Note 4.)	$V_{CC} = 3.3\text{V}, C_L = 50\text{pF}, V_{IH} = 3.3\text{V}, V_{IL} = 0\text{V}$		0.8		V

4. Number of outputs defined as "n". Measured with "n-1" outputs switching from HIGH-to-LOW or LOW-to-HIGH. The remaining output is measured in the LOW state.

CAPACITIVE CHARACTERISTICS

Symbol	Parameter	Condition	Typical	Unit
C_{IN}	Input Capacitance	$V_{CC} = 3.3\text{V}, V_I = 0\text{V or } V_{CC}$	7	pF
C_{OUT}	Output Capacitance	$V_{CC} = 3.3\text{V}, V_I = 0\text{V or } V_{CC}$	8	pF
CPD	Power Dissipation Capacitance	10MHz, $V_{CC} = 3.3\text{V}, V_I = 0\text{V or } V_{CC}$	25	pF

MC74LCX32

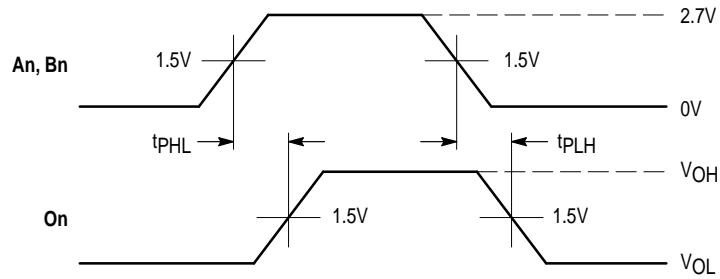

PROPAGATION DELAYS
 $t_R = t_F = 2.5\text{ns}$, 10% to 90%; $f = 1\text{MHz}$; $t_W = 500\text{ns}$

Figure 1. AC Waveforms

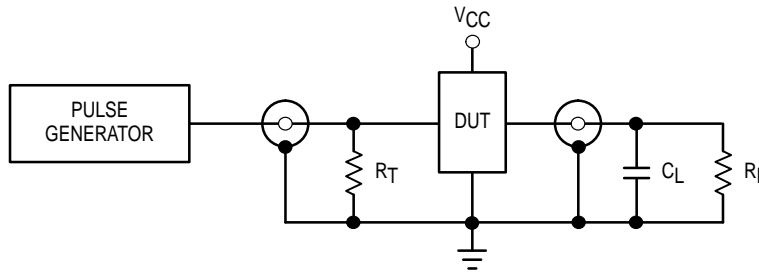

$C_L = 50\text{pF}$ or equivalent (Includes jig and probe capacitance)
 $R_L = R_1 = 500\Omega$ or equivalent
 $R_T = Z_{OUT}$ of pulse generator (typically 50Ω)

Figure 2. Test Circuit

OUTLINE DIMENSIONS

D SUFFIX
 PLASTIC SOIC PACKAGE
 CASE 751A-03
 ISSUE F

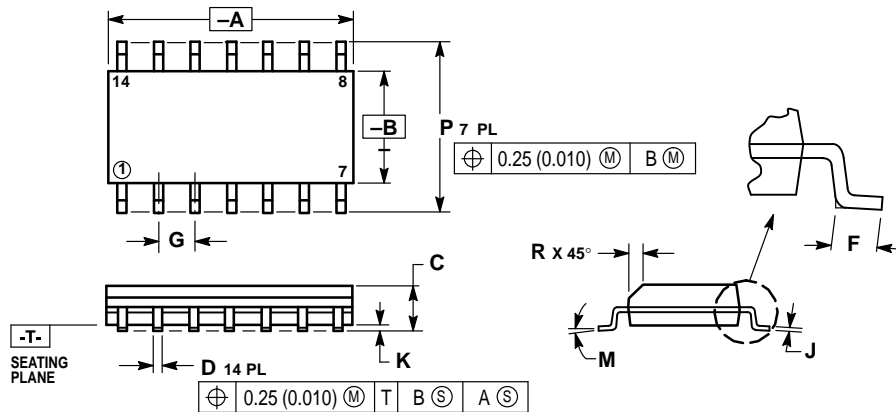

- NOTES:
1. DIMENSIONING AND TOLERANCING PER ANSI Y14.5M, 1982.
 2. CONTROLLING DIMENSION: MILLIMETER.
 3. DIMENSIONS A AND B DO NOT INCLUDE MOLD PROTRUSION.
 4. MAXIMUM MOLD PROTRUSION 0.15 (0.006) PER SIDE.
 5. DIMENSION D DOES NOT INCLUDE DAMBAR PROTRUSION. ALLOWABLE DAMBAR PROTRUSION SHALL BE 0.127 (0.005) TOTAL IN EXCESS OF THE D DIMENSION AT MAXIMUM MATERIAL CONDITION.

DIM	MILLIMETERS		INCHES	
	MIN	MAX	MIN	MAX
A	8.55	8.75	0.337	0.344
B	3.80	4.00	0.150	0.157
C	1.35	1.75	0.054	0.068
D	0.35	0.49	0.014	0.019
F	0.40	1.25	0.016	0.049
G	1.27 BSC		0.050 BSC	
J	0.19	0.25	0.008	0.009
K	0.10	0.25	0.004	0.009
M	0°	7°	0°	7°
P	5.80	6.20	0.228	0.244
R	0.25	0.50	0.010	0.019

M SUFFIX
 PLASTIC SOIC EIAJ PACKAGE
 CASE 965-01
 ISSUE O

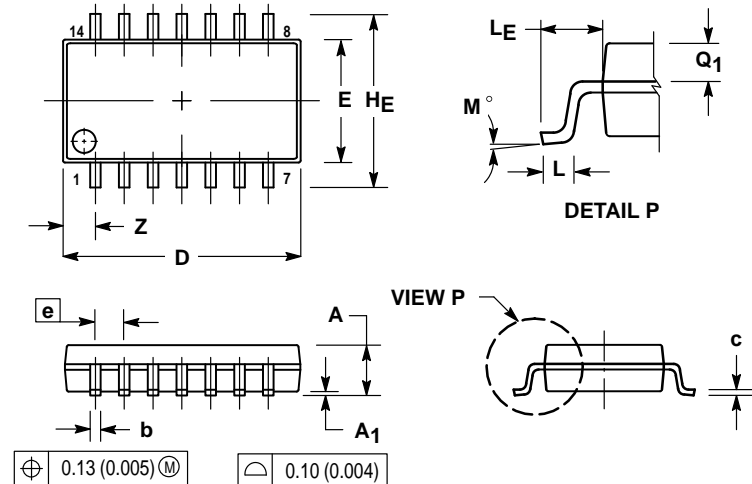

- NOTES:
1. DIMENSIONING AND TOLERANCING PER ANSI Y14.5M, 1982.
 2. CONTROLLING DIMENSION: MILLIMETER.
 3. DIMENSIONS D AND E DO NOT INCLUDE MOLD FLASH OR PROTRUSIONS AND ARE MEASURED AT THE PARTING LINE. MOLD FLASH OR PROTRUSIONS SHALL NOT EXCEED 0.15 (0.006) PER SIDE.
 4. TERMINAL NUMBERS ARE SHOWN FOR REFERENCE ONLY.
 5. THE LEAD WIDTH DIMENSION (b) DOES NOT INCLUDE DAMBAR PROTRUSION. ALLOWABLE DAMBAR PROTRUSION SHALL BE 0.08 (0.003) TOTAL IN EXCESS OF THE LEAD WIDTH DIMENSION AT MAXIMUM MATERIAL CONDITION. DAMBAR CANNOT BE LOCATED ON THE LOWER RADIUS OR THE FOOT. MINIMUM SPACE BETWEEN PROTRUSIONS AND ADJACENT LEAD TO BE 0.46 (0.018).

DIM	MILLIMETERS		INCHES	
	MIN	MAX	MIN	MAX
A	---	2.05	---	0.081
A1	0.05	0.20	0.002	0.008
b	0.35	0.50	0.014	0.020
c	0.18	0.27	0.007	0.011
D	9.90	10.50	0.390	0.413
E	5.10	5.45	0.201	0.215
e	1.27 BSC		0.050 BSC	
HE	7.40	8.20	0.291	0.323
L	0.50	0.85	0.020	0.033
LE	1.10	1.50	0.043	0.059
M	0°	10°	0°	10°
Q1	0.70	0.90	0.028	0.035
Z	---	1.42	---	0.056

OUTLINE DIMENSIONS

SD SUFFIX
PLASTIC SSOP PACKAGE
CASE 940A-03
ISSUE B

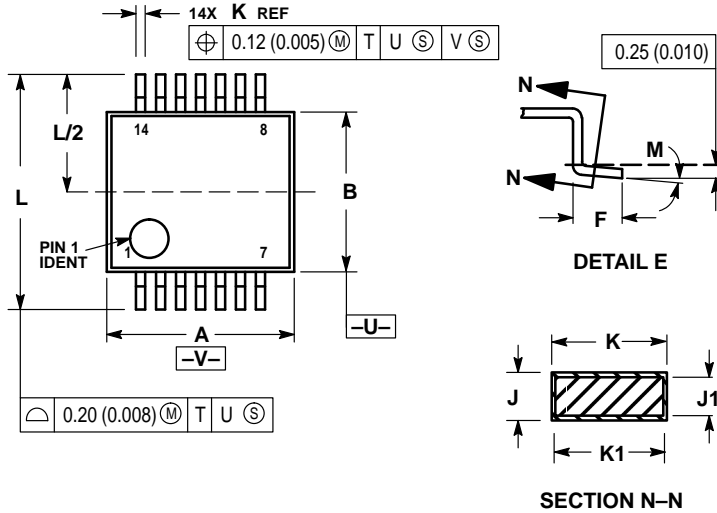

- NOTES:
- DIMENSIONING AND TOLERANCING PER ANSI Y14.5M, 1982.
 - CONTROLLING DIMENSION: MILLIMETER.
 - DIMENSION A DOES NOT INCLUDE MOLD FLASH, PROTRUSIONS OR GATE BURRS. MOLD FLASH OR GATE BURRS SHALL NOT EXCEED 0.15 (0.006) PER SIDE.
 - DIMENSION B DOES NOT INCLUDE INTERLEAD FLASH OR PROTRUSION. INTERLEAD FLASH OR PROTRUSION SHALL NOT EXCEED 0.15 (0.006) PER SIDE.
 - DIMENSION K DOES NOT INCLUDE DAMBAR PROTRUSION/INTRUSION. ALLOWABLE DAMBAR PROTRUSION SHALL BE 0.13 (0.005) TOTAL IN EXCESS OF K DIMENSION AT MAXIMUM MATERIAL CONDITION. DAMBAR INTRUSION SHALL NOT REDUCE DIMENSION K BY MORE THAN 0.07 (0.002) AT LEAST MATERIAL CONDITION.
 - TERMINAL NUMBERS ARE SHOWN FOR REFERENCE ONLY.
 - DIMENSION A AND B ARE TO BE DETERMINED AT DATUM PLANE -W-.

DIM	MILLIMETERS		INCHES	
	MIN	MAX	MIN	MAX
A	6.07	6.33	0.238	0.249
B	5.20	5.38	0.205	0.212
C	1.73	1.99	0.068	0.078
D	0.05	0.21	0.002	0.008
F	0.63	0.95	0.024	0.037
G	0.65 BSC		0.026 BSC	
H	1.08	1.22	0.042	0.048
J	0.09	0.20	0.003	0.008
J1	0.09	0.16	0.003	0.006
K	0.25	0.38	0.010	0.015
K1	0.25	0.33	0.010	0.013
L	7.65	7.90	0.301	0.311
M	0°	8°	0°	8°

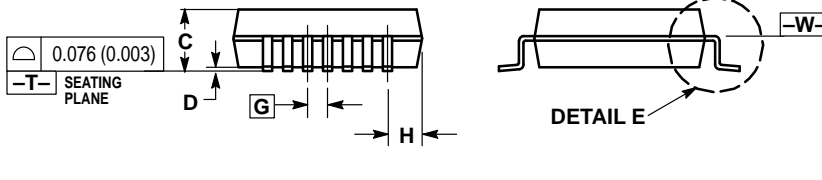

DT SUFFIX
PLASTIC TSSOP PACKAGE
CASE 948G-01
ISSUE O

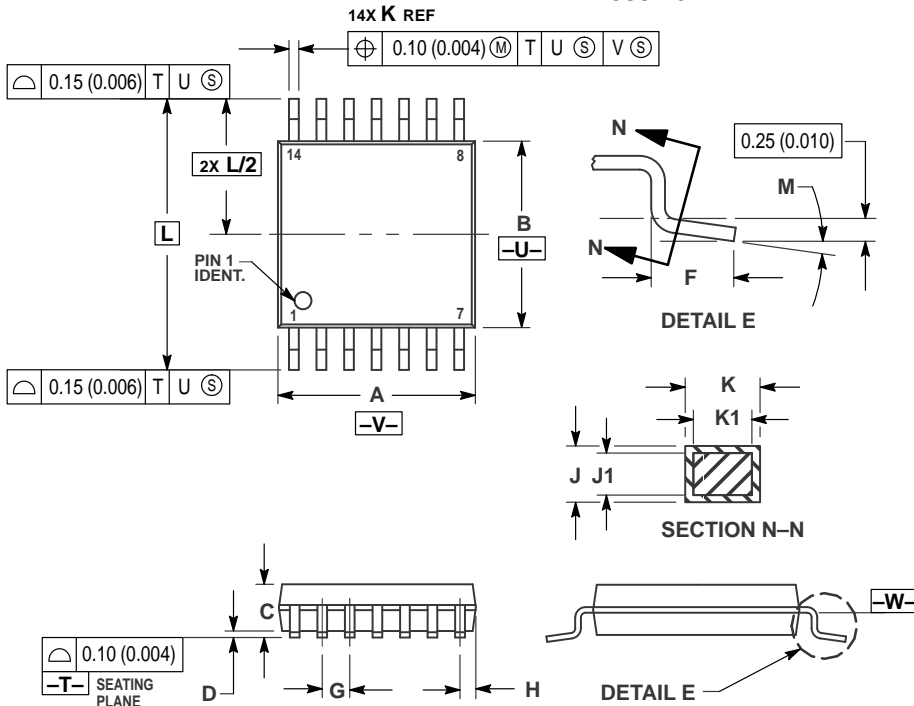

- NOTES:
- DIMENSIONING AND TOLERANCING PER ANSI Y14.5M, 1982.
 - CONTROLLING DIMENSION: MILLIMETER.
 - DIMENSION A DOES NOT INCLUDE MOLD FLASH, PROTRUSIONS OR GATE BURRS. MOLD FLASH OR GATE BURRS SHALL NOT EXCEED 0.15 (0.006) PER SIDE.
 - DIMENSION B DOES NOT INCLUDE INTERLEAD FLASH OR PROTRUSION. INTERLEAD FLASH OR PROTRUSION SHALL NOT EXCEED 0.25 (0.010) PER SIDE.
 - DIMENSION K DOES NOT INCLUDE DAMBAR PROTRUSION. ALLOWABLE DAMBAR PROTRUSION SHALL BE 0.08 (0.003) TOTAL IN EXCESS OF THE K DIMENSION AT MAXIMUM MATERIAL CONDITION.
 - TERMINAL NUMBERS ARE SHOWN FOR REFERENCE ONLY.
 - DIMENSION A AND B ARE TO BE DETERMINED AT DATUM PLANE -W-.

DIM	MILLIMETERS		INCHES	
	MIN	MAX	MIN	MAX
A	4.90	5.10	0.193	0.200
B	4.30	4.50	0.169	0.177
C	—	1.20	—	0.047
D	0.05	0.15	0.002	0.006
F	0.50	0.75	0.020	0.030
G	0.65 BSC		0.026 BSC	
H	0.50	0.60	0.020	0.024
J	0.09	0.20	0.004	0.008
J1	0.09	0.16	0.004	0.006
K	0.19	0.30	0.007	0.012
K1	0.19	0.25	0.007	0.010
L	6.40 BSC		0.252 BSC	
M	0°	8°	0°	8°

Motorola reserves the right to make changes without further notice to any products herein. Motorola makes no warranty, representation or guarantee regarding the suitability of its products for any particular purpose, nor does Motorola assume any liability arising out of the application or use of any product or circuit, and specifically disclaims any and all liability, including without limitation consequential or incidental damages. "Typical" parameters which may be provided in Motorola data sheets and/or specifications can and do vary in different applications and actual performance may vary over time. All operating parameters, including "Typicals" must be validated for each customer application by customer's technical experts. Motorola does not convey any license under its patent rights nor the rights of others. Motorola products are not designed, intended, or authorized for use as components in systems intended for surgical implant into the body, or other applications intended to support or sustain life, or for any other application in which the failure of the Motorola product could create a situation where personal injury or death may occur. Should Buyer purchase or use Motorola products for any such unintended or unauthorized application, Buyer shall indemnify and hold Motorola and its officers, employees, subsidiaries, affiliates, and distributors harmless against all claims, costs, damages, and expenses, and reasonable attorney fees arising out of, directly or indirectly, any claim of personal injury or death associated with such unintended or unauthorized use, even if such claim alleges that Motorola was negligent regarding the design or manufacture of the part. Motorola and  are registered trademarks of Motorola, Inc. Motorola, Inc. is an Equal Opportunity/Affirmative Action Employer.

How to reach us:

USA/EUROPE/Locations Not Listed: Motorola Literature Distribution;
P.O. Box 5405; Denver, Colorado 80217. 1-800-441-2447

MFAX: RMFAX0@email.sps.mot.com – TOUCHTONE 602-244-6609
INTERNET: <http://Design-NET.com>

JAPAN: Nippon Motorola Ltd.; Tatsumi-SPD-JLDC, 6F Seibu-Butsuryu-Center,
3-14-2 Tatsumi Koto-Ku, Tokyo 135, Japan. 81-3-3521-8315

ASIA/PACIFIC: Motorola Semiconductors H.K. Ltd.; 8B Tai Ping Industrial Park,
51 Ting Kok Road, Tai Po, N.T., Hong Kong. 852-26629298