

**SONY**

**CXD1916R**

**Digital Video Encoder**

**Description**

The CXD1916R is a digital video encoder designed for Video CDs, car navigation and other digital video equipment. This device accepts ITU-R601 format Y, Cb and Cr data and ITU-R656 format Y, Cb and Cr data, and the data are encoded to composite video and separate Y/C video (S-video) signals and converted to RGB/YUV signals.

**Features**

- NTSC, PAL, MPAL and 4.43NTSC encoding modes
- Composite video and separate Y/C video (S-video) signal output
- R, G, B/Y, U, V (BetaCam/SMPTE level) signal output
- 8/16-bit pixel data input modes
- 13.5Mpps pixel rate
- 12.27 and 14.75Mpps square pixel rates
- External synchronization using HSYNC, VSYNC and FID inputs, or internal synchronization
- Supports interlace and non-interlace modes
- On-chip 100% color bar generator
- OSD function
- ITU-R656 code signal EAV decoding
- Supports I<sup>2</sup>C bus (400kHz) and Sony SIO
- Closed Caption (line 21, line 284) encoding
- VBID encoding
- WSS encoding
- 10-bit 3-channel DAC
- Monolithic CMOS single 3.3V power supply
- 80-pin plastic LQFP

80 pin LQFP (Plastic)

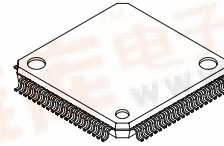

**Absolute Maximum Ratings**

- Supply voltage  $V_{DD}$   $V_{SS} - 0.5$  to  $+4.6$  V
- Input voltage  $V_I$   $V_{SS} - 0.5$  to  $+7.0$  V
- Output voltage  $V_O$   $V_{SS} - 0.5$  to  $V_{DD} + 0.5$  V
- Operating temperature
 

$T_{opr}$	-20 to +75	°C
-----------	------------	----
- Storage temperature
 

$T_{stg}$	-55 to +150	°C
-----------	-------------	----

 ( $V_{SS} = 0V$ )

**Recommended Operating Conditions**

- Supply voltage  $V_{DD}$   $3.3 \pm 0.3$  V
- Input voltage  $V_{IN}$   $V_{SS}$  to  $5.5$  V
- Operating temperature
 

$T_{opr}$	0 to +70	°C
-----------	----------	----

**I/O Capacitance**

- Input capacitance  $C_i$  9 (Max.) pF
- Output capacitance  $C_o$  11 (Max.) pF

**Note)** Test conditions:  $V_{DD} = V_I = 0V$ ,  $f_m = 1MHz$

Sony reserves the right to change products and specifications without prior notice. This information does not convey any license by any implication or otherwise under any patents or other right. Application circuits shown, if any, are typical examples illustrating the operation of the devices. Sony cannot assume responsibility for any problems arising out of the use of these circuits.



Block Diagram

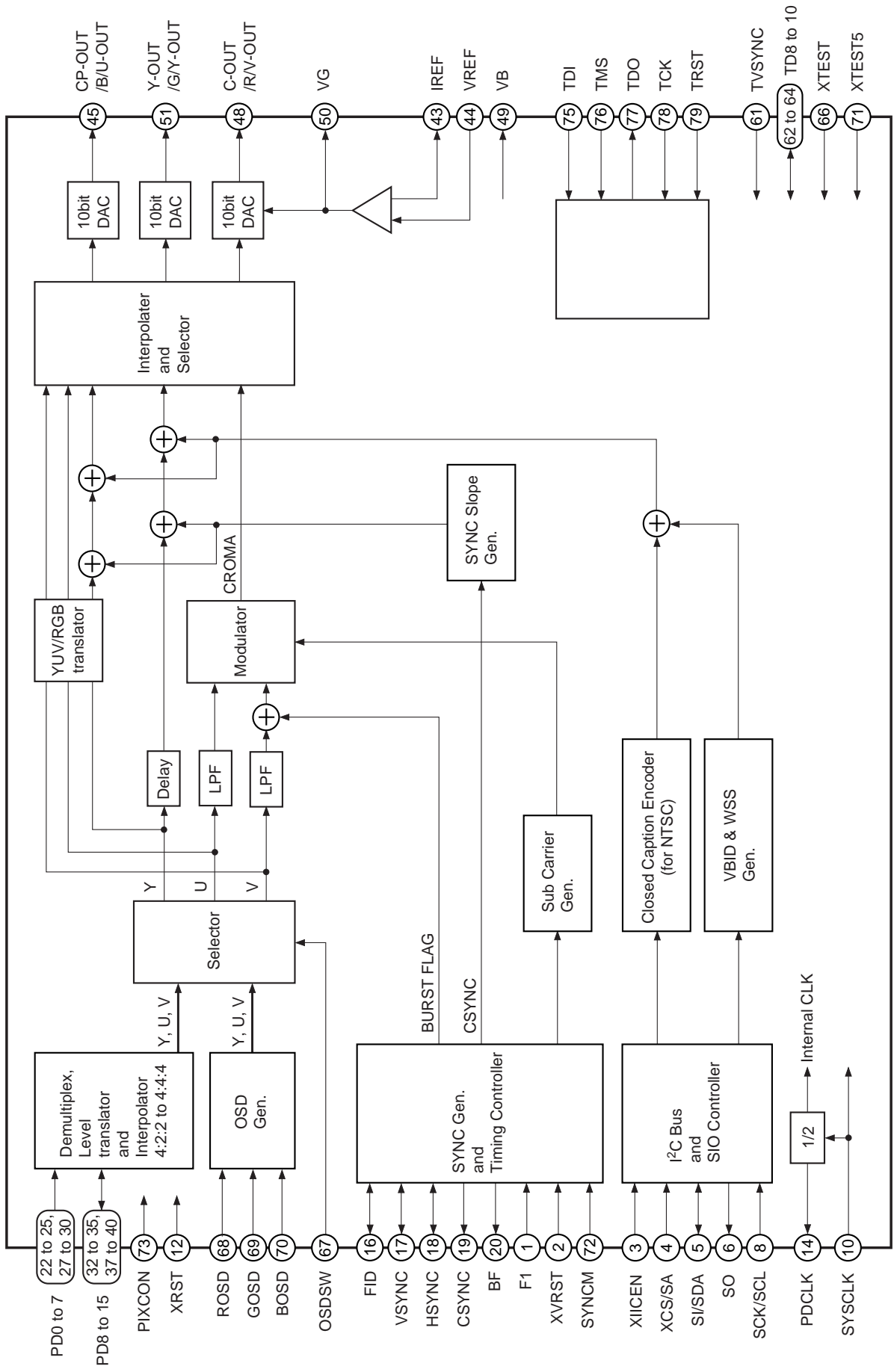

## Pin Description

Pin No.	Symbol	I/O	Description
1	F1	I	Field ID input. This signal indicates the field ID when resetting the vertical sync. High indicates 1st field. Low indicates 2nd field.
2	XVRST	I	Vertical sync reset input in active Low. This pin is pulled up. This is used for synchronizing the phases of the external and internal vertical sync signals. When XVRST = Low, the internal digital sync generator is reset according to the F1 status.
3	XIICEN	I	Serial interface mode select input. This pin is pulled up. When XIICEN = Low, Pins 4, 5, 6 and 8 are I <sup>2</sup> C bus mode. When XIICEN = High, Pins 4, 5, 6 and 8 are Sony SIO mode.
4	XCS/SA	I	This pin's function is selected by XIICEN (Pin 3). This pin is pulled up. When XIICEN = High, this pin is Sony SIO mode; XCS chip select input. When XIICEN = Low, this pin is I <sup>2</sup> C bus mode; SA slave address select input signal which selects the I <sup>2</sup> C bus slave address.
5	SI/SDA	I/O	This pin's function is selected by XIICEN (Pin 3). When XIICEN = High, this pin is Sony SIO mode; SI serial data input. When XIICEN = Low, this pin is I <sup>2</sup> C bus mode; SDA input/output.
6	SO	O	This pin's function is selected by XIICEN (Pin 3). When XIICEN = High, this pin is Sony SIO mode; SO serial output. When XIICEN = Low, this pin is not used and output is high impedance.
7	Vss1	—	Digital ground.
8	SCK/SCL	I	This pin's function is selected by XIICEN (Pin 3). When XIICEN = High, this pin is Sony SIO mode; SCK serial clock input. When XIICEN = Low, this pin is I <sup>2</sup> C bus mode; SCL input.
9	Vss2	—	Digital ground.
10	SYSCCLK	I	System clock input. To generate the correct subcarrier frequency, precise 27MHz is required.
11	Vss3	—	Digital ground.
12	XRST	I	System reset input in active Low. Set to Low for 40 clocks (SYSCCLK) or more during power-on reset.
13	Vss4	—	Digital ground.
14	PDCLK	O	Pixel data clock signal output for 13.5MHz. A 13.5MHz signal frequency divided from the system clock (SYSCCLK) is output and used as the clock signal when 16-bit pixel data is input.
15	VDD1	—	Digital power supply.
16	FID	I/O	Field ID input/output. When SYNCM (Pin 72) = High, the CXD1916R is set to master mode and outputs as follows. When control register bit "FIDS" = "1": Low indicates 1st field and High indicates 2nd field. When control register bit "FIDS" = "0": High indicates 1st field and Low indicates 2nd field. When SYNCM (Pin 72) = Low, the CXD1916R is set to slave mode and this pin becomes the field ID input.

Pin No.	Symbol	I/O	Description
17	VSYNC	I/O	Vertical sync signal input/output. When SYNCM (Pin 72) = High, this pin is the vertical sync signal output. When SYNCM = Low, this pin is the vertical sync signal input, and the falling edge is detected during the 1st field to reset the internal circuits.
18	HSYNC	I/O	Horizontal sync signal input/output. When SYNCM (Pin 72) = High, this pin is the horizontal sync signal output. When SYNCM = Low, this pin is the horizontal sync signal input, and the falling edge is detected during the 1st field to reset the internal circuits.
19	CSYNC	O	Composite sync output when using RGB output.
20	BF	O	Burst flag output. The burst flag is synchronized with the composite video signal (CP-OUT) and indicates its color burst signal position.
21	Vss5	—	Digital ground.
22	PD0	I	8-bit pixel data inputs, or lower 8-bit pixel data inputs when 16-bit pixel data is input. [PD0 to PD7] When control register bit "PIF MODE" = "0", these are multiplexed Y, Cb, and Cr signal inputs. When control register bit "PIF MODE" = "1", these are Y signal inputs.
23	PD1	I	
24	PD2	I	
25	PD3	I	
26	VDD2	—	Digital power supply.
27	PD4	I	8-bit pixel data inputs, or lower 8-bit pixel data inputs when 16-bit pixel data is input. [PD0 to PD7] When control register bit "PIF MODE" = "0", these are multiplexed Y, Cb, and Cr signal inputs. When control register bit "PIF MODE" = "1", these are Y signal inputs.
28	PD5	I	
29	PD6	I	
30	PD7	I	
31	Vss6	—	Digital ground.
32	PD8/TD0	I/O	Upper 8-bit pixel data inputs when 16-bit pixel data is input/test data bus. [PD8 to PD15] When control register bit "PIF MODE" = "0", these inputs are not used. When control register bit "PIF MODE" = "1", these are multiplexed Cb and Cr signal inputs. In test mode, these are used for the internal circuit test data bus. The test data bus is available only for the device vendor.
33	PD9/TD1	I/O	
34	PD10/TD2	I/O	
35	PD11/TD3	I/O	
36	Vss7	—	Digital ground.
37	PD12/TD4	I/O	Upper 8-bit pixel data inputs when 16-bit pixel data is input/test data bus. [PD8 to PD15] When control register bit "PIF MODE" = "0", these inputs are not used. When control register bit "PIF MODE" = "1", these are multiplexed Cb and Cr signal inputs. In test mode, these are used for the internal circuit test data bus. The test data bus is available only for the device vendor.
38	PD13/TD5	I/O	
39	PD14/TD6	I/O	
40	PD15/TD7	I/O	
41	VDD3	—	Digital power supply.
42	NC	—	Not connected inside the IC.
43	IREF	O	DAC reference current output. Connect resistance "16R" which is 16 times output resistance "R".
44	VREF	I	DAC reference voltage input. Sets the DAC output full-scale width.
45	CP-OUT	O	10-bit DAC output. This pin outputs the composite, B and U signals.

Pin No.	Symbol	I/O	Description
46	AV <sub>DD</sub> 1	—	Analog power supply.
47	AV <sub>SS</sub> 1	—	Analog ground.
48	C-OUT	O	10-bit DAC output. This pin outputs the chroma (C), R and V signals.
49	VB	O	Connect to ground via a capacitor of approximately 0.1μF.
50	VG	O	Connect to analog power supply via a capacitor of approximately 0.1μF.
51	Y-OUT	O	10-bit DAC output. This pin outputs the luminance (Y) and G signals.
52	AV <sub>DD</sub> 2	—	Analog power supply.
53	AV <sub>SS</sub> 2	—	Analog ground.
54	NC	—	Not connected inside the IC.
55	NC	—	Not connected inside the IC.
56	NC	—	Not connected inside the IC.
57	NC	—	Not connected inside the IC.
58	NC	—	Not connected inside the IC.
59	NC	—	Not connected inside the IC.
60	V <sub>SS</sub> 8	—	Digital ground.
61	TVSYNC	I	Test pin. This pin is pulled up. Normally this pin should be open.
62	TD8	I/O	Test data inputs/outputs. These pins should be open. In test mode, these are used for the internal circuit test data bus. The test data bus is available only for the device vendor.
63	TD9	I/O	
64	TD10	I/O	
65	V <sub>DD</sub> 4	—	Digital power supply.
66	XTEST	I	Test mode control. This pin is pulled up. Normally this pin should be open.
67	OSDSW/ XTEST1	I	These pins are pulled up. The functions of these pins are selected by XTEST (Pin 66). When XTEST = High, these are OSD data inputs. When XTEST = Low, these are test mode control inputs. The test mode is available only for the device vendor.
68	ROSD/ XTEST2	I	
69	GOSD/ XTEST3	I	
70	BOSD/ XTEST4	I	
71	XTEST5	I	Test pin. This pin is pulled up. Normally this pin should be open.
72	SYN <sub>CM</sub>	I	Master/slave switching. This pin is pulled up. When SYN <sub>CM</sub> = High, the CXD1916R is set to master mode. When SYN <sub>CM</sub> = Low, the CXD1916R is set to slave mode.
73	PIXCON	I	Control register bit "PIX_EN" default value control. This pin is pulled up.
74	V <sub>SS</sub> 9	—	Digital ground.
75	TDI	I	Test mode control input. This pin is pulled up.

---

Pin No.	Symbol	I/O	Description
76	TMS	I	Test mode control input. This pin is pulled up.
77	TDO	O	Test output. This pin should be open.
78	TCK	I	Test mode control input. Fix to High.
79	TRST	I	Test mode reset input. Set to Low for 40 clocks (SYSCLK) or more during power-on reset.
80	V <sub>DD5</sub>	—	Digital power supply.

## Electrical Characteristics

## DC Characteristics

(Ta = 0 to +70°C, Vss = 0V)

Item	Symbol	Measurement conditions	Min.	Typ.	Max.	Unit	Measurement pins
Input High voltage	V <sub>IH1</sub>	V <sub>DD</sub> = 3.3 ± 0.3V	0.7V <sub>DD</sub>		*8	V	*1
Input Low voltage	V <sub>IL1</sub>	V <sub>DD</sub> = 3.3 ± 0.3V			0.2V <sub>DD</sub>	V	*1
Input High voltage	V <sub>IH2</sub>	V <sub>DD</sub> = 3.3 ± 0.3V	0.7V <sub>DD</sub>		*8	V	*2
Input Low voltage	V <sub>IL2</sub>	V <sub>DD</sub> = 3.3 ± 0.3V			0.3V <sub>DD</sub>	V	*2
Output High voltage	V <sub>OH1</sub>	I <sub>OH</sub> = -8.0mA V <sub>DD</sub> = 3.3 ± 0.3V	V <sub>DD</sub> - 0.4			V	*3
Output Low voltage	V <sub>OL1</sub>	I <sub>OL</sub> = 8.0mA V <sub>DD</sub> = 3.3 ± 0.3V			0.4	V	*3
Output High voltage	V <sub>OH2</sub>	I <sub>OH</sub> = -4.0mA V <sub>DD</sub> = 3.3 ± 0.3V	V <sub>DD</sub> - 0.4			V	*4
Output Low voltage	V <sub>OL2</sub>	I <sub>OL</sub> = 4.0mA V <sub>DD</sub> = 3.3 ± 0.3V			0.4	V	*4
Output High voltage	V <sub>OH3</sub>	I <sub>OH</sub> = -2.0mA V <sub>DD</sub> = 3.3 ± 0.3V	2.4			V	*5
Output Low voltage	V <sub>OL3</sub>	I <sub>OL</sub> = 4.0mA V <sub>DD</sub> = 3.3 ± 0.3V			0.4	V	*5
Input leak current	I <sub>IL1</sub>	V <sub>I</sub> = 0V V <sub>DD</sub> = 3.3 ± 0.3V	-240	-100	-40	μA	*6
Input leak current	I <sub>I2</sub>	V <sub>I</sub> = 0 to 5.5V V <sub>DD</sub> = 3.3 ± 0.3V	-40		40	μA	*7
Supply current	I <sub>DD</sub>	V <sub>DD</sub> = 3.3 ± 0.3V			35*9	mA	

## Notes:

- \*1 F1, XVRST, XIICEN, XCS/SA, SYSCLK, XRST, FID, VSYNC, HSYNC, PD0 to PD15, TVSYNC, TD8 to TD10, XTEST, OSDSW, ROSD, GOSD, BOSD, XTEST5, SYNCM, PIXCON, TDI, TMS, TCK, TRST
- \*2 SI/SDA, SCK/SCL
- \*3 SO, PDCLK, CSYNC, BF
- \*4 TDO
- \*5 FID, VSYNC, HSYNC, TD0 to TD10
- \*6 XVRST, XIICEN, XCS, TVSYNC, XTEST, OSDSW, ROSD, GOSD, BOSD, XTEST5, SYNCM, PIXCON, TDI, TMS
- \*7 F1, SI/SDA, SCK/SCL, SYSCLK, XRST, FID, VSYNC, HSYNC, PD0 to PD15, TD8 to TD10, TCK, TRST
- \*8 The CXD1916R supports input from 5V devices.
- \*9 Not including analog current

**DAC Characteristics**(AV<sub>DD</sub> = 3.3V, R = 200Ω, V<sub>REF</sub> = 1.35V, Ta = 25°C)

Item	Symbol	Measurement conditions	Min.	Typ.	Max.	Unit
Resolution	n			10		bit
Linearity error	E <sub>L</sub>		-2.9		2.9	LSB
Differential linearity error	E <sub>D</sub>		-0.9		0.9	LSB
Output full-scale current	I <sub>FS</sub>		6.25	6.75	7.25	mA
Output offset voltage	V <sub>OS</sub>				2	mV
Output full-scale voltage	V <sub>FS</sub>		1.20	1.35	1.50	V
Precision guaranteed output voltage range	V <sub>OC</sub>		1.20	1.35	1.50	V



AC Characteristics

1. Serial port interface

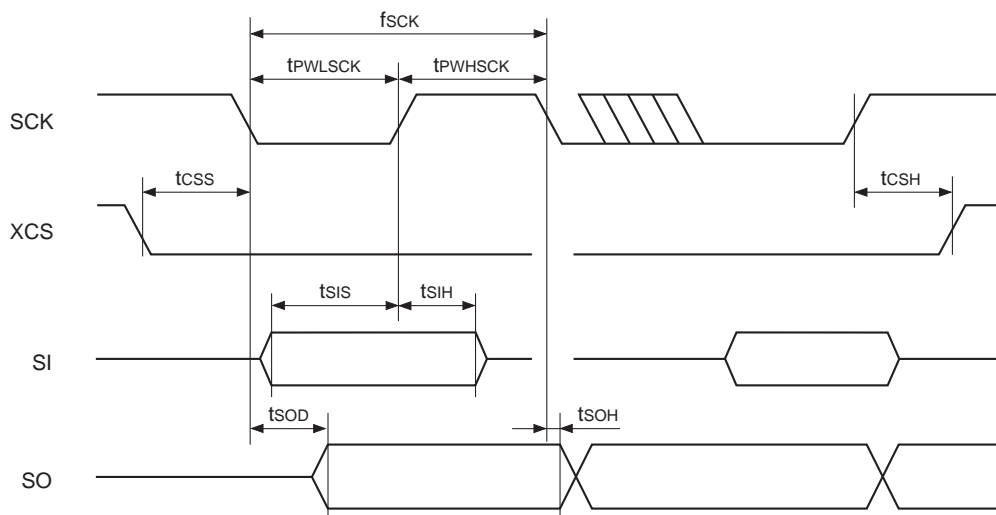

( $T_a = 0$  to  $+70^\circ\text{C}$ ,  $V_{DD} = 3.3 \pm 0.3\text{V}$ ,  $V_{SS} = 0\text{V}$ )

Item	Symbol	Min.	Typ.	Max.	Unit
SCK clock rate	$f_{SCK}$	DC		3	MHz
SCK pulse width Low	$t_{PWL\_SCK}$	100			ns
SCK pulse width High	$t_{PWH\_SCK}$	100			ns
Chip select setup time to SCK	$t_{CSS}$	150			ns
Chip select hold time to SCK	$t_{CSH}$	150			ns
Serial input setup time to SCK	$t_{SIS}$	50			ns
Serial input hold time to SCK	$t_{SIH}$	10			ns
Serial output delay time from SCK	$t_{SOD}^*$			30	ns
Serial output hold time from SCK	$t_{SOH}^*$	3			ns

\*  $C_L = 35\text{pF}$

2. F1

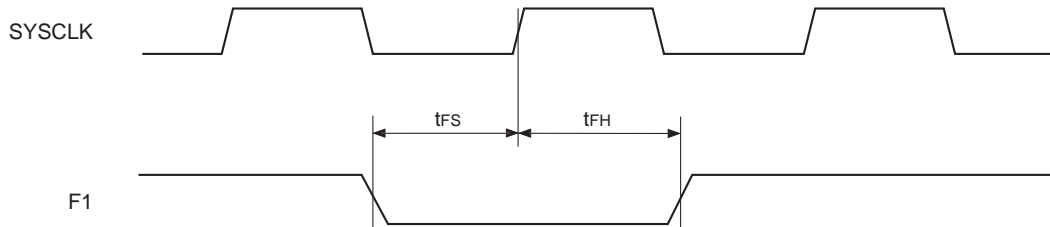

(Ta = 0 to +70°C, VDD = 3.3 ± 0.3V, Vss = 0V)

Item	Symbol	Min.	Typ.	Max.	Unit
F1 setup time to SYSCLK	t <sub>FS</sub>	10			ns
F1 hold time to SYSCLK	t <sub>FH</sub>	5			ns

3. OSDSW, ROSD, GOSD, BOSD

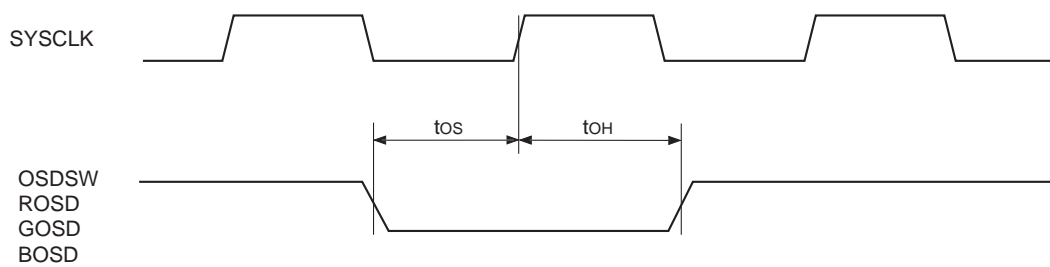

(Ta = 0 to +70°C, VDD = 3.3 ± 0.3V, Vss = 0V)

Item	Symbol	Min.	Typ.	Max.	Unit
OSD setup time to SYSCLK	t <sub>OS</sub>	10			ns
OSD hold time to SYSCLK	t <sub>OH</sub>	4			ns

4. SYSCLK, PDCLK, BF, CSYNC, HSYNC, VSYNC, FID

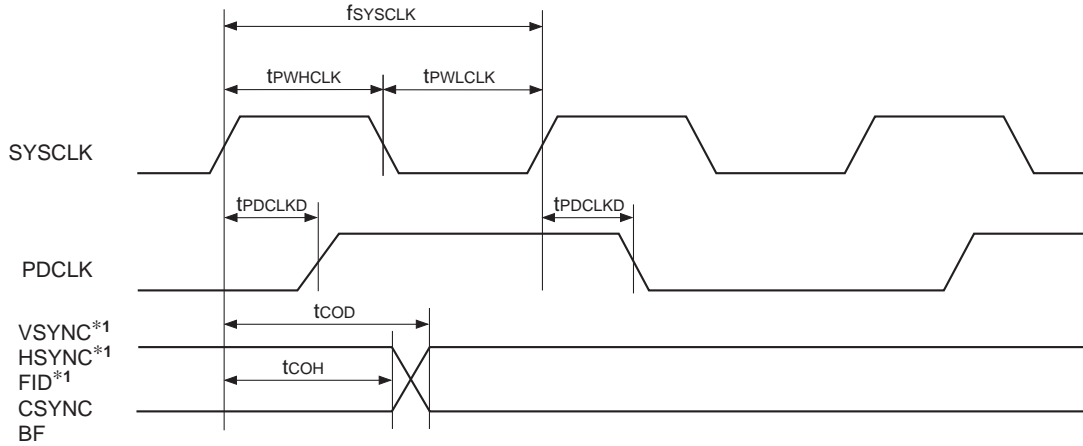

\*1 In master mode

(Ta = 0 to +70°C, VDD = 3.3 ± 0.3V, VSS = 0V)

Item	Symbol	Min.	Typ.	Max.	Unit
SYSCLK clock rate	f <sub>SYSCLK</sub>		27		MHz
SYSCLK pulse width Low	t <sub>PWLCLK</sub>	11			ns
SYSCLK pulse width High	t <sub>PWHCLK</sub>	11			ns
PDCLK delay time from SYSCLK	t <sub>PDCLKD</sub> *			20	ns
Control output delay time from SYSCLK	t <sub>COD</sub> *			26	ns
Control output hold time from SYSCLK	t <sub>COH</sub> *	3			ns

\* CL = 35pF

5. 8-bit mode

(1) Pixel data interface

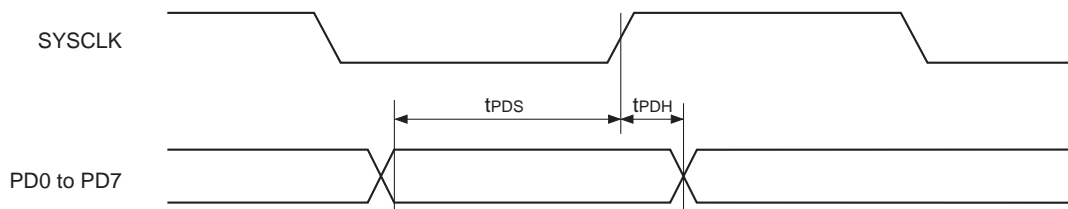

(Ta = 0 to +70°C, VDD = 3.3 ± 0.3V, VSS = 0V)

Item	Symbol	Min.	Typ.	Max.	Unit
Pixel data setup time to SYSCLK	t <sub>PDS</sub>	10			ns
Pixel data hold time to SYSCLK	t <sub>PDH</sub>	5			ns

(2) XVRST

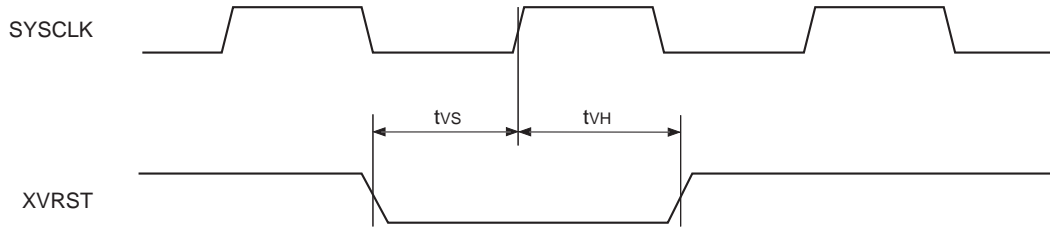

(Ta = 0 to +70°C, VDD = 3.3 ± 0.3V, Vss = 0V)

Item	Symbol	Min.	Typ.	Max.	Unit
XVRST setup time to SYSCLK	t <sub>vs</sub>	10			ns
XVRST hold time to SYSCLK	t <sub>vH</sub>	3			ns

(3) HSYNC, VSYNC, FID

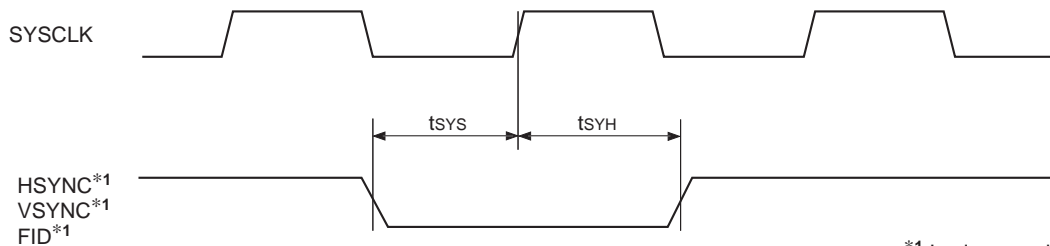

\*1 In slave mode

(Ta = 0 to +70°C, VDD = 3.3 ± 0.3V, Vss = 0V)

Item	Symbol	Min.	Typ.	Max.	Unit
Sync signal setup time to SYSCLK	t <sub>sys</sub>	10			ns
Sync signal hold time to SYSCLK	t <sub>syH</sub>	5			ns

6. 16-bit mode

(1) Pixel data interface

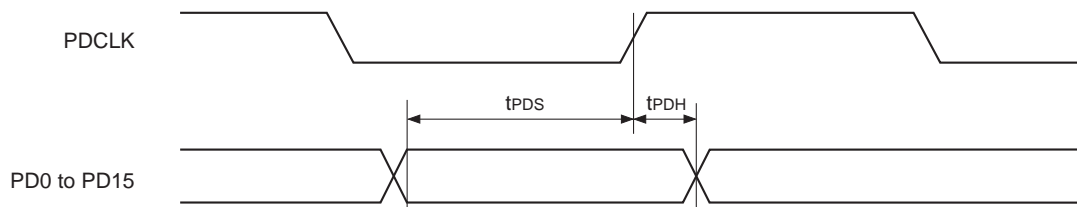

( $T_a = 0$  to  $+70^\circ\text{C}$ ,  $V_{DD} = 3.3 \pm 0.3\text{V}$ ,  $V_{SS} = 0\text{V}$ )

Item	Symbol	Min.	Typ.	Max.	Unit
Pixel data setup time to PDCLK	$t_{PDS}$	20			ns
Pixel data hold time to PDCLK	$t_{PDH}$	0			ns

(2) XVRST

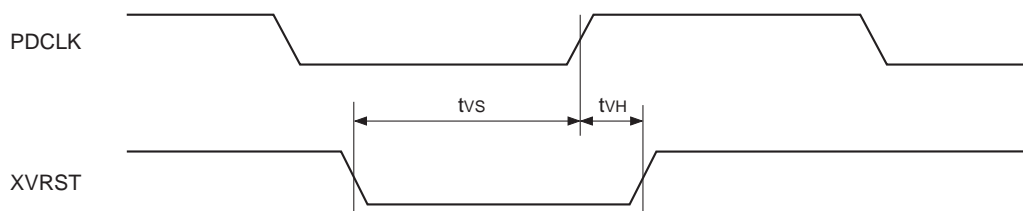

( $T_a = 0$  to  $+70^\circ\text{C}$ ,  $V_{DD} = 3.3 \pm 0.3\text{V}$ ,  $V_{SS} = 0\text{V}$ )

Item	Symbol	Min.	Typ.	Max.	Unit
XVRST setup time to PDCLK	$t_{vs}$	23			ns
XVRST hold time to PDCLK	$t_{vH}$	0			ns

(3) HSYNC, VSYNC, FID

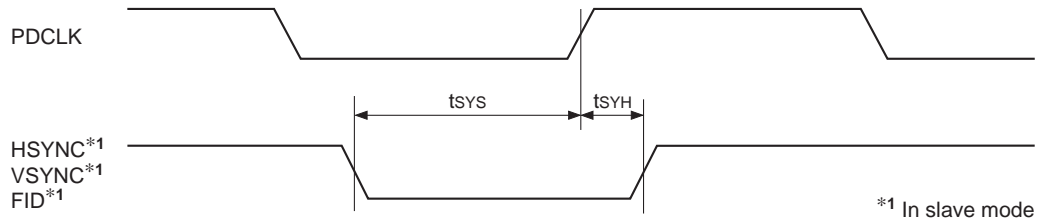

( $T_a = 0$  to  $+70^{\circ}\text{C}$ ,  $V_{DD} = 3.3 \pm 0.3\text{V}$ ,  $V_{SS} = 0\text{V}$ )

Item	Symbol	Min.	Typ.	Max.	Unit
Sync signal setup time to PDCLK	$t_{SYS}$	20			ns
Sync signal hold time to PDCLK	$t_{SYH}$	0			ns

## Description of Functions

The CXD1916R converts digital parallel data (ITU-R601 Y, Cb, Cr) into analog TV signals in NTSC (RS170A) or PAL (ITU-R624; B, G, H, I) format.

The CXD1916R first receives image data in 8-bit parallel form (multiplexed Y, Cb, and Cr data), or in 16-bit parallel form (8-bit Y and 8-bit multiplexed Cb and Cr data). After demultiplexing, it converts the Cb and Cr signals into the U and V signals, respectively, interpolates 4:2:2 to 4:4:4, and then modulates the signals with the digital subcarrier inside the CXD1916R to create the chroma (C) signal.

The Y and chroma (C) signals are oversampled at double speed to reduce SIN (X)/(X) roll-off, and then added to become the digital composite signal.

The 10-bit DAC converts the digital composite, Y/C, U, V, and RGB signals into analog signals.

### 1. Pixel input format

The pixel input format is selected according to the value of bit 4 (PIF MODE) of control register address 01H as shown in Table 1-1 below.

When "PIF MODE" is "0", the image data (multiplexed Y, Cb, and Cr data) input from PD0 to PD7 are sampled at the rising edge of SYSCLK as shown in the chart on the following page. When "PIF MODE" is "1", the image data (PD0 to PD7: Y data, PD8 to PD15: multiplexed Cb and Cr data) input from PD0 to PD15 are sampled at the rising edge of PDCLK.

PIF Mode	PD15 to 8	PD7 to 0
0 (8 bit mode)	NA	Y/Cb/Cr
1 (16 bit mode)	Cb/Cr	Y

**Table 1-1**

Also, the pixel input data timing is determined according to bits 3 and 2 (PIX TIM) of control register address 01H as shown in Table 1-2 below.

When "PIF MODE" is "0", Cb0 of the image data (Cb0, Y0, Cr0 and Y1) input from PD0 to PD7 is sampled at the respective rising edge of SYSCLK after the fall of HSYNC.

(Default: Cb0 is sampled at the rising edge of the second SYSCLK after the fall of HSYNC.)

When "PIF MODE" is "1", Y0 and Y1 data are input to PD0 to PD7, multiplexed Cb0 and Cr0 data are input to PD8 to PD15, and Y0 and Cb0 are sampled at the respective rising edge of PDCLK after the fall of HSYNC.

(Default: Y0 and Cb0 are sampled at the rising edge of the second PDCLK after the fall of HSYNC.)

PIX TIM		Timing phase
0	0	#0 (default)
0	1	#1
1	0	#2
1	1	#3

**Table 1-2**

Pixel Data Input Timing

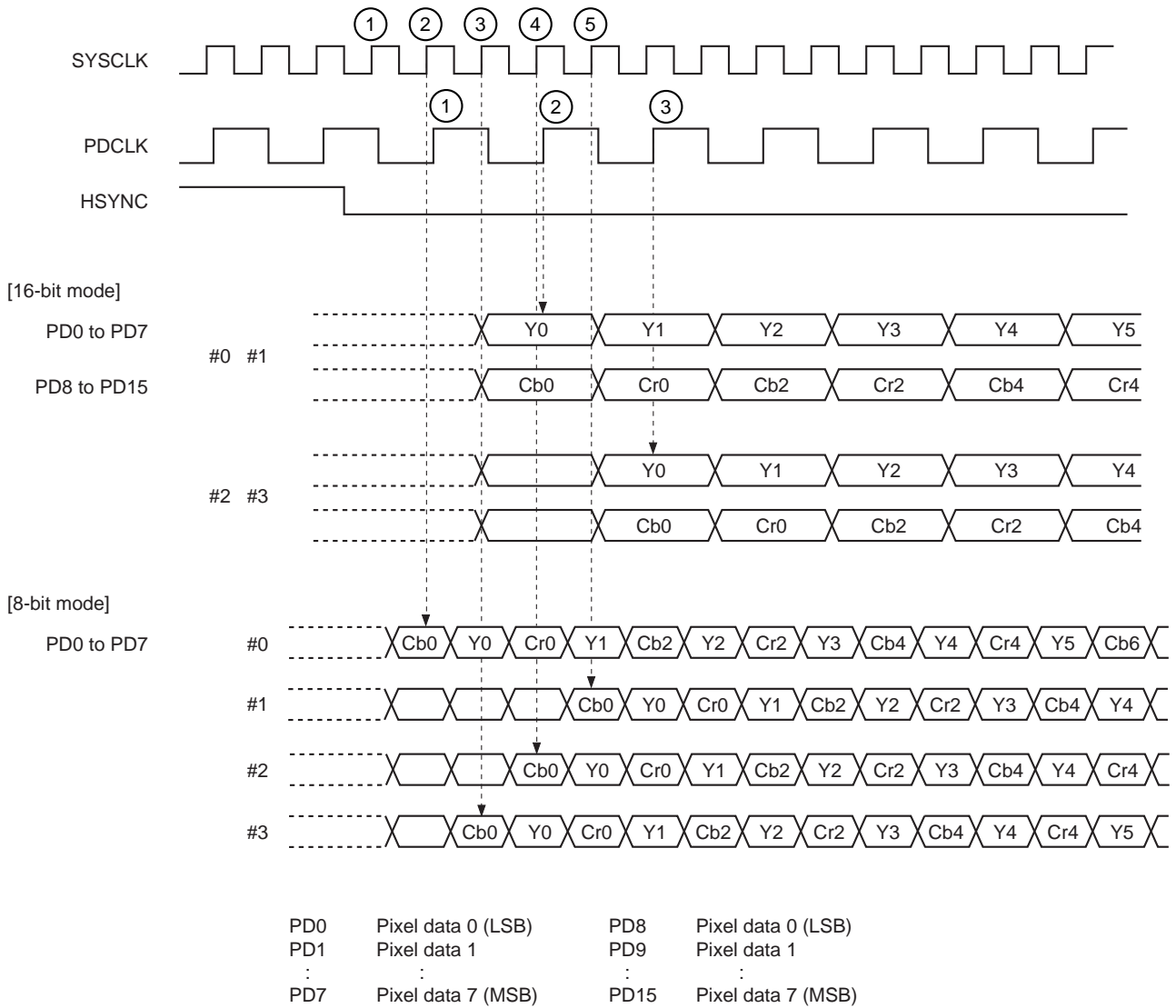



**2. Serial interface**

The CXD1916R supports both the I<sup>2</sup>C bus (high-speed mode) and Sony serial interface modes. These modes can be selected by the XIICEN input pin as shown in Table 2-1 below.

XIICEN	H	L
	SONY SIO Mode	I <sup>2</sup> C Mode
SI/SDA	SI	SDA
SCK/SCL	SCK	SCL
XCS/SA	XCS	SA
SO	SO	High-Z

**Table 2-1**

**2-1. I<sup>2</sup>C bus interface**

The CXD1916R becomes an I2C bus slave transceiver, and supports the 7-bit slave address and the high-speed mode (400K bits/s).

**2-1-1 Slave address**

Two kinds of slave address (88H, 8CH) can be selected by the SA signal as shown in Table 2-2 below.

A6	A5	A4	A3	A2	A1	A0	R/W
1	0	0	0	1	SA	0	X

**Table 2-2**

**2-1-2. Write cycle**

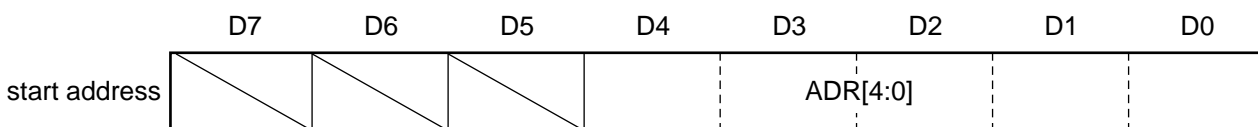
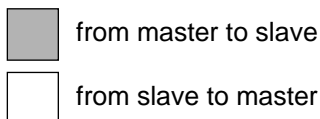
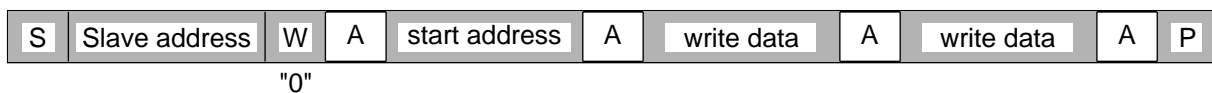

After the slave address is supplied from the master, the data in the next transfer cycle is set up inside the start address register of this IC as the start address of the control register. In subsequent cycles, the data supplied from the master is written in the addresses indicated by the control register address. The set control register address is automatically incremented with the transfer completion of each byte of data.

### 2-1-3. Read cycle

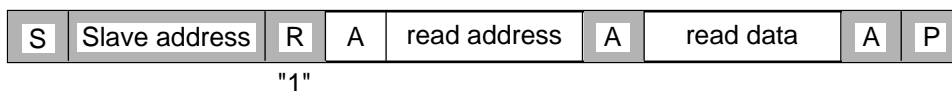

 from master to slave

 from slave to master

After the slave address is supplied from the master, subsequent cycles change immediately to read cycles and only the ID code (address 0CH, 0DH) is read out. During the read cycle, the start address is automatically set to 0CH.

**Note:** In Sony SIO mode, addresses from 00H to 0DH can be read out.

### 2-1-4. Handling of general call address (00H)

The general call address is ignored and there is no ACK response.

**2-2. Sony serial interface**

The Sony serial interface uses the SCK, XCS, SI and SO signals.

The serial interface is active when the XCS signal is Low and transmits and receives signals to and from the host.

The first byte after the XCS signal becomes Low is set up as a serial control command. Its data includes a control register address and read/write mode information for the interface. (See 2-2-1. Serial control command format.)

The control register address is automatically incremented with the transfer completion of each byte of data. In write mode, the SI signal of the serial input data is sampled at the rising edge of the SCK signal. In read mode, the register value is read out as the SO signal of the serial output data at the falling edge of the SCK signal, and is variable. In this case, the SI signal of the serial input data is ignored.

**Serial Interface Timing**

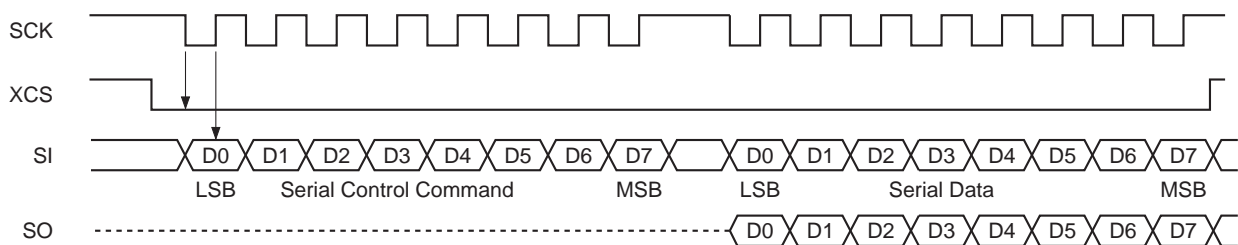

**Serial Interface Sequence**

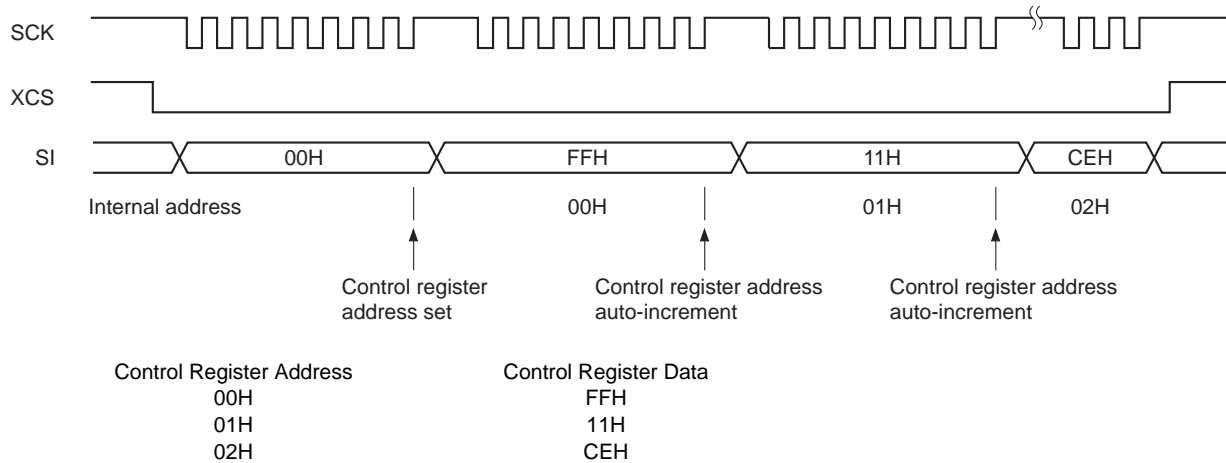

**2-2-1. Serial control command format**

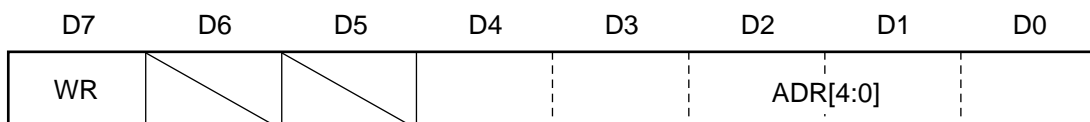

WR: Read/write mode  
 When this bit is "1":  
 The serial interface is write mode, and the SI signal of the serial input data is written in the register.  
 When this bit is "0":  
 The serial interface is read mode, and the register value is read out as the SO signal of the serial output data.  
 ADR[4:0]: Control register address setting (Initial value of the address)

3. XVRST, F1

The XVRST and F1 signals are used to synchronize with the external V sync.

The XVRST and F1 signals are sampled at the rising edge of SYSCLK, and the F1 signal is sampled when XVRST is Low. When F1 is High, the internal sync generator is reset to the 1st field, and when F1 is Low, it is reset to the 2nd field. When XVRST is set to High, the digital sync generator starts operation, and the sequence of the 1st or 2nd field starts.

[8-bit mode]

XVRST Timing (1st Field)

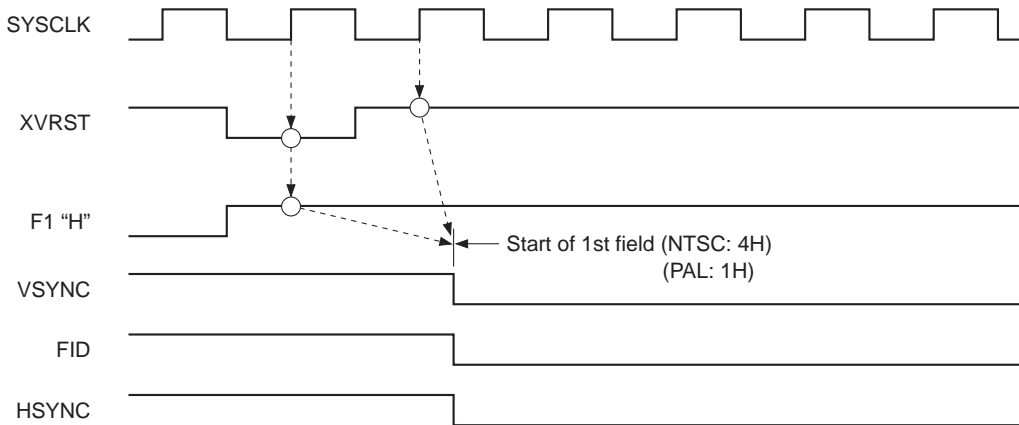

XVRST Timing (2nd Field)

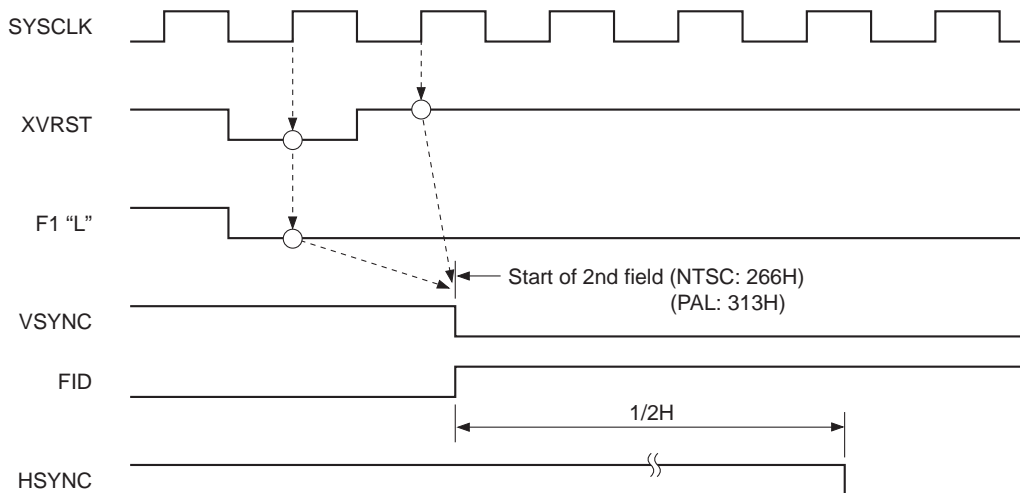

[16-bit mode]

XVRST Timing (1st Field)

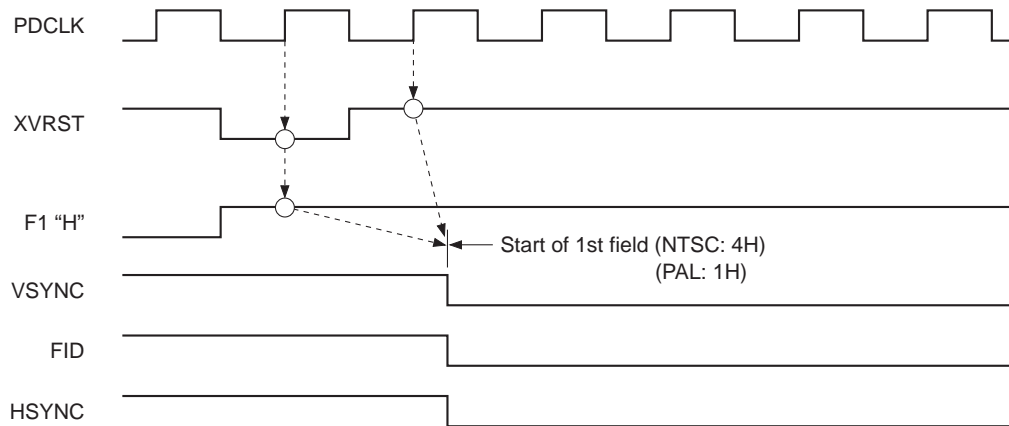

XVRST Timing (2nd Field)

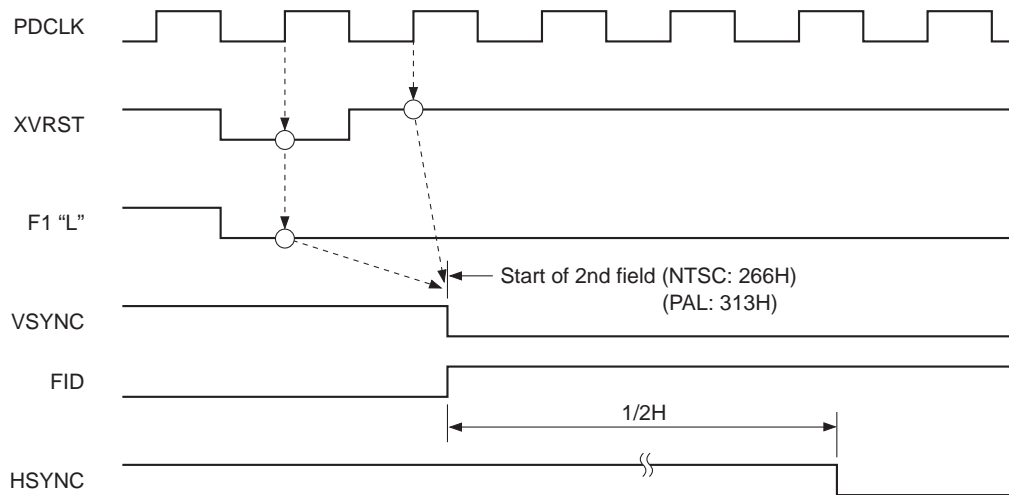

**4. External synchronization**

The CXD1916R can select master or slave operation using the SYNCM input pin.

When the SYNCM signal is Low, the CXD1916R is set to slave mode, and synchronizes to an external source using the HSYNC, VSYNC and FID I/O pin inputs.

The signal combinations used for external synchronization are set by bit 7 (SSEL) of control register 03H.

Register setting	HSYNC	VSYNC	FID
1	Used	Ignored	Used
0 (default)	Used	Used	Ignored

**4-1. V synchronization**

4-1-1. When SSEL = 0 (default), the CXD1916R identifies the data as the 1st field when the falling edges of the HSYNC and VSYNC signals match, or as the 2nd field when the falling edges do not match. The CXD1916R performs synchronization reset only during the 1st field.

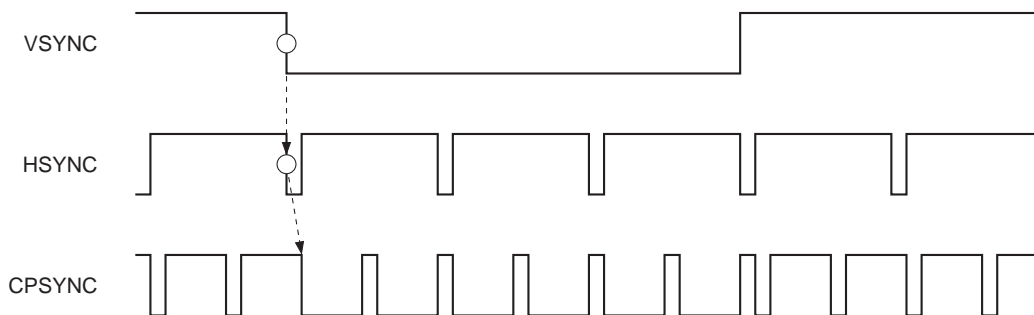

4-1-2. When SSEL = 1, operation is reset to the 1st field at the falling edge of the FID signal. In this case, set bit 7 (FIDS) of control register 00H to High (default).

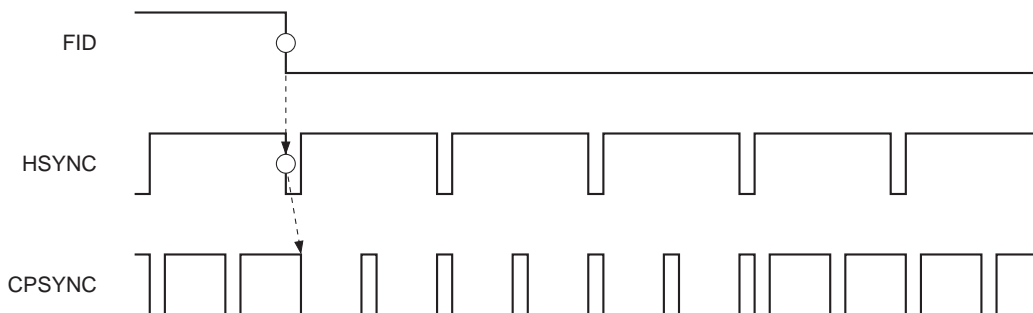

**4-2. H synchronization**

The horizontal line is reset by detecting the falling edge of the HSYNC signal.

Be sure to perform reset at the precise period.

5. Closed caption

The CXD1916R supports closed caption encoding.

ASCII data for closed captions are encoded in line 21 and line 284 by adding a parity bit to every ASCII data set up in control registers 04H, 05H (data #1 and #2 for line 21) and 06H, 07H (data #1 and #2 for line 284). The control registers (04H to 07H) are double-buffered and ASCII data, which are set up by the serial interface, are synchronized with the VSYNC signal.

Automatic reset on/off can be selected for ASCII data which has been synchronized with VSYNC by changing the setting of bit 5 (CCRST) of control register address 03H.

When CCRST = "1", the control registers (04H, 05H or 06H, 07H) are automatically reset in sync with the rise of the next VSYNC.

When CCRST = "0" (default), the control registers (04H, 05H or 06H, 07H) are not reset, and the data set last is held.

Closed Caption Data Renewal Timing

When CCRST = "1"

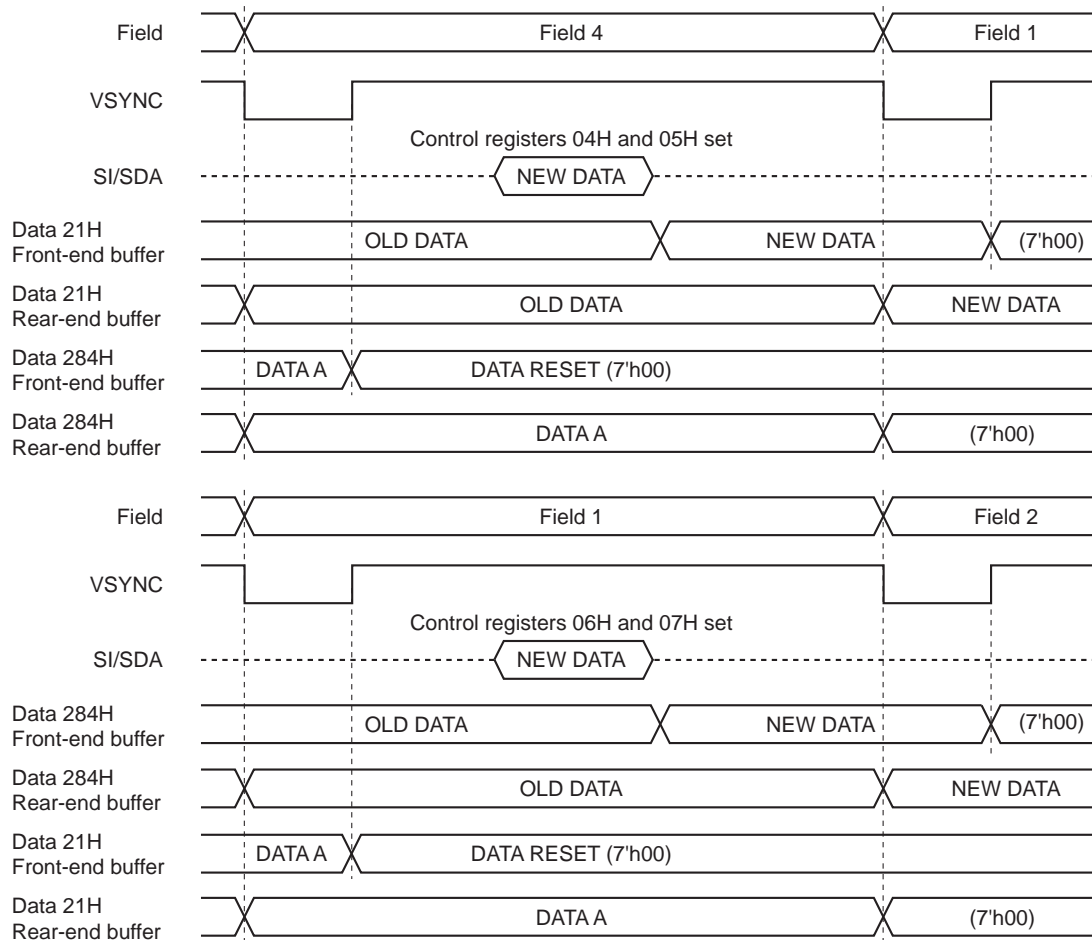

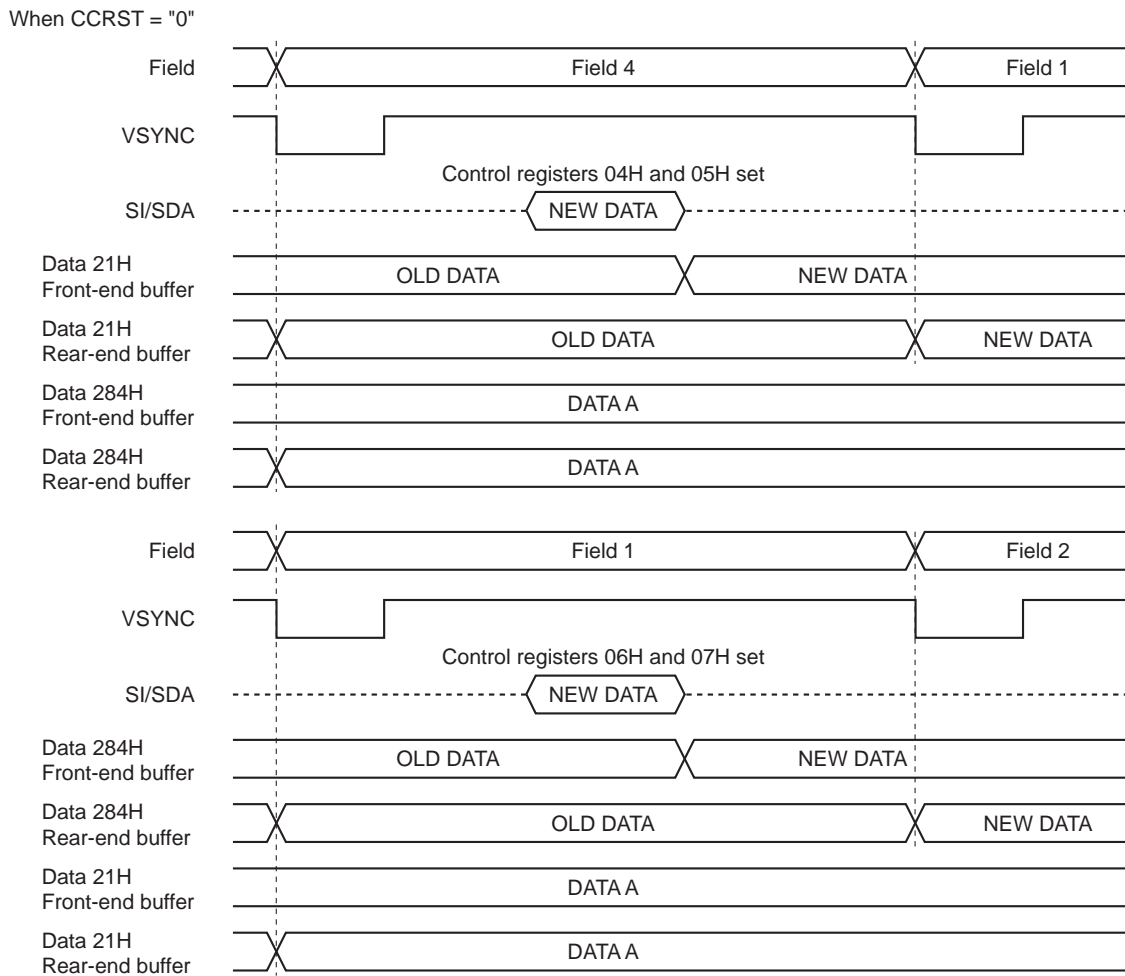

**Double Buffer for Closed Caption**

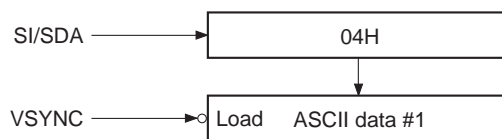

**Closed Caption Signal Waveform**

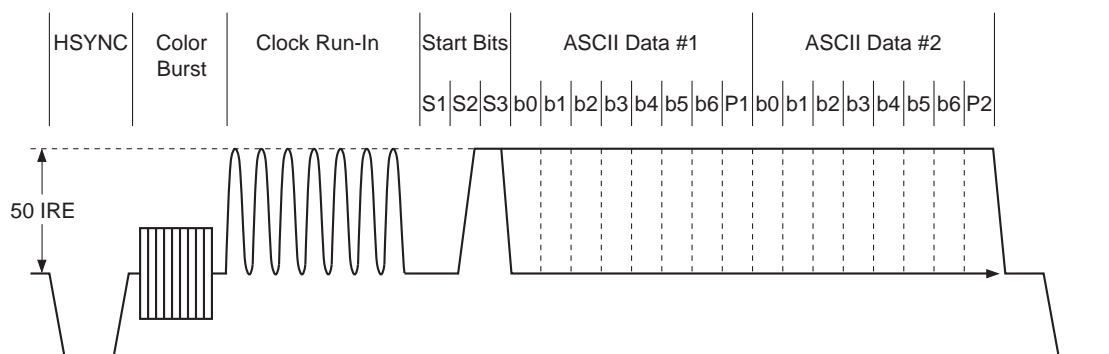



**6. VBID (Video ID)**

The CXD1916R supports encoding of Video ID (Provisional Standard EIAJ CPX-1204) to discriminate the aspect ratio. VBID is 14-bit data as shown in Table 6-1, and becomes 20-bit data with the addition of 6-bit CRCC. These data are superimposed on lines 20 and 283 during the vertical blanking period of NTSC video signals and output.

The data setting in Table 6-1 below is done by writing data in control registers (08H and 09H) via the serial interface. These control registers (08H and 09H) are double-buffered, and the VBID data are renewed in sync with the VSYNC signal.

		bit-No.	Contents	Contents		
				"1"	"0"	
Word 0	A	1	Transmission aspect ratio	Full-mode (16:9)	4:3	
		2	Image display format	Letter-box	Normal	
		3	Undefined			
	B	4	Identification information about video and other signals (audio signals, etc.) incidental to images which are transmitted simultaneously			
		5				
		6				
Word 1		4-bit width	Identification signal incidental to Word 0			
Word 2		4-bit width	Identification signal and information incidental to Word 0			

**Table 6-1**

**Double Buffer for VBID**

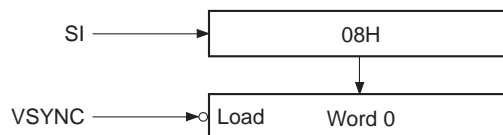

**VBID Data Renewal Timing**

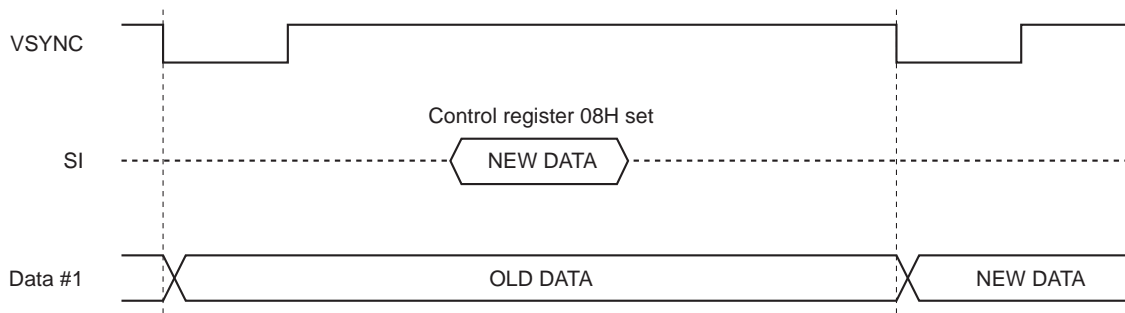

**VBID Code Allocation**

The VBID data are composed of Word 0 = 6 bits (Word 0-A = 3 bits and Word 0-B = 3 bits), Word 1 = 4 bits, Word 2 = 4 bits, and CRCC = 6 bits.

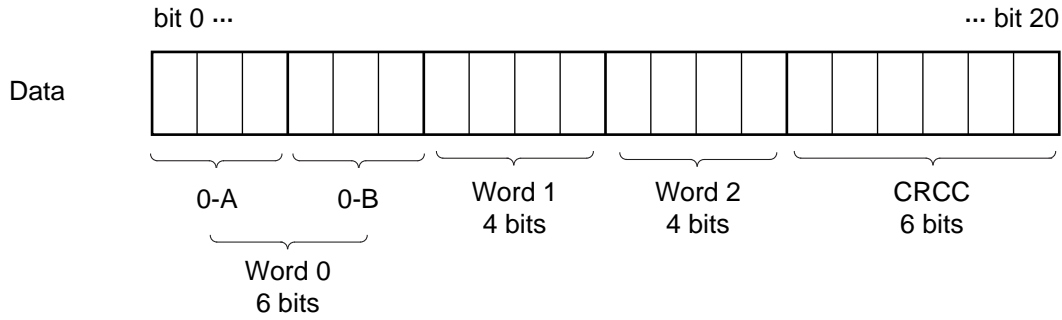

**VBID Signal Waveform**

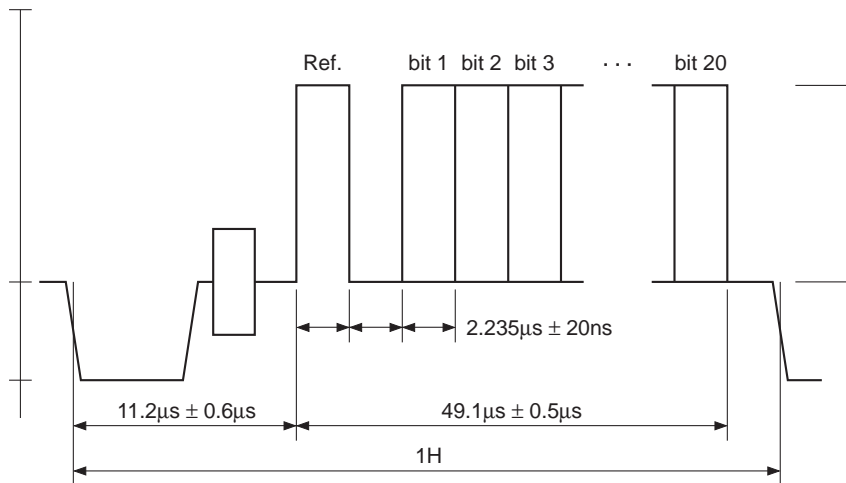

**7. WSS (Widescreen Signaling)**

The CXD1916R supports WSS encoding to discriminate the aspect ratio. WSS is 14-bit data as shown in Table 7-1. These data are superimposed on line 23 during the vertical blanking period of PAL video signals and output.

The data setting in Table 7-1 below is done by writing data in control registers (0AH and 0BH) via the serial interface. These control registers (0AH and 0BH) are double-buffered, and the WSS data are renewed in sync with the VSYNC signal.

Group 1 Aspect ratio information (4 bits) b0 to b3	Group 2 PAL plus related information (4 bits) b4 to b7
0001 Normal	bit 4 Camera/Film mode bits 5 to 7 Reserved (Color plus) (Helper) (BasebandHelper)
1000 Letter-box 14:9 Center	
0100 Letter-box 14:9 Top	
1101 Letter-box 16:9 Center	
0010 Letter-box 16:9 Top	
1011 Letter-box > 16:9 Center	
0111 Full-mode 14:9	
1110 Full-mode 16:9	

\* b3 is odd parity.

Group 3 Subtitle information (3 bits) b8 to b10	Group 4 Undefined (3 bits) b11 to b13
Bit 8 TeleText subtitle enable/disable Bits 9, 10 00 No subtitle 10 Subtitle inside screen 01 Subtitle in black portion 11 Reserved	Reserved

**Table 7-1**

**Double Buffer for WSS**

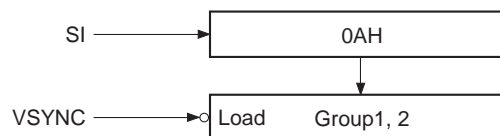

**WSS Data Renewal Timing**

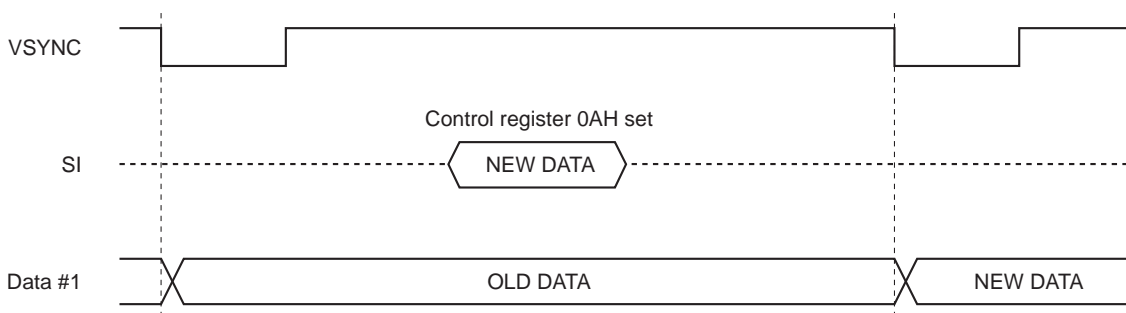

**WSS Signal Waveform**

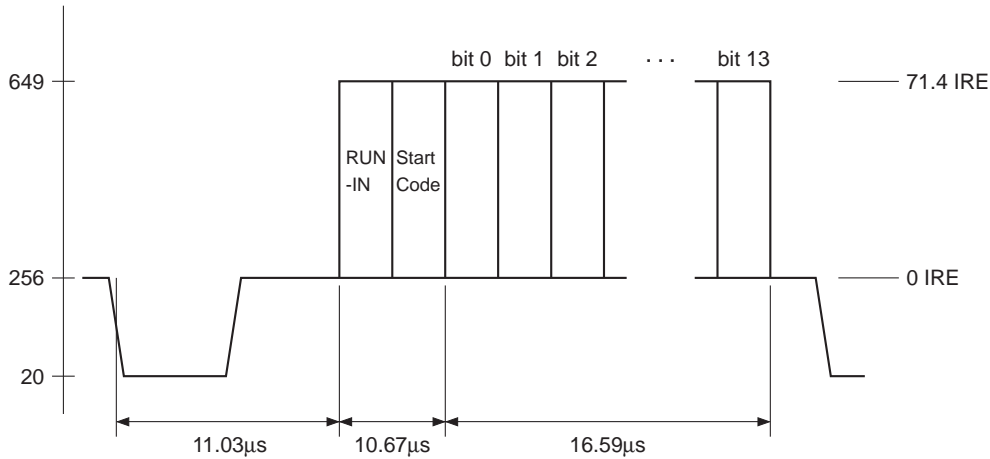

**8. RGB\*1/YUV output**

The CXD1916R has an RGB/YUV output function. RGB and YUV can be switched by setting bit 2 (RGB\_UV) and bit 4 (RGB\_CP) of control register address 03H.

Also, the UV level can be selected from BetaCam or SMPTE by setting bit 0 (BTCM) of address 03H. During RGB output, when bit 1 (GSYNC) of control register address 03H is "1", the sync signal is added to the G signal and output; when bit 1 (GSYNC) is "0", the sync signal is not added.

Register setting value		Output mode
RGB_CP	RGB_UV	
0	X	Y, C, CP (default)
1	0	Y, U, V
1	1	R, G, B

\*1 The CXD1916R supports RGB output, but if Y, Cb and Cr values in excess of 1Vp-p are input as RGB output, overflow occurs and the proper colors may not be output.

**9. Support of interlace/non-interlace modes**

The CXD1916R can be switched to the interlace and non-interlace modes by varying the setting of bit 1 (INTERLS) of control register address 01H. During the non-interlace mode, the 1st field is repeatedly output.

Register setting value INTERLS	Number of lines/field	
	NTSC	PAL
0 (non-interlace)	262	312
1 (interlace)	262.5	312.5

## 10. Support of NTSC, PAL, MPAL and 4.43NTSC

The CXD1916R can convert to NTSC, PAL, MPAL and 4.43NTSC analog TV signals by setting bits 2, 1 and 0 (ENC MODE) of control register address 00H.

Register setting value ENC MODE			Encoding mode	Number of lines/field	Subcarrier line phase difference	Subcarrier frequency [MHz]
0	0	0	PAL	625/50	$\pm 135^\circ$	4.4336 (10 $\pm$ 1 cycles)
0	0	1	NTSC	525/60	$\pm 180^\circ$	3.5795 (9 $\pm$ 1 cycles)
0	1	1	MPAL	525/60	$\pm 135^\circ$	3.5756 (9 $\pm$ 1 cycles)
1	0	1	4.43NTSC	525/60	$\pm 180^\circ$	4.4336

## 11. OSD

The CXD1916R can be switched to OSD mode by setting bit 6 (OSDEN) of control register address 02H. At this time, if OSDSW (Pin 67) = 1, the OSD input pin is enabled.

Also, the luminance level can be selected from the four levels of 25%, 50%, 75% and 100% by varying the setting of bits 5 and 4 (Y\_LEV) of control register address 02H. This allows 29-color (7 colors  $\times$  4 levels + black) OSD output. (Up to 8 colors can be displayed at once.)

Color	ROSD (Pin 68)	GOSD (Pin 69)	BOSD (Pin 70)
White	1	1	1
Yellow	1	1	0
Cyan	0	1	1
Green	0	1	0
Magenta	1	0	1
Red	1	0	0
Blue	0	0	1
Black	0	0	0

## 12. Support of square pixels

The CXD1916R can be switched to support square pixels by setting bit 4 (SQPIX) of control register address 00H.

MPAL and 4.43NTSC cannot be used in square pixel mode.

Register setting value SQPIX	Mode	Pixel clock frequency [MHz]	
		NTSC	PAL
0	Normal mode	13.5	13.5
1	Square pixel mode	12.272727	14.75

## 13. On-chip 100% color bar generator

The CXD1916R can display an ITU\_R100% color bar from its internal generator by setting bit 7 (CBAR) of control register address 02H.

**14. ITU-656EAV decoding**

The CXD1916R decodes the EAV of the ITU-656 1st field and performs internal synchronization every 4 fields for NTSC or every 8 fields for PAL by setting bit 3 (D1 MODE) of control register address 03H.

Signal Waveform of NTSC Vertical Blanking Period (Interlace mode)

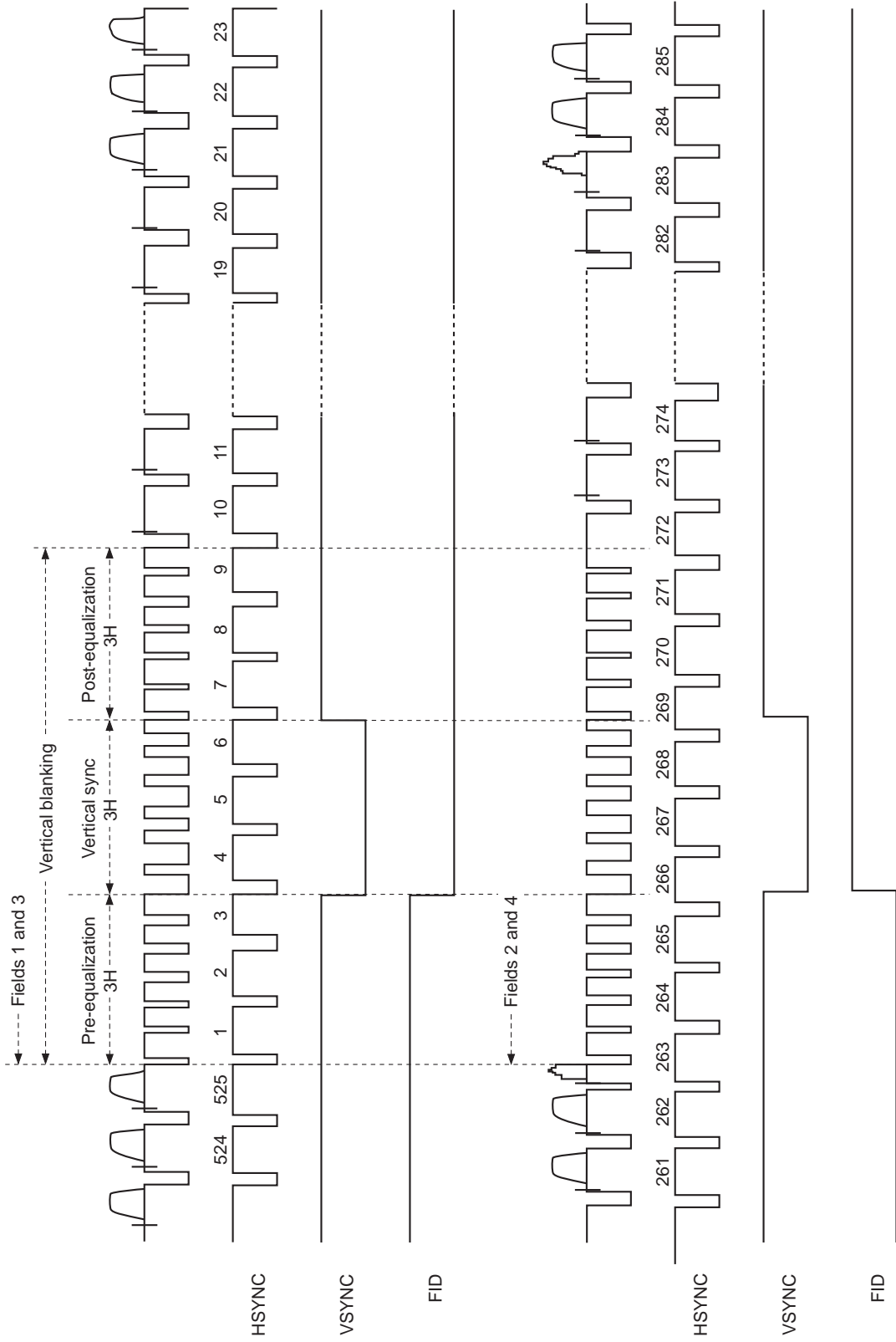

Signal Waveform of PAL Vertical Blanking Period (Interlace mode)

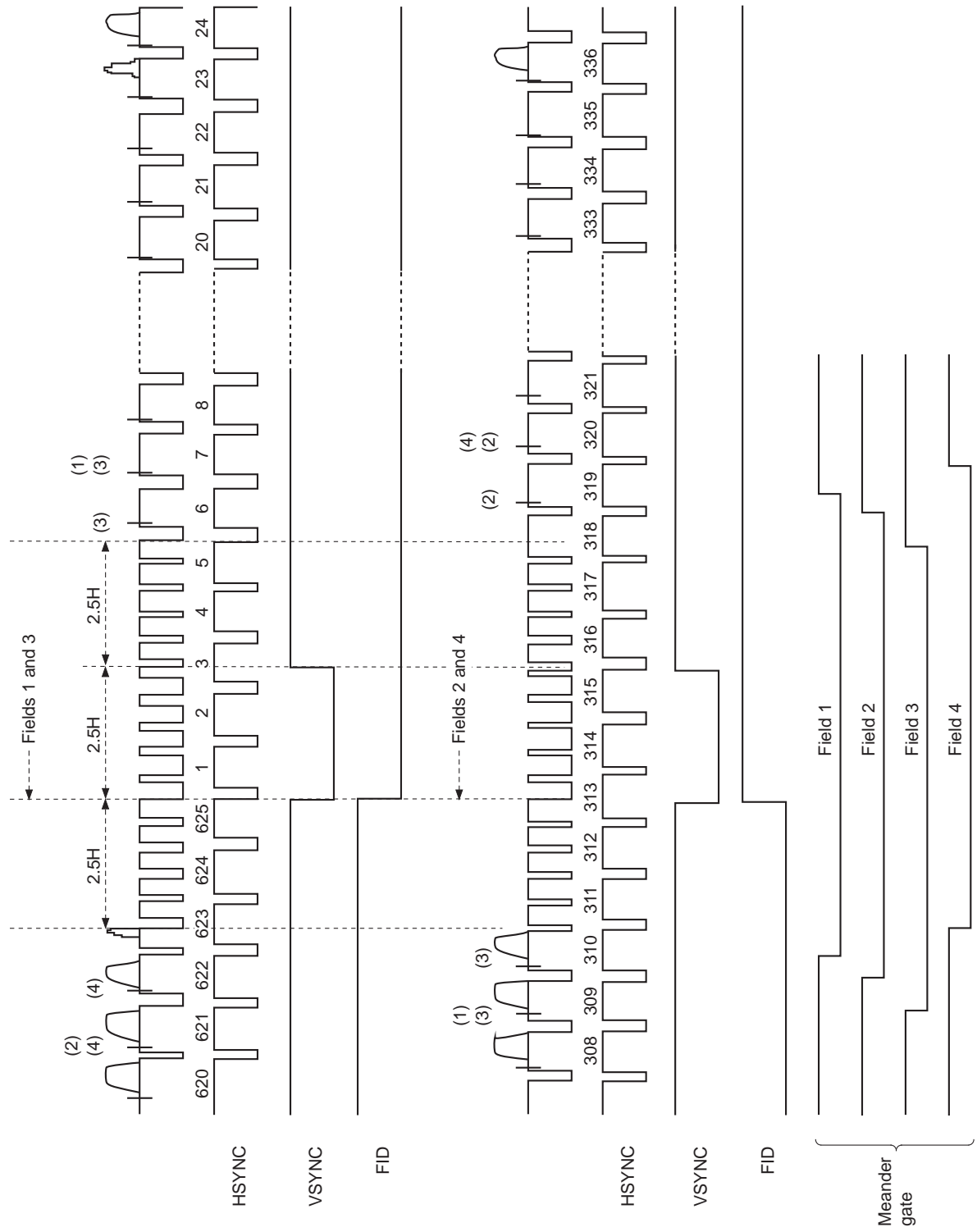



Signal Waveform of NTSC Vertical Blanking Period (Non-interlace mode)

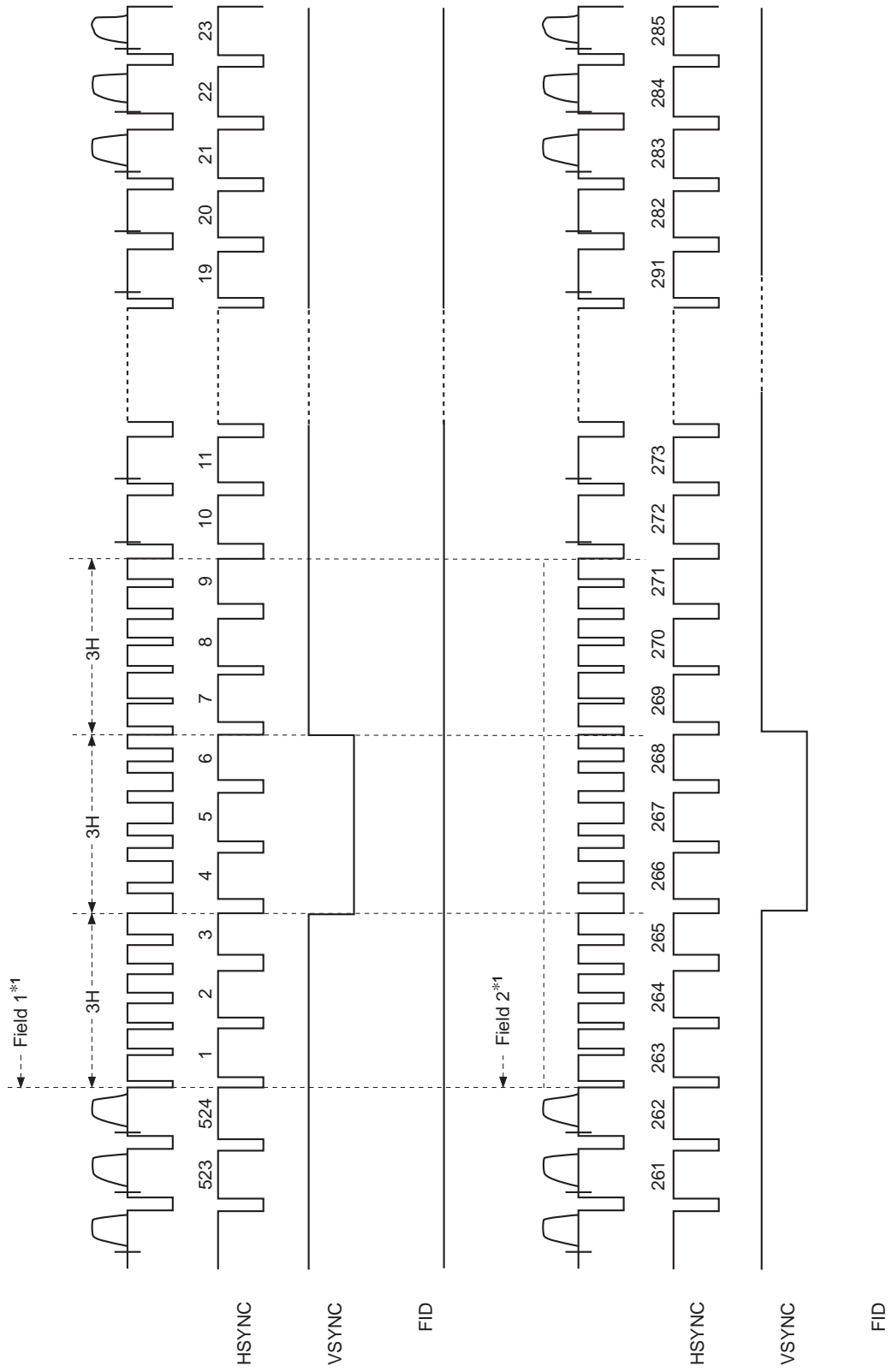

\*1 No differentiation is made between Fields 1 and 2 to facilitate the frame description.

Signal Waveform of PAL Vertical Blanking Period (Non-interlace mode)

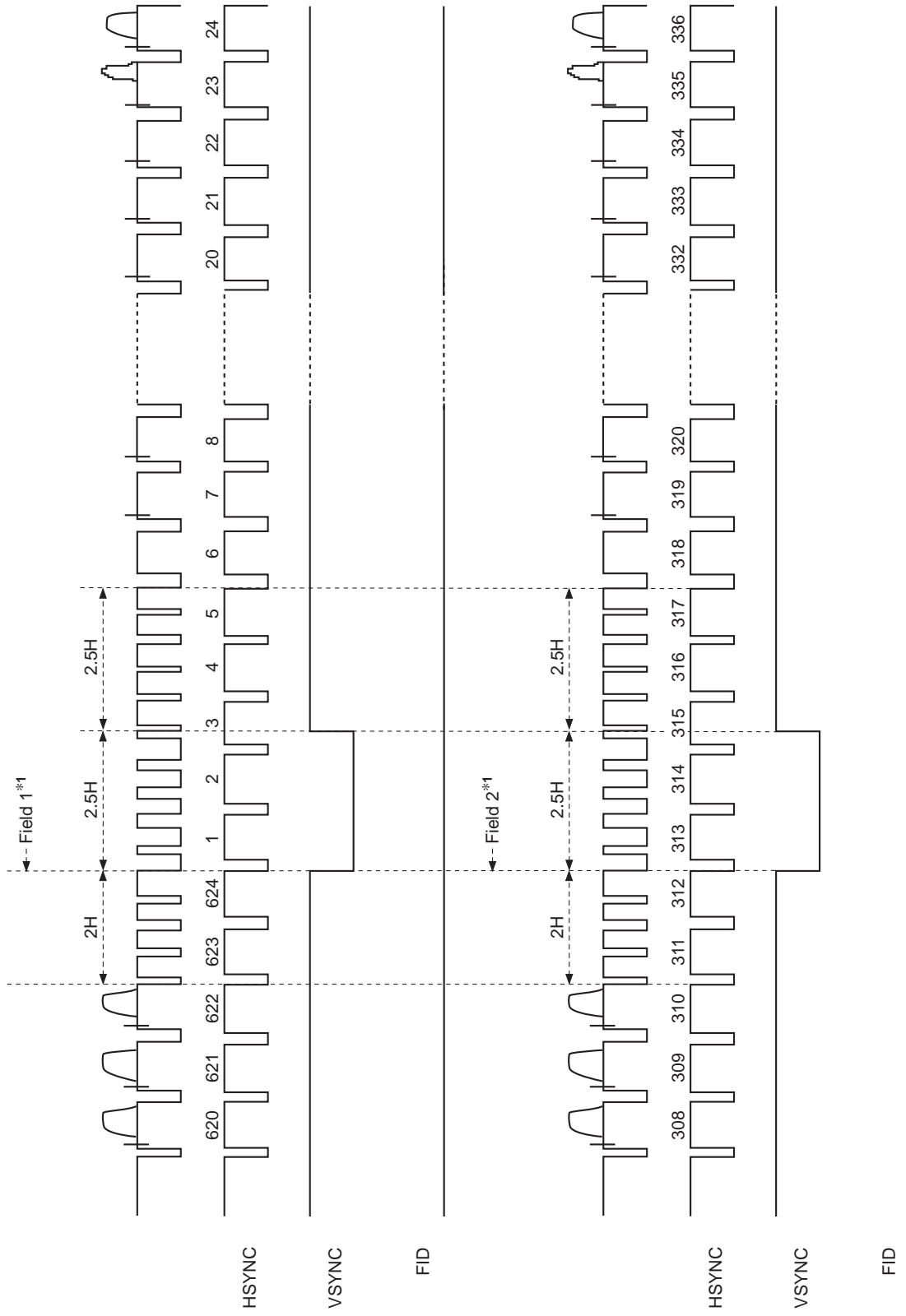

\*1 No differentiation is made between Fields 1 and 2 to facilitate the frame description.

Sync Signal Timing

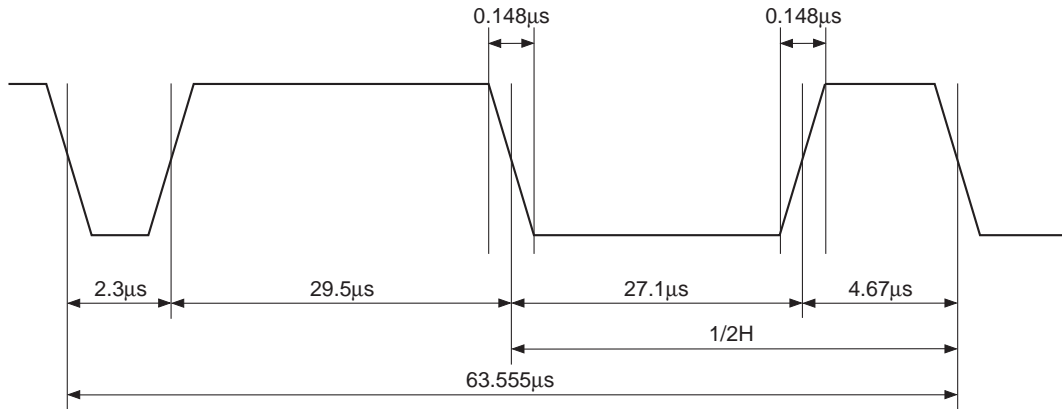

NTSC Equalizing Pulse and Sync Pulse Signal Waveform

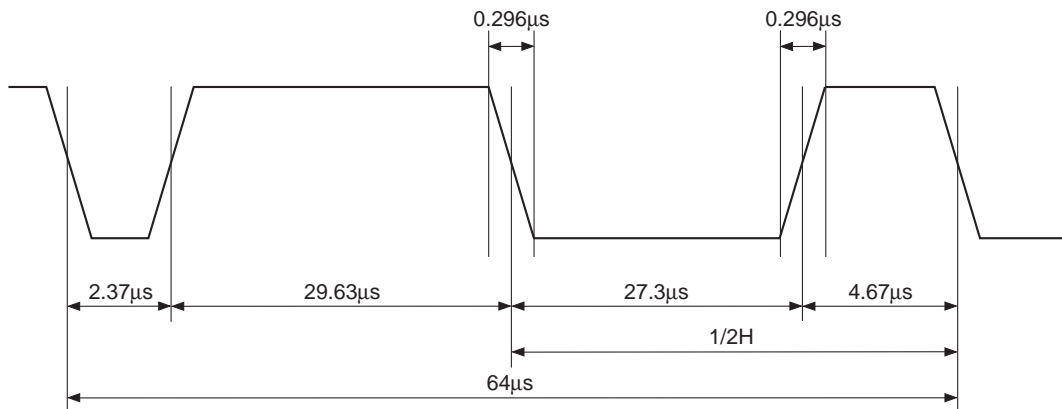

PAL Equalizing Pulse and Sync Pulse Signal Waveform



BIT

Function Selection #2

	7	6	5	4	3	2	1	0	
Address 01H	/	DAC MODE		PIF MODE	PIX TIM		INTERLS	FREE RUN	R/W

- FREERUN**      Free running

0: Reset applied every 4 fields during NTSC or every 8 fields during PAL and MPAL (Default)

1: No SCH timing reset
  
- INTERLS**      Interlace mode switching

0: Non-interlace mode

1: Interlace mode (Default)
  
- PIX TIM**      Pixel input timing

00: #0 (Default)

01: #1

10: #2

11: #3
  
- PIF MODE**      Pixel input format

0: 8-bit mode, multiplexed Y, Cb, Cr (4:2:2) (Default)

1: 16-bit mode, Y and multiplexed Cb, Cr (4:2:2)
  
- DAC MODE**      DAC output activity

00: Non-active

01: CP-Out active

10: Inhibit

11: Video signal (Y, C, CP) -Out active (Default)

BIT

Function Selection #3

	7	6	5	4	3	2	1	0	
Address 02H	CBAR	OSDEN	Y_LEV		VBID	WSS	CC Mode		R/W

- CC MODE      Closed caption encoding mode

  - 00: Disable closed caption encoding (Default)
  - 01: Enable encoding in 1st field (Line 21)
  - 10: Enable encoding in 2nd field (Line 284)
  - 11: Enable encoding in both fields
  
- WSS            WSS encoding enable

  - 0: Disable WSS encoding (Default)
  - 1: Enable WSS encoding
  
- VBID            VBID encoding mode

  - 0: Disable VBID encoding (Default)
  - 1: Enable VBID encoding
  
- Y\_LEV          OSD luminance level select

  - 00: 100% (Default)
  - 01: 25%
  - 10: 50%
  - 11: 75%
  
- OSDEN          OSD enable

  - 0: Disable OSD (Default)
  - 1: Enable OSD
  
- CBAR            Color bar enable

  - 0: Disable on-chip color bar output (Default)
  - 1: Enable on-chip color bar output (ITU\_R100% color bar)

BIT

Function Selection #4

	7	6	5	4	3	2	1	0	
Address 03H	SSEL	BF	CCRST	RGB_CP	D1 MODE	RGB_UV	GSYNC	BTCM	R/W
BTCM	UV output level control 0: SMPTE 1: BetaCam (Default)								
GSYNC	G-on SYNC enable 0: Disable (Default) 1: Enable								
RGB_UV	RGB/YUV output mode switching 0: YUV (Default) 1: RGB								
D1 MODE	ITU-R656 EAV decoding 0: Disable ITU-R656 EAV decoding (Default) 1: Enable ITU-R656 EAV decoding								
RGB_CP	RGB/YCCP output mode switching 0: YCCP (Default) 1: RGB/YUV								
CCRST	Closed caption character reset enable 0: Disable (Default) 1: Enable								
BF	Burst flag enable 0: Disable burst flag 1: Enable burst flag (Default)								
SSEL	Sync select Selects the sync signal used during slave mode. HSYNC VSYNC FID 0: Used Used Ignored (Default) 1: Used Ignored Used								

BIT

**Closed Caption Character #1 (Line 21H)**

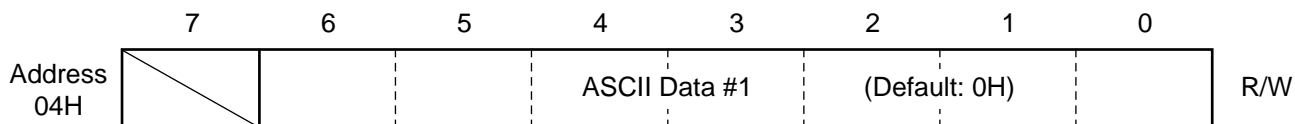

**Closed Caption Character #2 (Line 21H)**

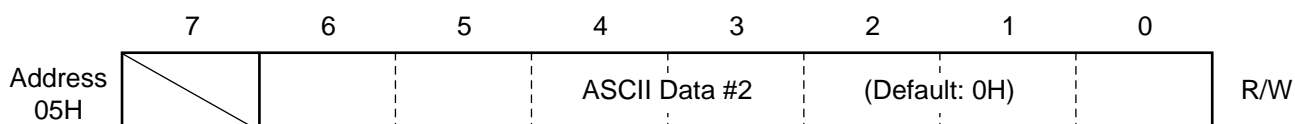

**Closed Caption Character #1 (Line 284H)**

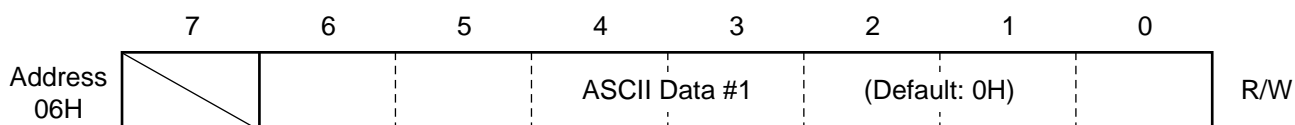

**Closed Caption Character #2 (Line 284H)**

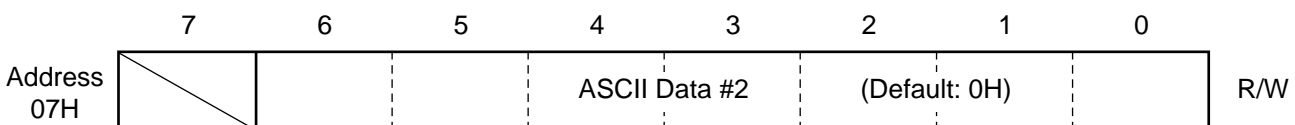

**VBID #1**

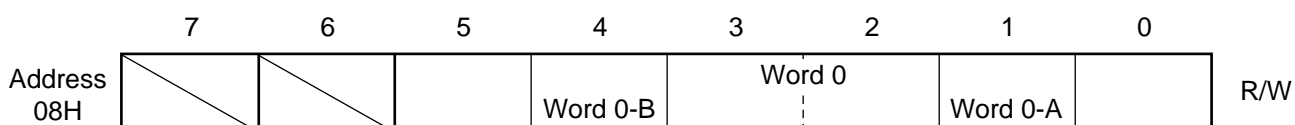

**VBID #2**

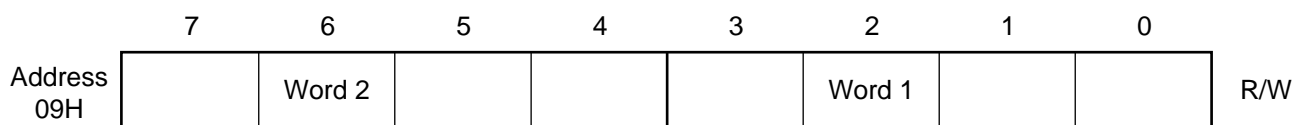

**WSS #1**

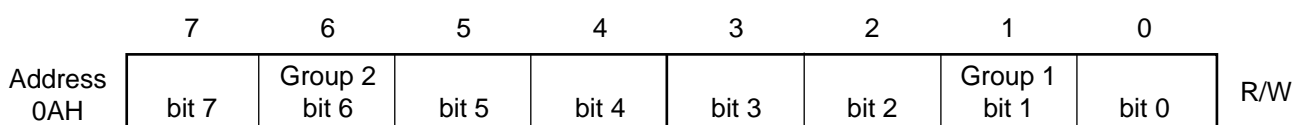

**WSS #2**

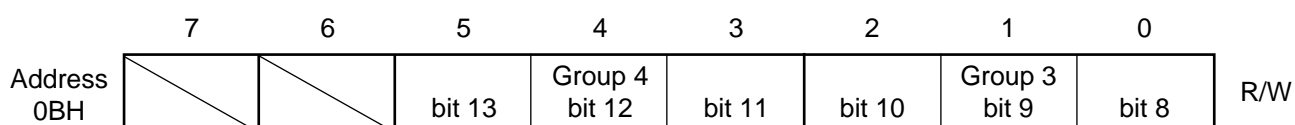



**BIT**

**Device ID #1**

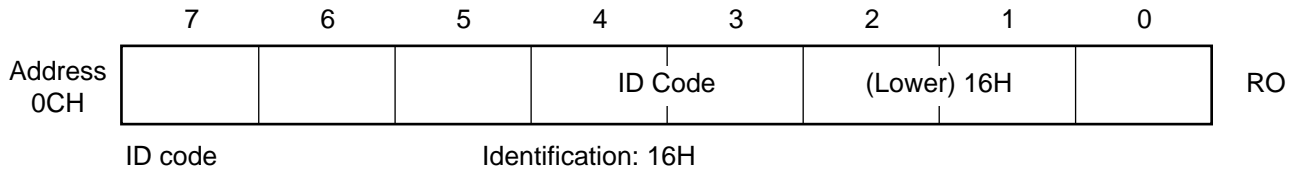

**Device ID #2**

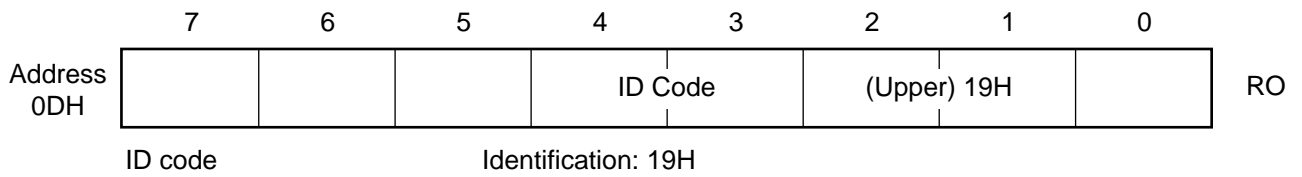

Video Signal Timing (NTSC, 7.5 IRE Setup)

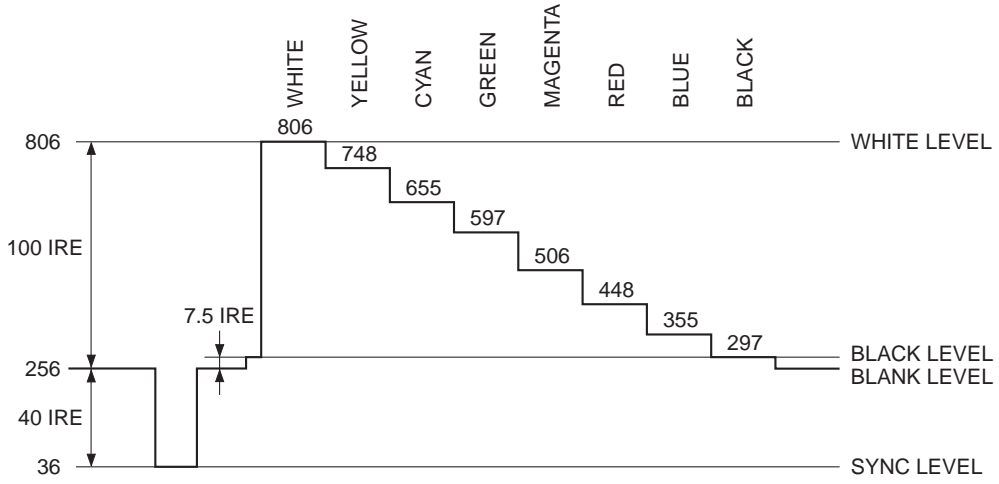

NTSC Y (luminance) signal output waveform  
7.5 IRE setup

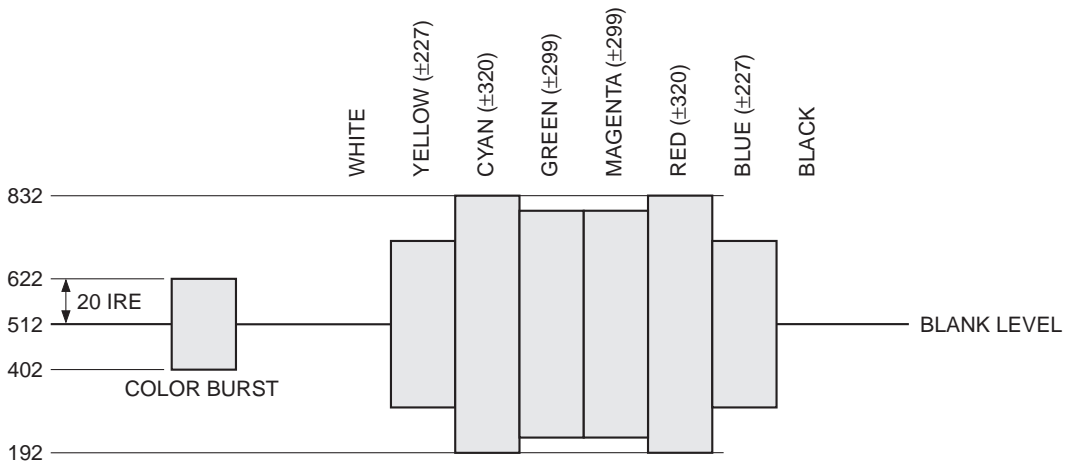

NTSC C (chroma) signal output waveform  
7.5 IRE setup

Video Signal Timing (NTSC, No Setup)

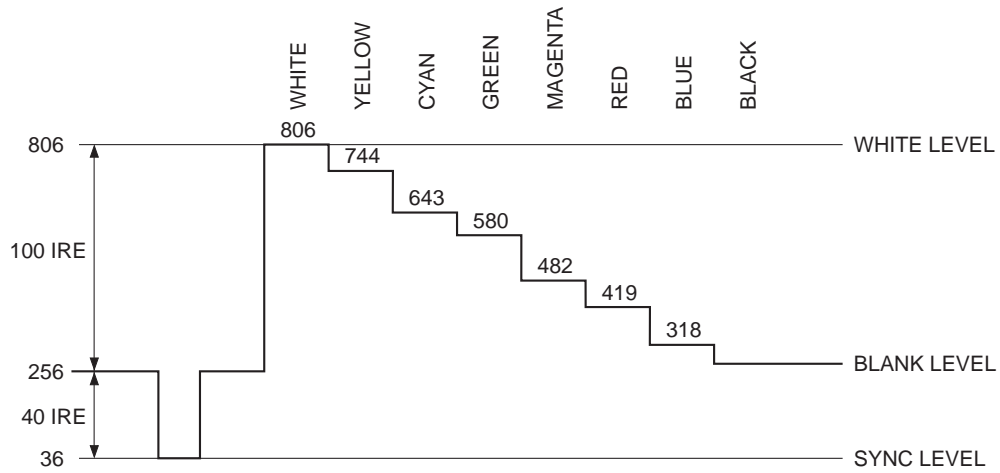

NTSC Y (luminance) signal output waveform

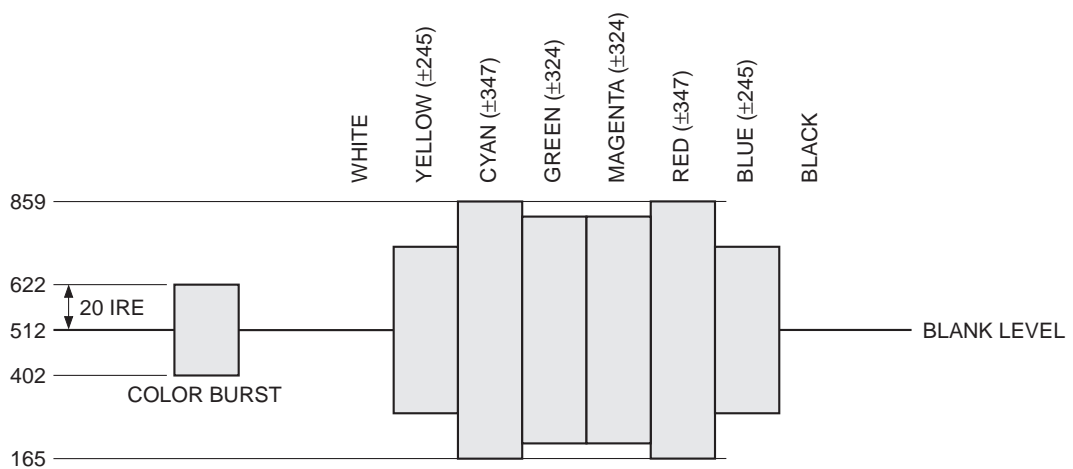

NTSC C (chroma) signal output waveform

Video Signal Timing (PAL)

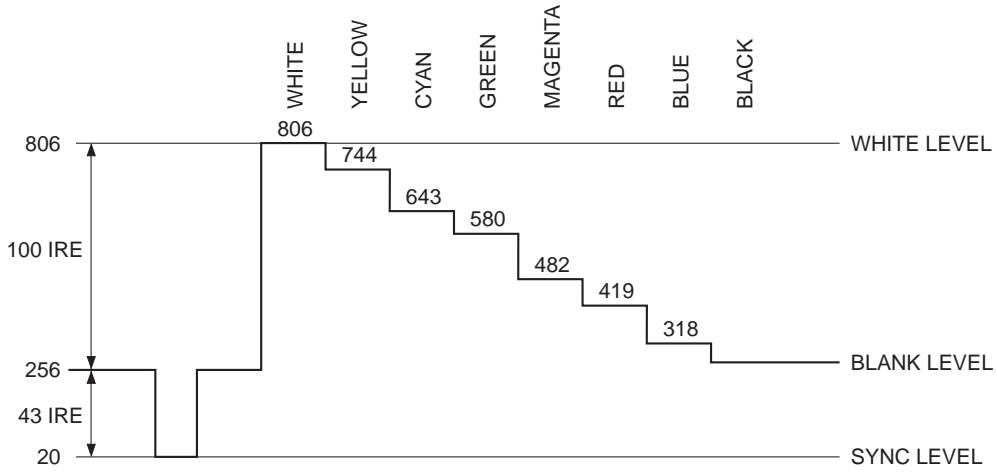

PAL Y (luminance) signal output waveform

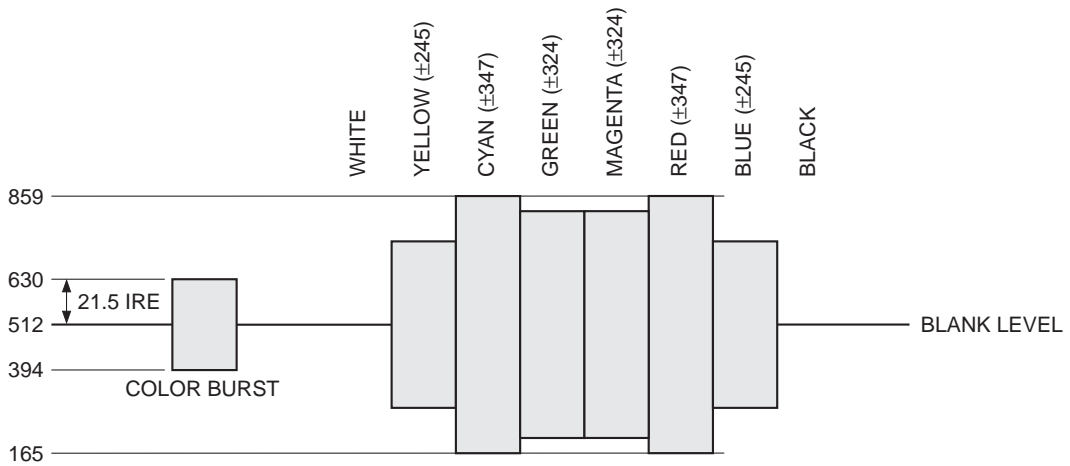

PAL C (chroma) signal output waveform

RGB Signal Output Waveform

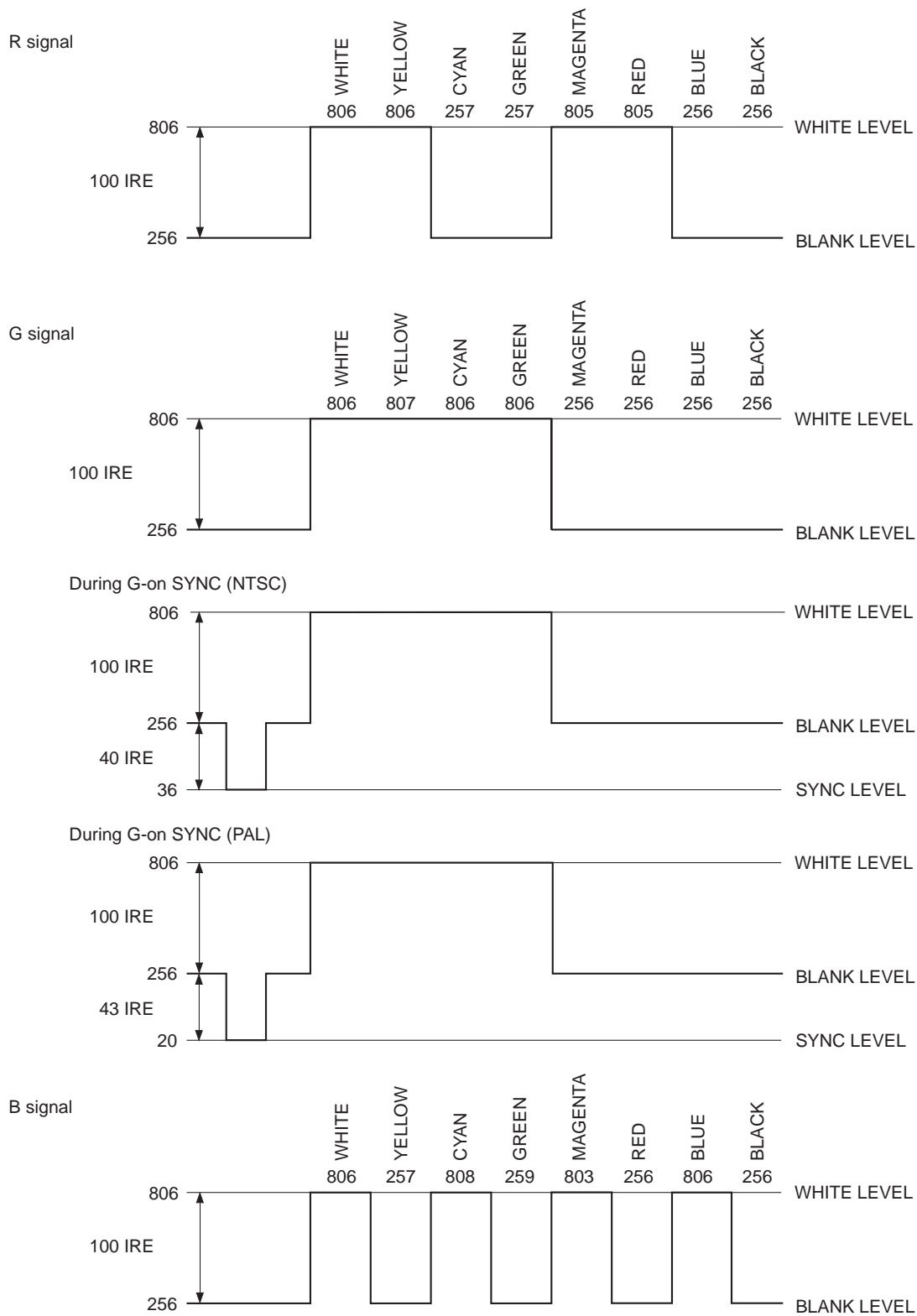

**UV Output Level**  
**Color Difference (U) Signal**

SMPTE LEVEL

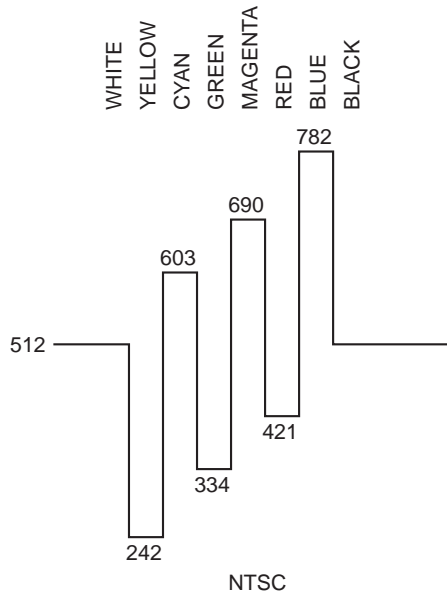

Beta Cam LEVEL

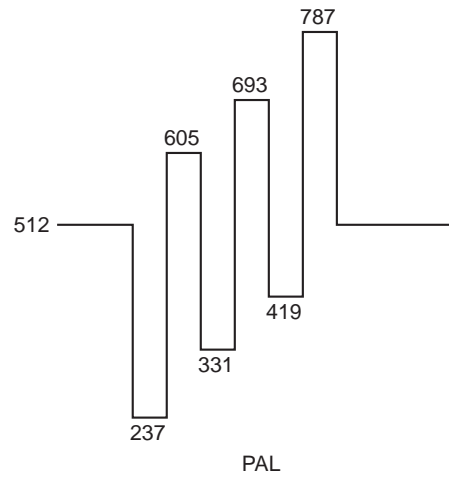
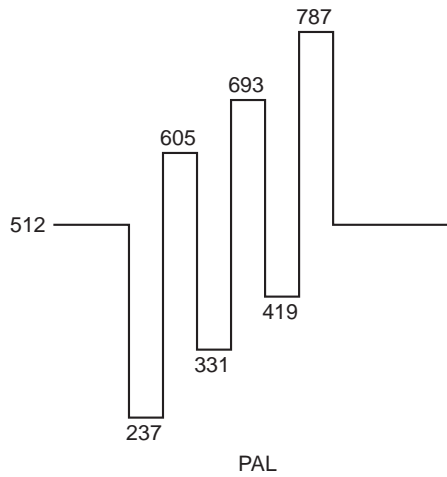
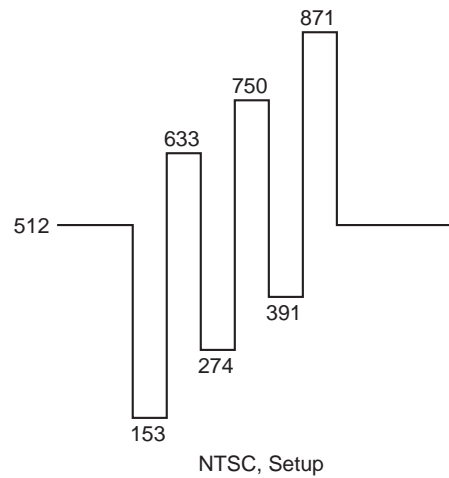
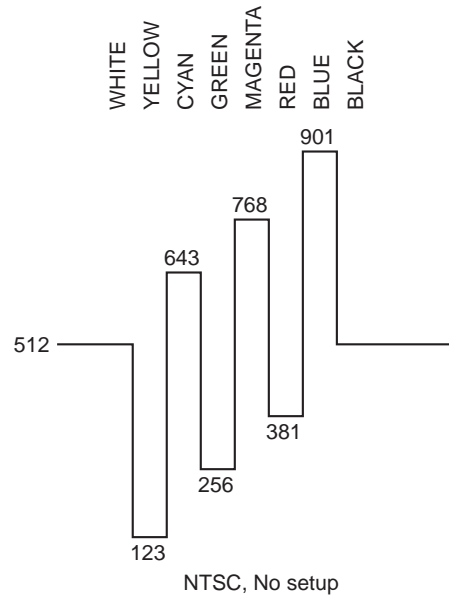

Color Difference (V) Signal

SMPTE LEVEL

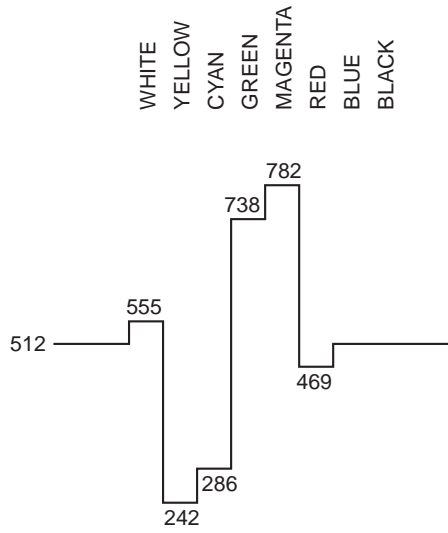

NTSC

Beta Cam LEVEL

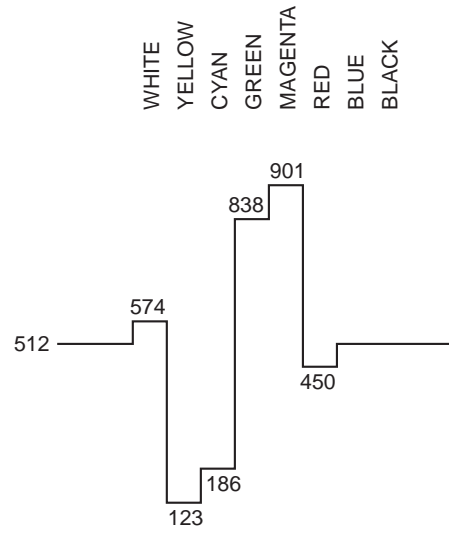

NTSC, No setup

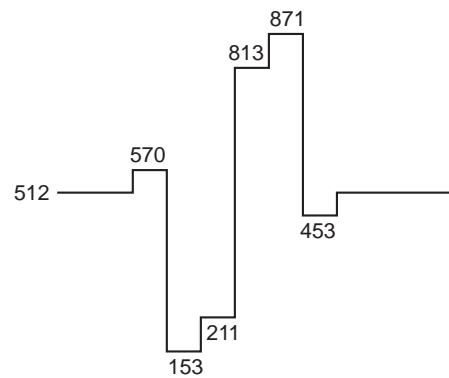

NTSC, Setup

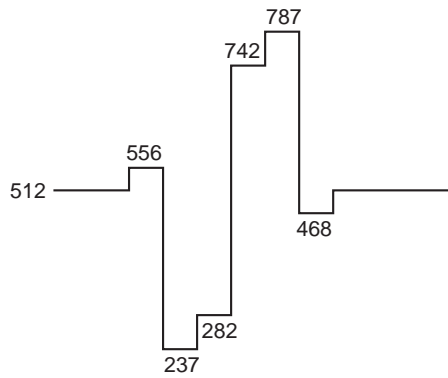

PAL

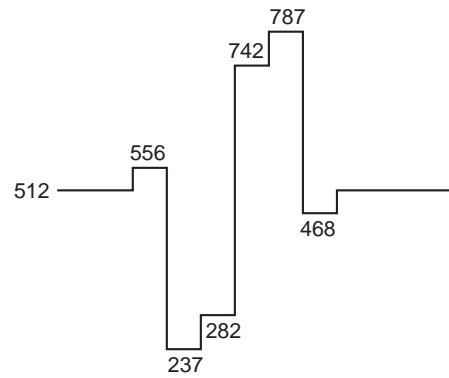

PAL

Internal Filter Characteristics

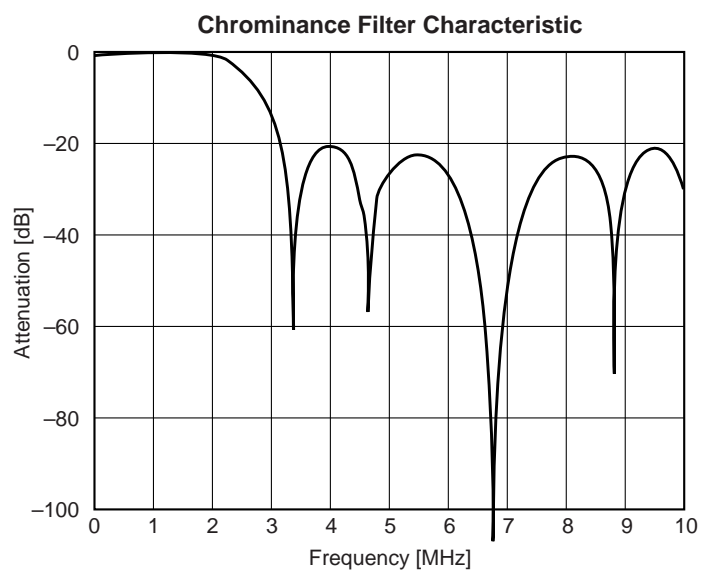
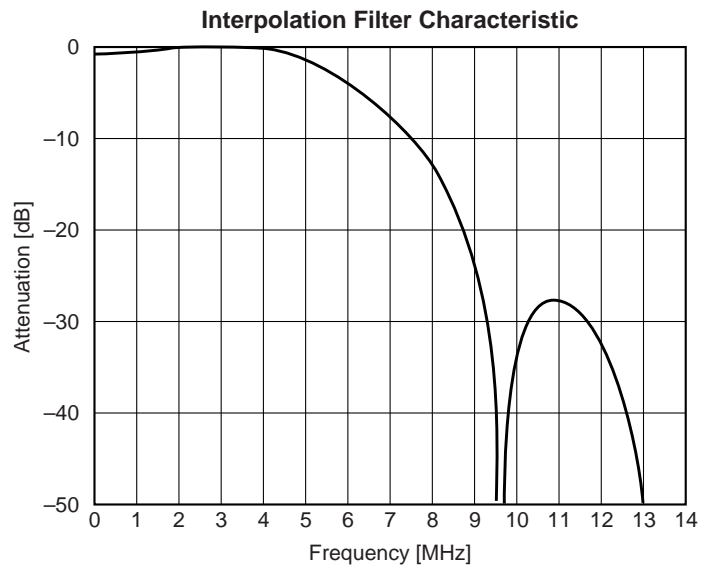



DAC Application Circuit

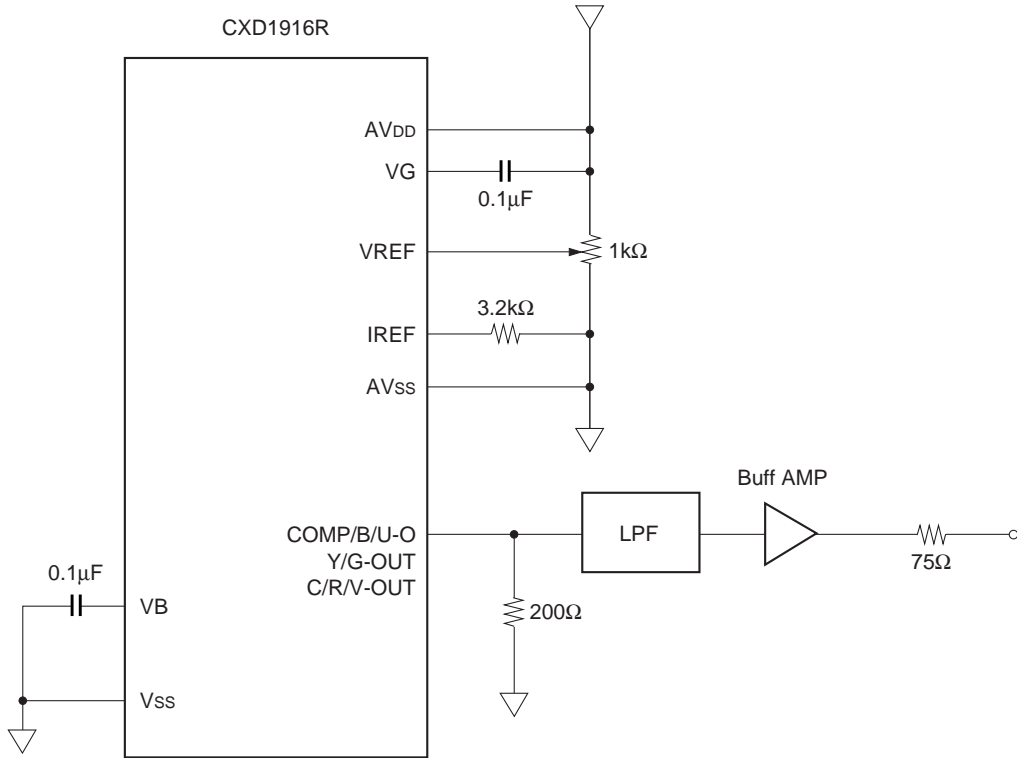

Application Circuit

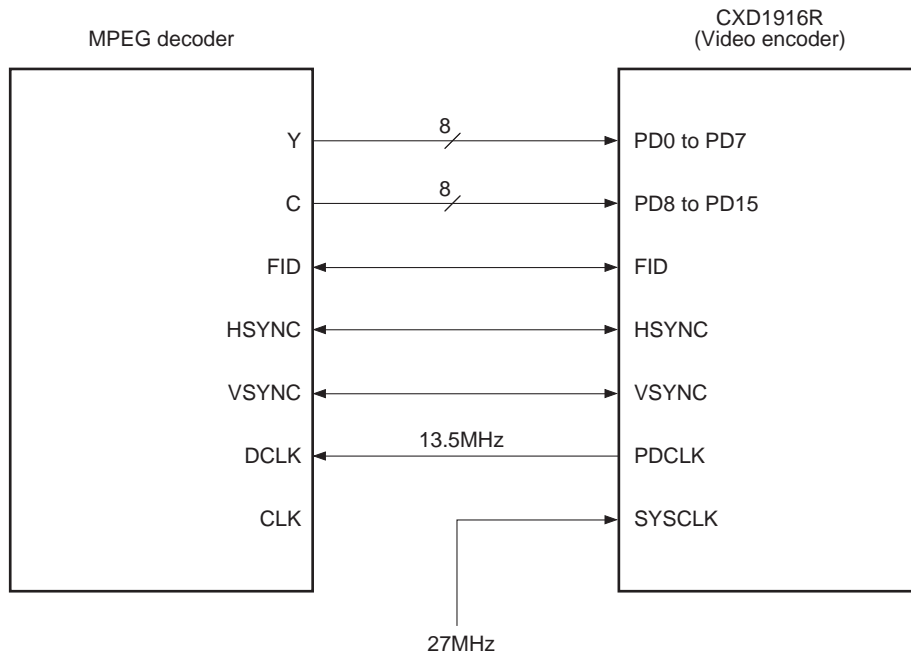

Application circuits shown are typical examples illustrating the operation of the devices. Sony cannot assume responsibility for any problems arising out of the use of these circuits or for any infringement of third party patent and other right due to same.

Package Outline Unit: mm

80PIN LQFP (PLASTIC)

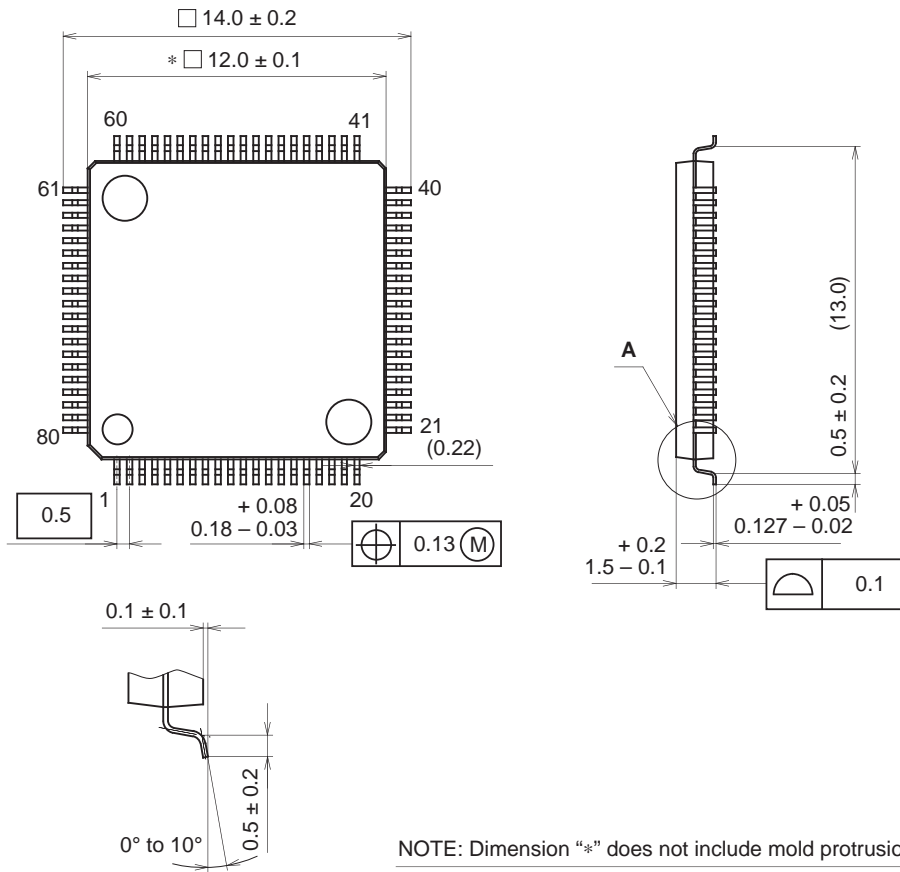

NOTE: Dimension "\*" does not include mold protrusion.

DETAIL A

PACKAGE STRUCTURE

SONY CODE	LQFP-80P-L01
EIAJ CODE	LQFP080-P-1212
JEDEC CODE	_____

PACKAGE MATERIAL	EPOXY RESIN
LEAD TREATMENT	SOLDER PLATING
LEAD MATERIAL	42 ALLOY
PACKAGE MASS	0.5g