

SONY

CXD2470R

Timing Generator for Frame Readout CCD Image Sensor

Description

The CXD2470R is a timing generator IC which generates the timing pulses for performing frame readout using the ICX224, ICX284, ICX202 and ICX232 CCD image sensor.

Features

- Base oscillation frequency 24.00 to 36.00MHz (max.)
- High-speed/low-speed shutter function
- Supports quadruple-speed readout drive
- Horizontal driver for CCD image sensor
- Vertical driver for CCD image sensor

Applications

Digital still cameras

Structure

Silicon gate CMOS IC

Applicable CCD Image Sensors

- ICX224 (Type 1/2, 2020K pixels)
- ICX284 (Type 1/2.7, 2020K pixels)
- ICX202 (Type 1/3, 1250K pixels)
- ICX232 (Type 1/3.6, 1250K pixels)

Pin Configuration

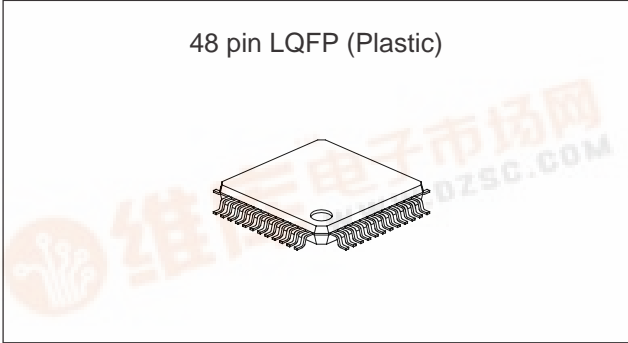
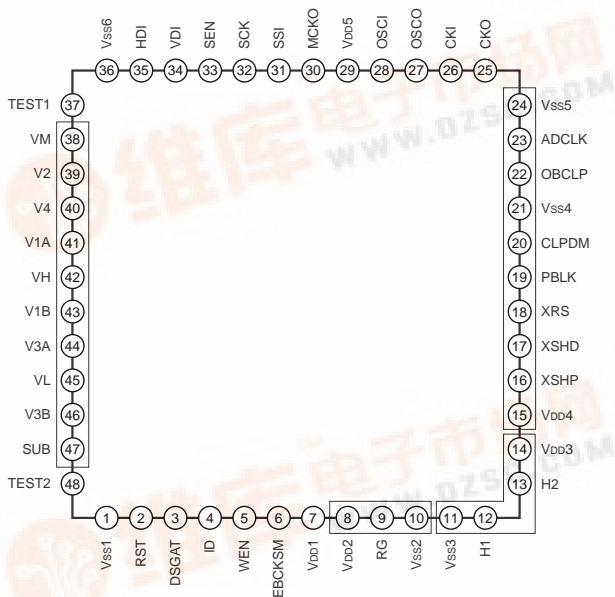

Absolute Maximum Ratings

- Supply voltage

V _{DD}	V _{SS} - 0.3 to +7.0	V
V _L	-10.0 to V _{SS}	V
V _H	V _L - 0.3 to +26.0	V
- Input voltage

V _I	V _{SS} - 0.3 to V _{DD} + 0.3	V
----------------	--	---
- Output voltage

V _{O1}	V _{SS} - 0.3 to V _{DD} + 0.3	V
V _{O2}	V _L - 0.3 to V _{SS} + 0.3	V
V _{O3}	V _L - 0.3 to V _H + 0.3	V
- Operating temperature

T _{opr}	-20 to +75	°C
------------------	------------	----
- Storage temperature

T _{stg}	-55 to +150	°C
------------------	-------------	----

Recommended Operating Conditions

- Supply voltage

V _{DDb}	3.0 to 5.5	V
V _{DDA} , V _{DDC} , V _{DDd}	3.0 to 3.6	V
V _M	0.0	V
V _H	14.5 to 15.5	V
V _L	-7.0 to -8.0	V
- Operating temperature

T _{opr}	-20 to +75	°C
------------------	------------	----

* Groups of pins enclosed in the figure indicate sections for which power supply separation is possible.

Sony reserves the right to change products and specifications without prior notice. This information does not convey any license by any implication or otherwise under any patents or other right. Application circuits shown, if any, are typical examples illustrating the operation of the devices. Sony cannot assume responsibility for any problems arising out of the use of these circuits.



Block Diagram

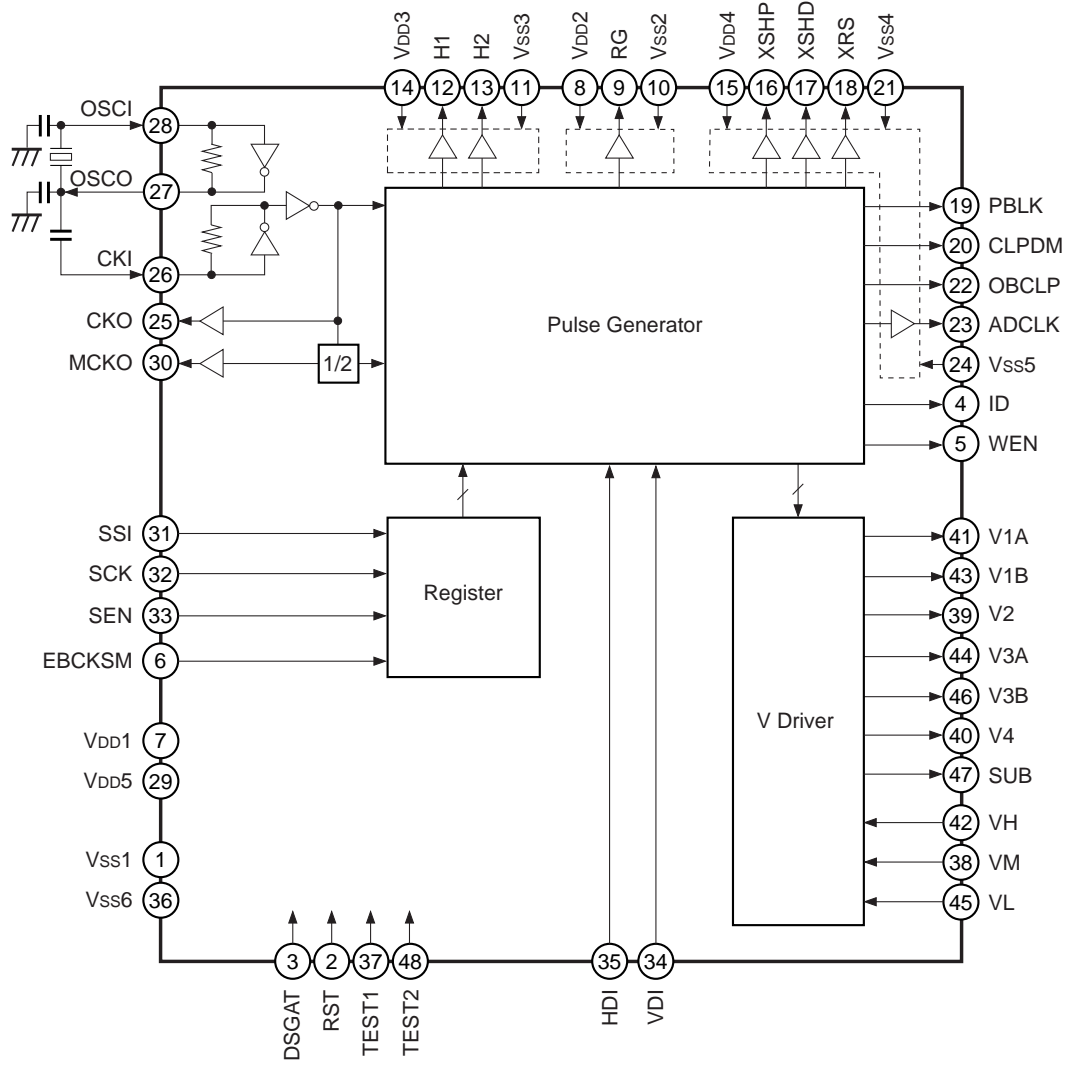

Pin Description

Pin No.	Symbol	I/O	Description
1	Vss1	—	GND
2	RST	I	Internal system reset input. High: Normal operation, Low: Reset control Normally apply reset during power-on. Schmitt trigger input/No protective diode on power supply side
3	DSGAT	I	Control input used to stop pulse generation. High: Normal operation, Low: Stop control Schmitt trigger input/No protective diode on power supply side
4	ID	O	Vertical direction line identification pulse output.
5	WEN	O	Memory write timing pulse output.
6	EBCKSM	I	CHKSUM enable. High: Sum check invalid, Low: Sum check valid With pull-down resistor
7	VDD1	—	3.3V power supply. (Power supply for common logic block)
8	VDD2	—	3.3V power supply. (Power supply for RG)
9	RG	O	CCD reset gate pulse output.
10	Vss2	—	GND
11	Vss3	—	GND
12	H1	O	CCD horizontal register clock output.
13	H2	O	CCD horizontal register clock output.
14	VDD3	—	3.3 to 5.0V power supply. (Power supply for H1/H2)
15	VDD4	—	3.3V power supply. (Power supply for CDS block)
16	XSHP	O	CCD precharge level sample-and-hold pulse output.
17	XSHD	O	CCD data level sample-and-hold pulse output.
18	XRS	O	Sample-and-hold pulse output for analog/digital conversion phase alignment.
19	PBLK	O	Pulse output for horizontal and vertical blanking period pulse cleaning.
20	CLPDM	O	CCD dummy signal clamp pulse output.
21	Vss4	—	GND
22	OBCLP	O	CCD optical black signal clamp pulse output.
23	ADCLK	O	Clock output for analog/digital conversion IC. Logical phase adjustment possible using the serial interface data.
24	Vss5	—	GND
25	CKO	O	Inverter output.
26	CKI	I	Inverter input.
27	OSCO	O	Inverter output for oscillation. When not used, leave open or connect a capacitor.
28	OSCI	I	Inverter input for oscillation. When not used, fix low.
29	VDD5	—	3.3V power supply. (Power supply for common logic block)
30	MCKO	O	System clock output for signal processing IC.

Pin No.	Symbol	I/O	Description
31	SSI	I	Serial interface data input for internal mode settings. Schmitt trigger input/No protective diode on power supply side
32	SCK	I	Serial interface clock input for internal mode settings. Schmitt trigger input/No protective diode on power supply side
33	SEN	I	Serial interface strobe input for internal mode settings. Schmitt trigger input/No protective diode on power supply side
34	VDI	I	Vertical sync signal input. Schmitt trigger input
35	HDI	I	Horizontal sync signal input. Schmitt trigger input
36	Vss6	—	GND
37	TEST1	I	IC test pin 1; normally fixed to GND. With pull-down resistor
38	VM	—	GND (GND for vertical driver)
39	V2	O	CCD vertical register clock output.
40	V4	O	CCD vertical register clock output.
41	V1A	O	CCD vertical register clock output.
42	VH	—	15.0V power supply. (Power supply for vertical driver)
43	V1B	O	CCD vertical register clock output.
44	V3A	O	CCD vertical register clock output.
45	VL	—	-7.5V power supply. (Power supply for vertical driver)
46	V3B	O	CCD vertical register clock output.
47	SUB	O	CCD electronic shutter pulse output.
48	TEST2	I	IC test pin 2; normally fixed to GND. With pull-down resistor

Electrical Characteristics

DC Characteristics

(Within the recommended operating conditions)

Item	Pins	Symbol	Conditions	Min.	Typ.	Max.	Unit
Supply voltage 1	V _{DD2}	V _{DDa}		3.0	3.3	3.6	V
Supply voltage 2	V _{DD3}	V _{DDb}		3.0	3.3	5.5	V
Supply voltage 3	V _{DD4}	V _{DDc}		3.0	3.3	3.6	V
Supply voltage 4	V _{DD1} , V _{DD5}	V _{DDd}		3.0	3.3	3.6	V
Input voltage 1*1	RST, DSGAT, SSI, SCK, SEN, EBCKSM	V _{t+}		0.8V _{DDd}			V
		V _{t-}				0.2V _{DDd}	V
Input voltage 2*2	TEST1, TEST2	V _{IH1}		0.7V _{DDd}			V
		V _{IL1}				0.3V _{DDd}	V
Input voltage 3	VDI, HDI	V _{IH2}		0.7V _{DDd}			V
		V _{IL2}				0.3V _{DDd}	V
Output voltage 1	H1, H2	V _{OH1}	Feed current where I _{OH} = -22.0mA	V _{DDb} - 0.8			V
		V _{OL1}	Pull-in current where I _{OL} = 14.4mA			0.4	V
Output voltage 2	RG	V _{OH2}	Feed current where I _{OH} = -3.3mA	V _{DDb} - 0.8			V
		V _{OL2}	Pull-in current where I _{OL} = 2.4mA			0.4	V
Output voltage 3	XSHP, XSHD, XRS, PBLK, OBCLP, CLPDM, ADCLK	V _{OH3}	Feed current where I _{OH} = -3.3mA	V _{DDc} - 0.8			V
		V _{OL3}	Pull-in current where I _{OL} = 2.4mA			0.4	V
Output voltage 4	CKO, MCKO	V _{OH4}	Feed current where I _{OH} = -10.4mA	V _{DDd} - 0.8			V
		V _{OL4}	Pull-in current where I _{OL} = 7.2mA			0.4	V
Output current 1	V1A, V1B, V3A, V3B, V2, V4	I _{OL}	V1A/B, V2, V3A/B, V4 = -8.25V	10.0			mA
		I _{OM1}	V1A/B, V2, V3A/B, V4 = -0.25V			-5.0	mA
		I _{OM2}	V1A/B, V3A/B = 0.25V	5.0			mA
		I _{OH}	V1A/B, V3A/B = 14.75V			-7.2	mA
Output current 2	SUB	I _{OSL}	SUB = -8.25V	5.4			mA
		I _{OSH}	SUB = 14.75V			-4.0	mA

*1 These input pins are Schmitt trigger inputs and do not have protective diodes on the internal power supply side.

*2 These input pins have internal pull-down resistors.

Note) The above table indicates the condition for 3.3V drive.

Inverter I/O Characteristics for Oscillation

(Within the recommended operating conditions)

Item	Pins	Symbol	Conditions	Min.	Typ.	Max.	Unit
Logical Vth	OSCI	LVth			V _{DDd} /2		V
Input voltage	OSCI	V _{IH}		0.7V _{DDd}			V
		V _{IL}				0.3V _{DDd}	V
Output voltage	OSCO	V _{OH}	Feed current where I _{OH} = -3.6mA	V _{DDd} - 0.8			V
		V _{OL}	Pull-in current where I _{OL} = 2.4mA			0.4	V
Feedback resistor	OSCI, OSCO	RFB	V _{IN} = V _{DDd} or V _{SS}	500k	2M	5M	Ω
Oscillation frequency	OSCI, OSCO	f		20		50	MHz

Inverter Input Characteristics for Base Oscillation Clock Duty Adjustment

(Within the recommended operating conditions)

Item	Pins	Symbol	Conditions	Min.	Typ.	Max.	Unit
Logical Vth	CKI	LVth			V _{DDd} /2		V
Input voltage		V _{IH}		0.7V _{DDd}			V
		V _{IL}				0.3V _{DDd}	V
Input amplitude		V _{IN}	f _{max} 50MHz sine wave	0.3			V _{p-p}

Note) Input voltage is the input voltage characteristics for direct input from an external source. Input amplitude is the input amplitude characteristics in the case of input through a capacitor.

Switching Characteristics

(V_H = 15.0V, V_M = GND, V_L = -7.5V)

Item	Symbol	Conditions	Min.	Typ.	Max.	Unit
Rise time	TTLM	V _L to V _M	200	350	500	ns
	TTMH	V _M to V _H	200	350	500	ns
	TTLH	V _L to V _H	30	60	90	ns
Fall time	TTML	V _M to V _L	200	350	500	ns
	TTHM	V _H to V _M	200	350	500	ns
	TTHL	V _H to V _L	30	60	90	ns
Output noise voltage	VCLH				1.0	V
	VCLL				1.0	V
	VCMH				1.0	V
	VCML				1.0	V

- Notes)**
1. The MOS structure of this IC has a low tolerance for static electricity, so full care should be given for measures to prevent electrostatic discharge.
 2. For noise and latch-up countermeasures, be sure to connect a by-pass capacitor (0.1μF or more) between each power supply pin (V_H, V_L) and GND.
 3. To protect the CCD image sensor, clamp the SUB pin output at V_H before input to the CCD image sensor.

Switching Waveforms

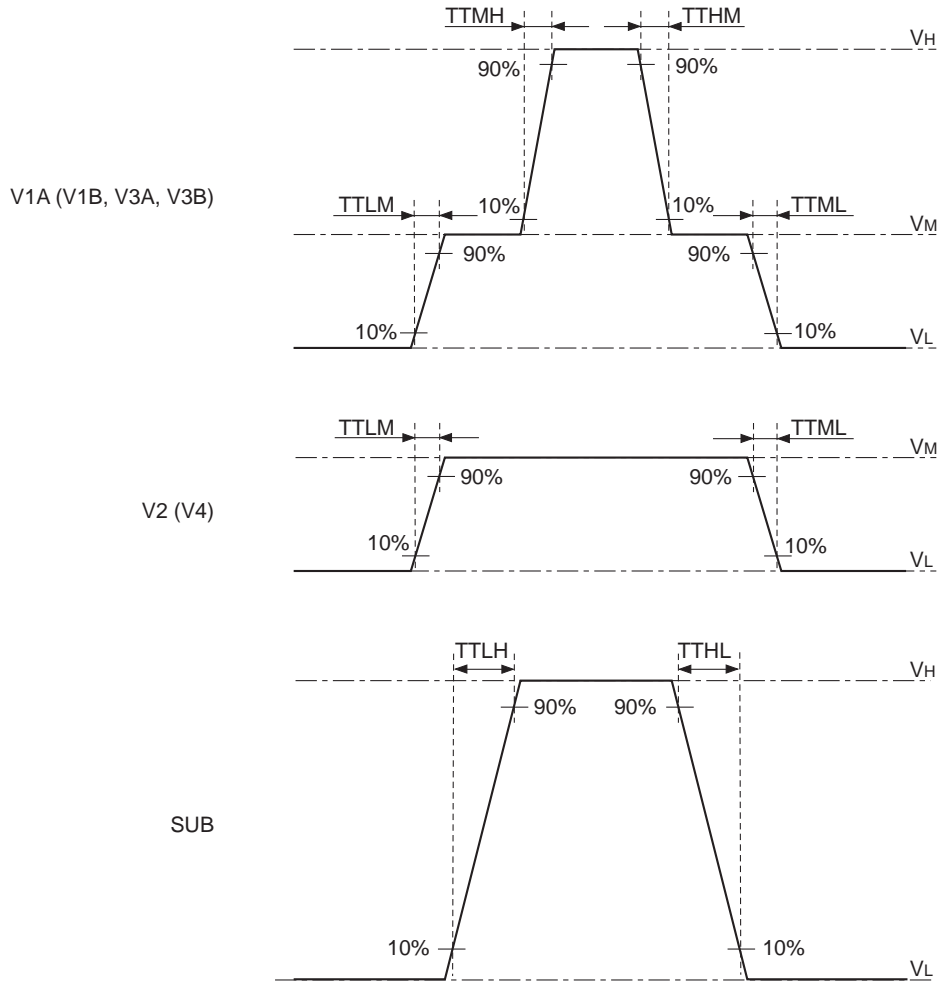

Waveform Noise

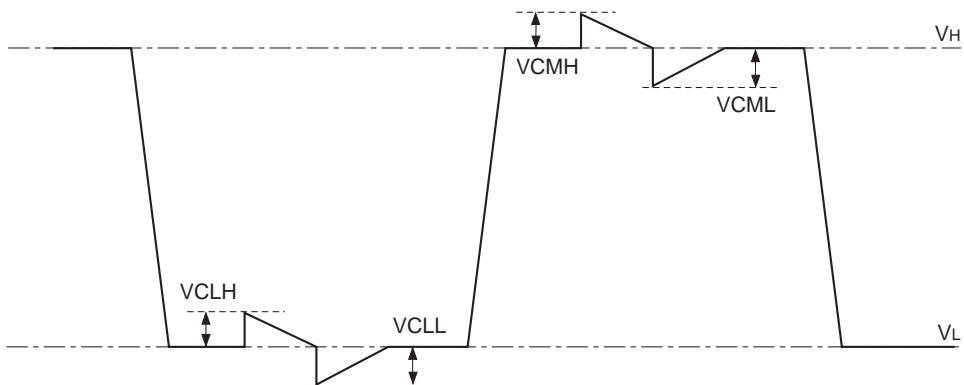

Measurement Circuit

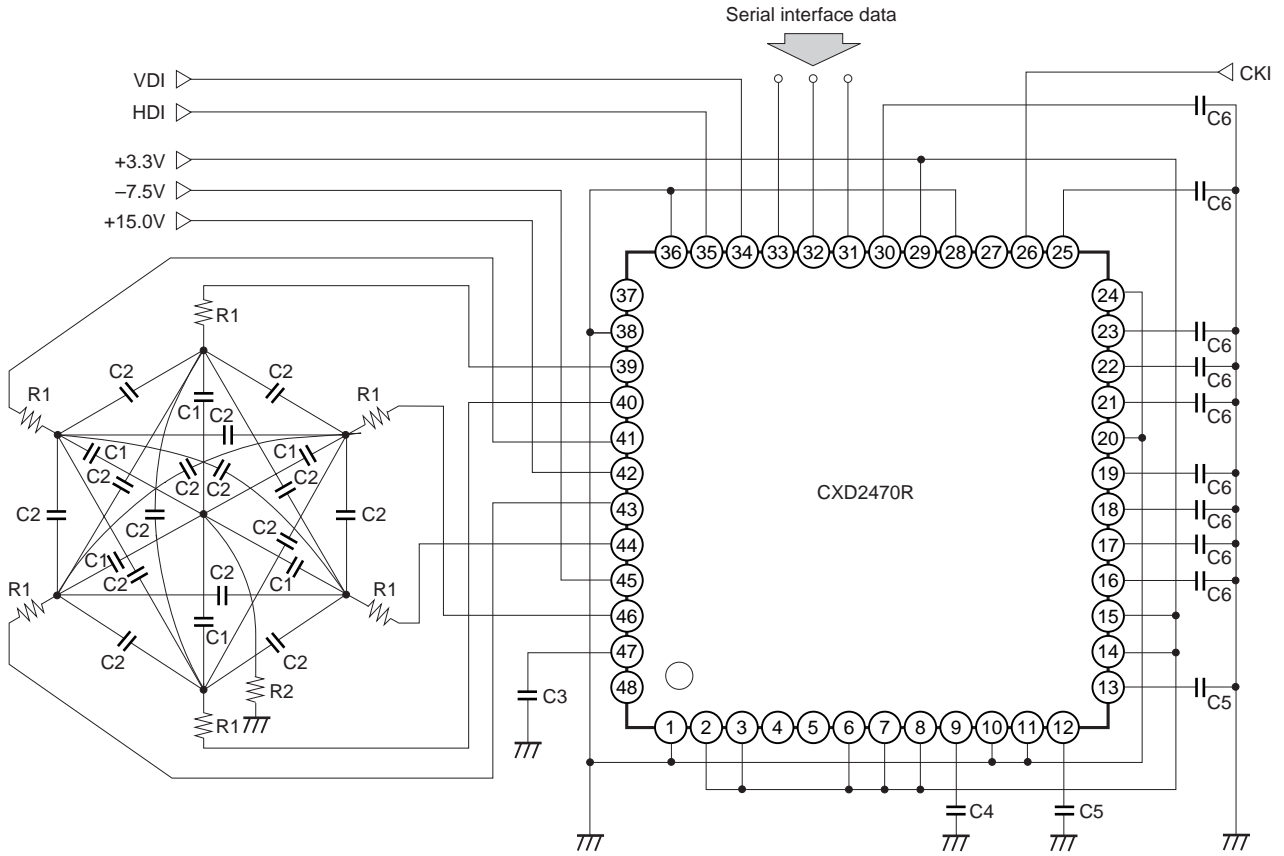

C1	3300pF	C2	560pF	C3	820pF	C4	30pF	C5	180pF	C6	10pF
R1	30Ω	R2	10Ω								

AC Characteristics

AC characteristics between the serial interface clocks

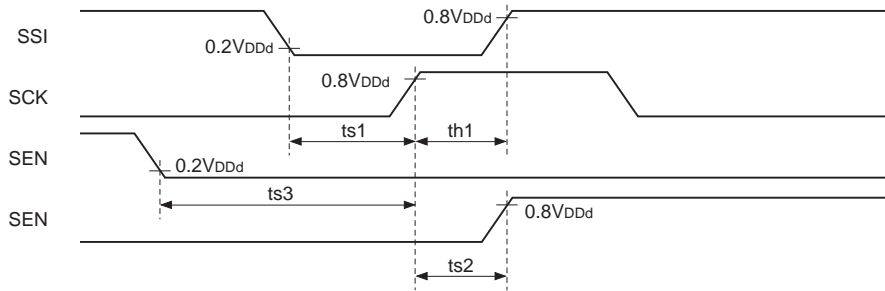

(Within the recommended operating conditions)

Symbol	Definition	Min.	Typ.	Max.	Unit
ts1	SSI setup time, activated by the rising edge of SCK	20			ns
th1	SSI hold time, activated by the rising edge of SCK	20			ns
ts2	SCK setup time, activated by the rising edge of SEN	80			ns
ts3	SEN setup time, activated by the rising edge of SCK	20			ns

Serial interface clock internal loading characteristics (1)

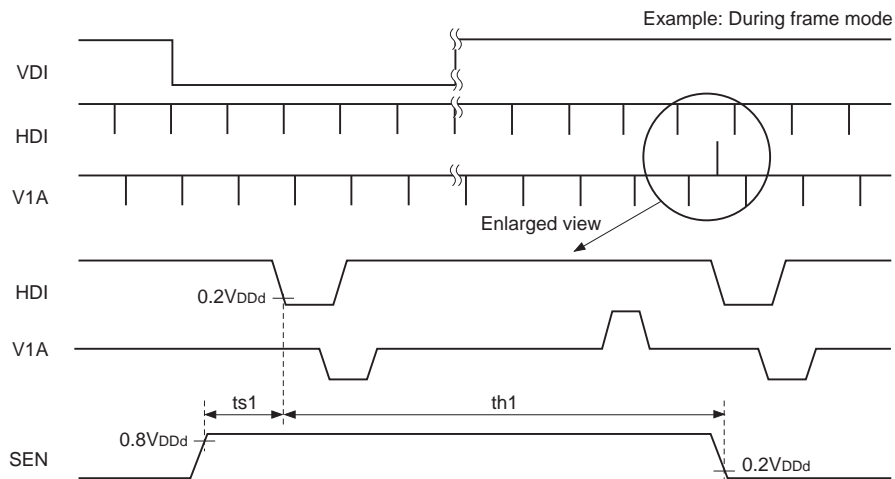

* Be sure to maintain a constantly high SEN logic level near the falling edge of the HDI in the horizontal period during which V1A/B and V3A/B values take the ternary value and during that horizontal period.

(Within the recommended operating conditions)

Symbol	Definition	Min.	Typ.	Max.	Unit
ts1	SEN setup time, activated by the falling edge of HDI	0			ns
th1	SEN hold time, activated by the falling edge of HDI	102			μs

Serial interface clock internal loading characteristics (2)

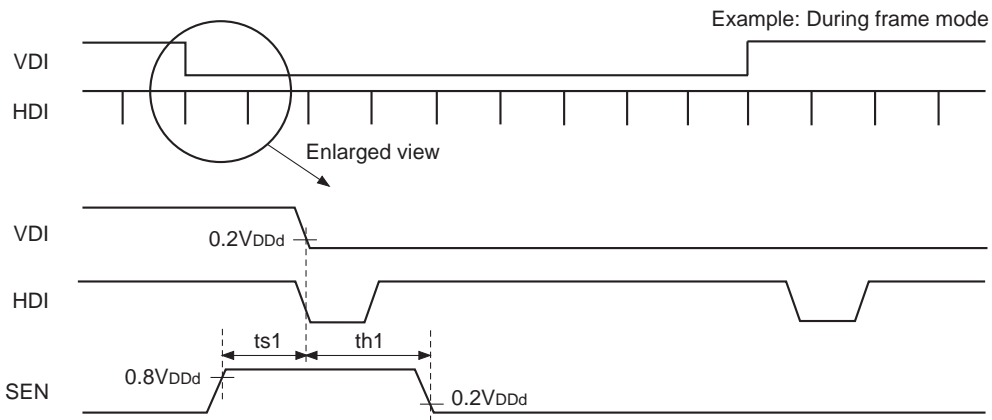

* Be sure to maintain a constantly high SEN logic level near the falling edge of VDI.

(Within the recommended operating conditions)

Symbol	Definition	Min.	Typ.	Max.	Unit
ts1	SEN setup time, activated by the falling edge of VDI	0			ns
th1	SEN hold time, activated by the falling edge of VDI	200			ns

Serial interface clock output variation characteristics

Normally, the serial interface data is loaded to the CXD2470R at the timing shown in "Serial interface clock internal loading characteristics (1)" above. However, one exception to this is when the data such as STB is loaded to the CXD2470R and controlled at the rising edge of SEN. See "Description of Operation".

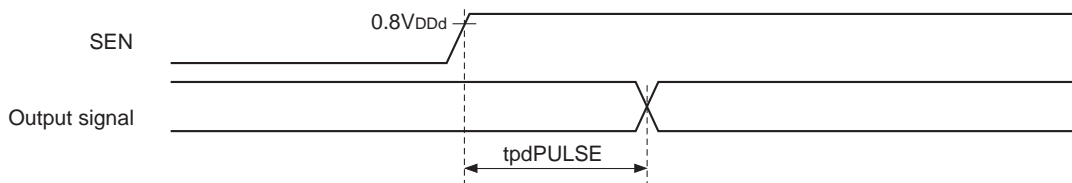

(Within the recommended operating conditions)

Symbol	Definition	Min.	Typ.	Max.	Unit
tpdPULSE	Output signal delay, activated by the rising edge of SEN	5		100	ns

RST loading characteristics

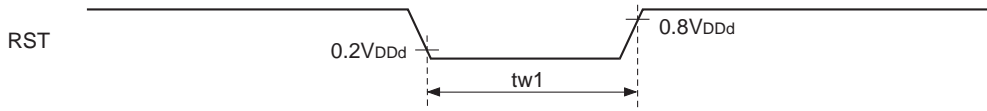

(Within the recommended operating conditions)

Symbol	Definition	Min.	Typ.	Max.	Unit
tw1	RST pulse width	35			ns

VDI and HDI loading characteristics

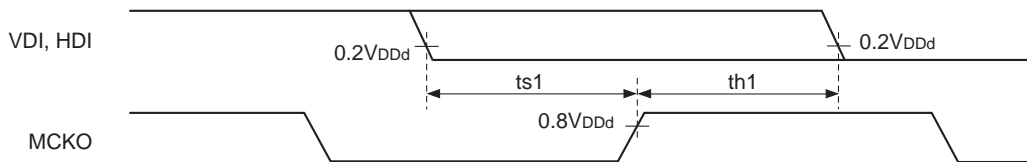

MCKO load capacitance = 10pF*1

(Within the recommended operating conditions)

Symbol	Definition	Min.	Typ.	Max.	Unit
ts1	VDI and HDI setup time, activated by the rising edge of MCKO	20			ns
th1	VDI and HDI hold time, activated by the rising edge of MCKO	5			ns

Output timing characteristics using DSGAT

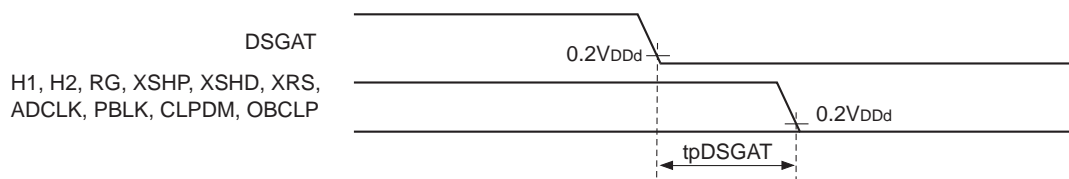

H1 and H2 load capacitance = 180pF, RG load capacitance = 30pF,
 XSHP, XSHD, XRS, PBLK, CLPDM, OBCLP and ADCLK load capacitance = 10pF

(Within the recommended operating conditions)

Symbol	Definition	Min.	Typ.	Max.	Unit
tpDSGAT	Time until the above outputs go low after the fall of DSGAT			100	ns

Output variation characteristics

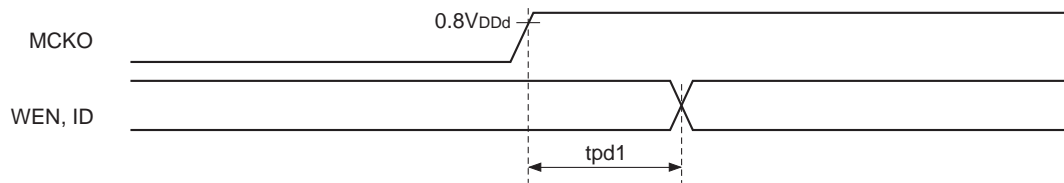

WEN and ID load capacitance = 10pF

(Within the recommended operating conditions)

Symbol	Definition	Min.	Typ.	Max.	Unit
tpd1	Time until the above outputs change after the rise of MCKO	20		60	ns

Description of Operation

Pulses output from the CXD2470R are controlled mainly by the **RST** and **DSGAT** pins and by the serial interface data. The Pin Status Table is shown below, and the details of serial interface control are described on the following pages.

Pin Status Table

Pin No.	Symbol	CAM	SLP	STB	DSGAT	RST	Pin No.	Symbol	CAM	SLP	STB	DSGAT	RST	
1	Vss1	—						25	CKO	ACT	ACT	L	ACT	ACT
2	RST	ACT	ACT	ACT	ACT	L	26	CKI	ACT	ACT	ACT	ACT	ACT	
3	DSGAT	ACT	ACT	ACT	L	ACT	27	OSCO	ACT	ACT	ACT	ACT	ACT	
4	ID	ACT	L	L	ACT	L	28	OSCI	ACT	ACT	ACT	ACT	ACT	
5	WEN	ACT	L	L	ACT	L	29	VDD5	—					
6	EBCKSM	ACT	ACT	ACT	ACT	ACT	30	MCKO	ACT	ACT	L	ACT	ACT	
7	VDD1	—						31	SSI	ACT	ACT	ACT	ACT	DIS
8	VDD2	—						32	SCK	ACT	ACT	ACT	ACT	DIS
9	RG	ACT	L	L	L	ACT	33	SEN	ACT	ACT	ACT	ACT	DIS	
10	Vss2	—						34	VDI	ACT	ACT	ACT	ACT	ACT
11	Vss3	—						35	HDI	ACT	ACT	ACT	ACT	ACT
12	H1	ACT	L	L	L	ACT	36	Vss6	—					
13	H2	ACT	L	L	L	ACT	37	TEST1	—					
14	VDD3	—						38	VM	—				
15	VDD4	—						39	V2	ACT	VM	VM	VM	VM
16	XSHP	ACT	L	L	L	ACT	40	V4	ACT	VM	VM	VM	VL	
17	XSHD	ACT	L	L	L	ACT	41	V1A	ACT	VH	VH	VH	VM	
18	XRS	ACT	L	L	L	ACT	42	VH	—					
19	PBLK	ACT	L	L	L	H	43	V1B	ACT	VH	VH	VH	VM	
20	CLPDM	ACT	L	L	L	H	44	V3A	ACT	VH	VH	VH	VL	
21	Vss4	—						45	VL	—				
22	OBCLP	ACT	L	L	L	H	46	V3B	ACT	VH	VH	VH	VL	
23	ADCLK	ACT	L	L	L	ACT	47	SUB	ACT	VH	VH	VH	VL	
24	Vss5	—						48	TEST2	—				

Note) ACT means that the circuit is operating, and DIS means that loading is stopped.

L indicates a low output level, and H a high output level in the controlled status.

Also, VH, VM and VL indicate the voltage levels applied to VH (Pin 42), VM (Pin 38) and VL (Pin 45), respectively, in the controlled status.

Serial Interface Control

The CXD2470R basically loads and reflects the serial interface data sent in the following format in the readout portion at the falling edge of HDI. Here, readout portion specifies the horizontal period during which V1A/B and V3A/B, etc. take the ternary value.

Note that some items reflect the serial interface data at the falling edge of VDI or the rising edge of SEN.

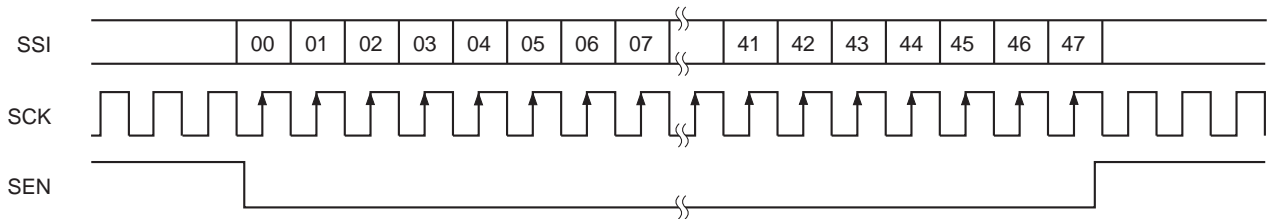

There are two categories of serial interface data: CXD2470R drive control data (hereafter "control data") and electronic shutter data (hereafter "shutter data").

The details of each data are described below.

Control Data

Data	Symbol	Function	Data = 0	Data = 1	RST
D00 to D07	CHIP	Chip enable	10000001 → Enabled Other values → Disabled		All 0
D08 to D09	CTG	Category switching	See [D08] to [D09] CTG.		All 0
D10 to D11	MODE	Drive mode switching	See [D10] to [D11] MODE.		All 0
D12	CCD	CCD switching	ICX224/ICX284	ICX202/ICX232	0
D13 to D14	SMD	Electronic shutter mode switching	See [D13] to [D14] SMD.		All 0
D15 to D35	—	—	—	—	All 0
D36 to D37	LDAD	ADCLK logic phase switching	See [D36] to [D37] LDAD.		1 0
D38 to D39	STB	Standby control	See [D38] to [D39] STB.		All 0
D40 to D47	CKSM	Check sum bit	See [D40] to [D47] CKSM.		All 0

Shutter Data

Data	Symbol	Function	Data = 0	Data = 1	RST
D00 to D07	CHIP	Chip enable	10000001 → Enabled Other values → Disabled		All 0
D08 to D09	CTG	Category switching	See D08 to D09 CTG.		All 0
D10 to D17	SVD	Electronic shutter vertical period specification	See D10 to D17 SVD.		All 0
D18 to D27	SHD	Electronic shutter horizontal period specification	See D18 to D27 SHD.		All 0
D28 to D35	SPL	High-speed shutter position specification	See D28 to D35 SPL.		All 0
D36 to D39	—	—	—	—	All 0
D40 to D47	CKSM	Check sum bit	See D40 to D47 CKSM.		All 0

Control data: D12 CCD [CCD switching]

Specifies CCD image sensor to be used. However, the CCD image sensor switching bit is loaded to the CXD2470R and reflected at the falling edge of VDI. The default is "ICX224/ICX284".

D12	CCD
0	ICX224/ICX284
1	ICX202/ICX232

Control data: D36 to D37 LDAD [ADCLK logic phase adjustment]

This indicates the ADCLK logic phase adjustment data. The default is 90° relative to MCKO.

D37	D36	Degree of adjustment (°)
0	0	0
0	1	90
1	0	180
1	1	270

Control data: D38 to D39 STB [Standby]

The operating mode is switched as follows. However, the standby bits are loaded to the CXD2470R and control is applied immediately at the rising edge of SEN.

D39	D38	Symbol	Operating mode
X	0	CAM	Normal operating mode
0	1	SLP	Sleep mode
1	1	STB	Standby mode

See the Pin Status Table for the pin status in each mode.

Control data/shutter data: [Electronic shutter]

The CXD2470R realizes various electronic shutter functions by using control data [D13] to [D14] SMD and shutter data [D10] to [D17] SVD, [D18] to [D27] SHD and [D28] to [D35] SPL.

These functions are described in detail below.

First, the various modes are shown below.

These modes are switched using control data [D13] to [D14] SMD.

D14	D13	Description of operation
0	0	Electronic shutter stopped mode
0	1	High-speed/low-speed shutter mode
1	0	
1	1	HTSG control mode

The electronic shutter data is expressed as shown in the table below using [D18] to [D27] SHD as an example.

MSB						LSB			
D27	D26	D25	D24	D23	D22	D21	D20	D19	D18
0	1	1	1	0	0	0	0	1	1
	↓			↓				↓	
	1			C				3	

→ SHD is expressed as [1C3h].

[Electronic shutter stopped mode]

During this mode, all shutter data items are invalid.

SUB is not output in this mode, so the shutter speed is the accumulation time for one field.

[High-speed/low-speed shutter mode]

During this mode, the shutter data items have the following meanings.

Symbol	Data	Description
SVD	[D10] to [D17]	Number of vertical periods specification (00h ≤ SVD ≤ FFh)
SHD	[D18] to [D27]	Number of horizontal periods specification (000h ≤ SHD ≤ 3FFh)
SPL	[D28] to [D35]	Vertical period specification for high-speed shutter operation (00h ≤ SPL ≤ FFh)

The period during which SVD and SHD are specified together is the shutter speed. Concretely, when specifying high-speed shutter, SVD is set to "00h". (See the figure.) During low-speed shutter, or in other words when SVD is set to "01h" or higher, the serial interface data is not loaded until this period is finished.

The vertical period indicated here corresponds to one field in each drive mode. In addition, the number of horizontal periods applied to SHD can be considered as (number of SUB pulses – 1).

Note) The bit data definition area is assured in terms of the CXD2470R functions, and does not assure the CCD characteristics.

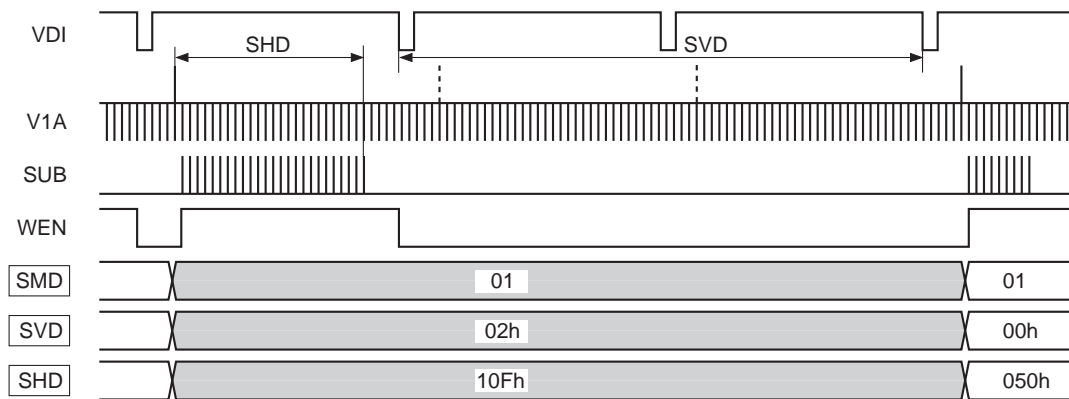

Further, SPL can be used during this mode to specify the SUB output at the desired vertical period during the low-speed shutter period.

In the case below, SUB is output based on SHD at the SPL vertical period out of (SVD + 1) vertical periods.

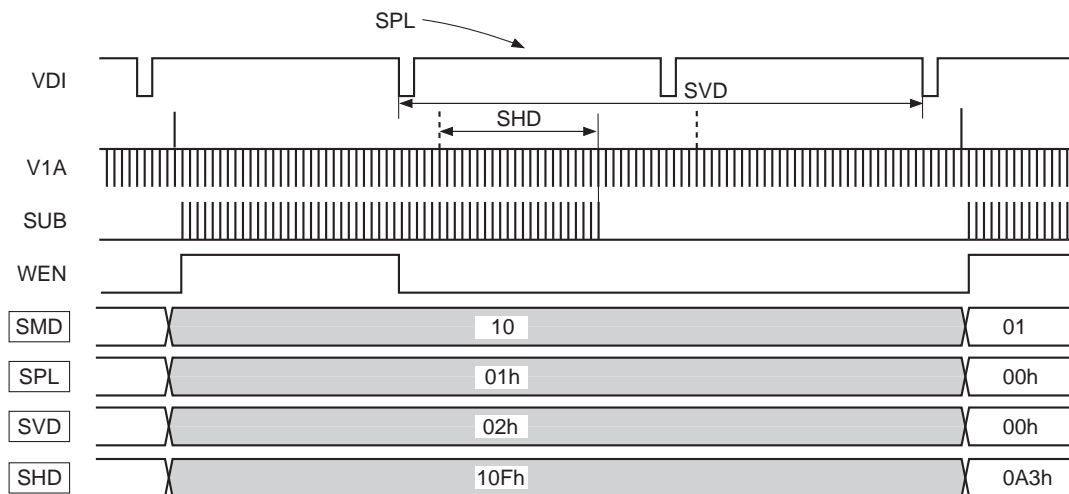

Incidentally, SPL is counted as "00h", "01h", "02h" and so on in conformance with SVD.

Using this function it is possible to achieve smooth exposure time transitions when changing from low-speed shutter to high-speed shutter or vice-versa.

[HTSG control mode]

During this mode, all shutter data items are invalid.

The V1A/B and V3A/B ternary level outputs are stopped, so the shutter speed is the value obtained by adding the shutter speed specified in the preceding vertical period to the vertical period during which these readout pulses are stopped as shown in the figure.

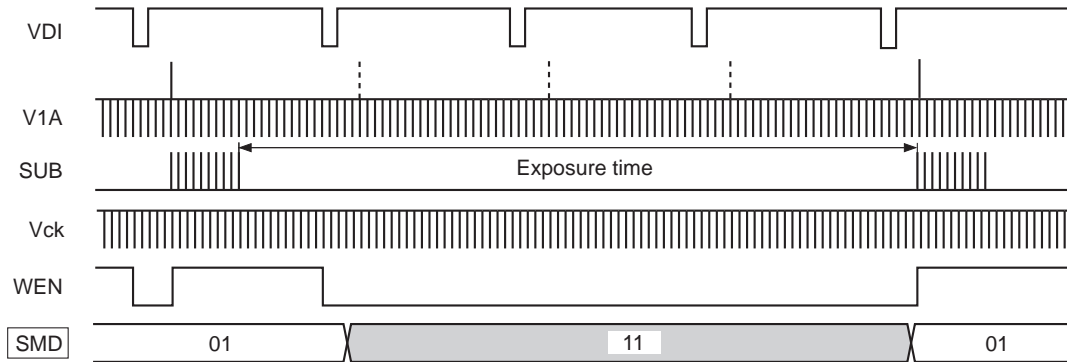
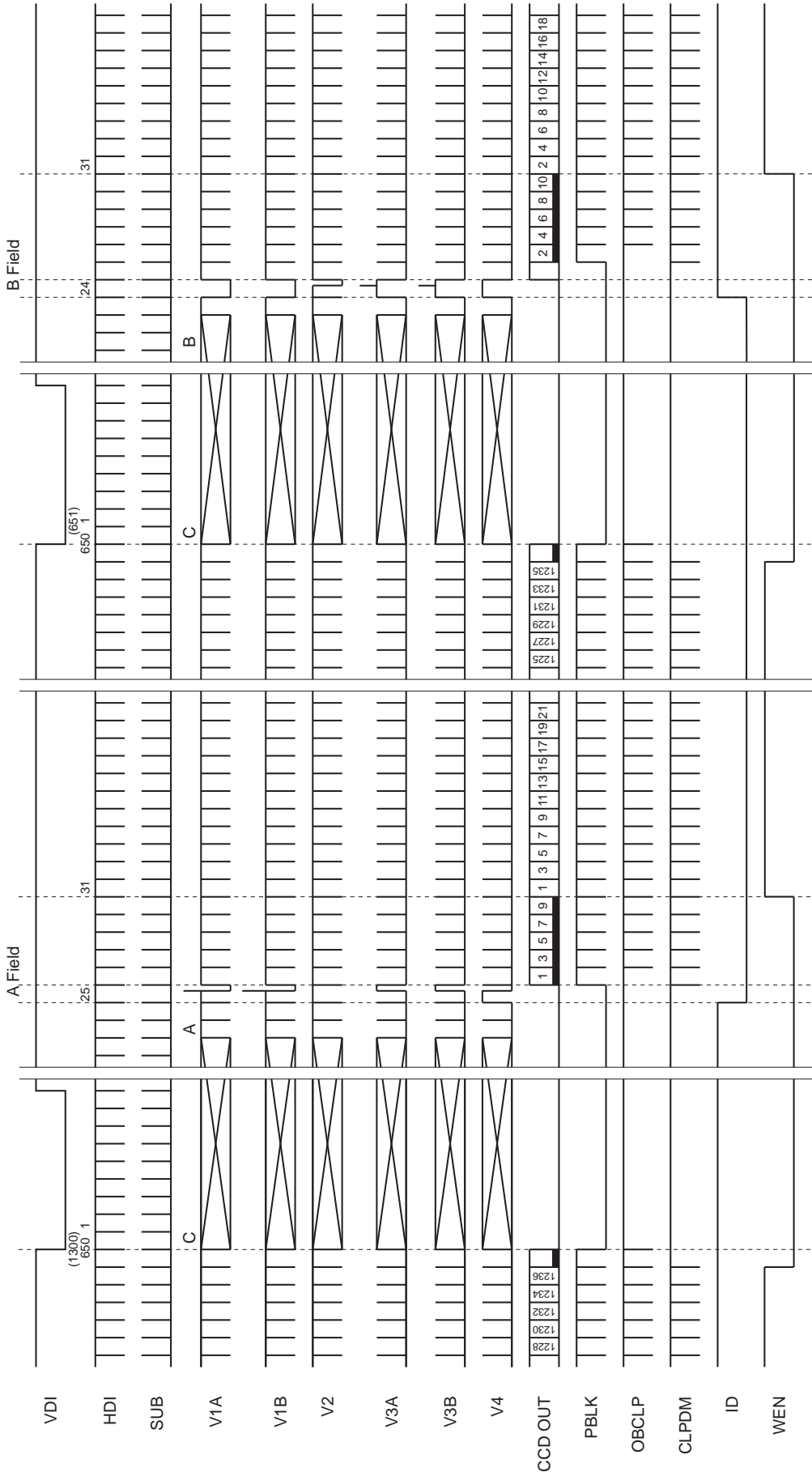

Chart-1 Vertical Direction Timing Chart
Applicable CCD image sensor
 • ICX224/ICX284

MODE
 Frame mode



* The number of SUB pulses is determined by the serial interface. This chart shows the case where SUB pulses are output in each horizontal period.
 * ID is low for lines where CCD OUT contains the R component, and high for lines where CCD OUT contains the B component.

Chart-2 Vertical Direction Timing Chart
MODE
 Applicable CCD image sensor
 • ICX224/ICX284

Quadruple-speed mode

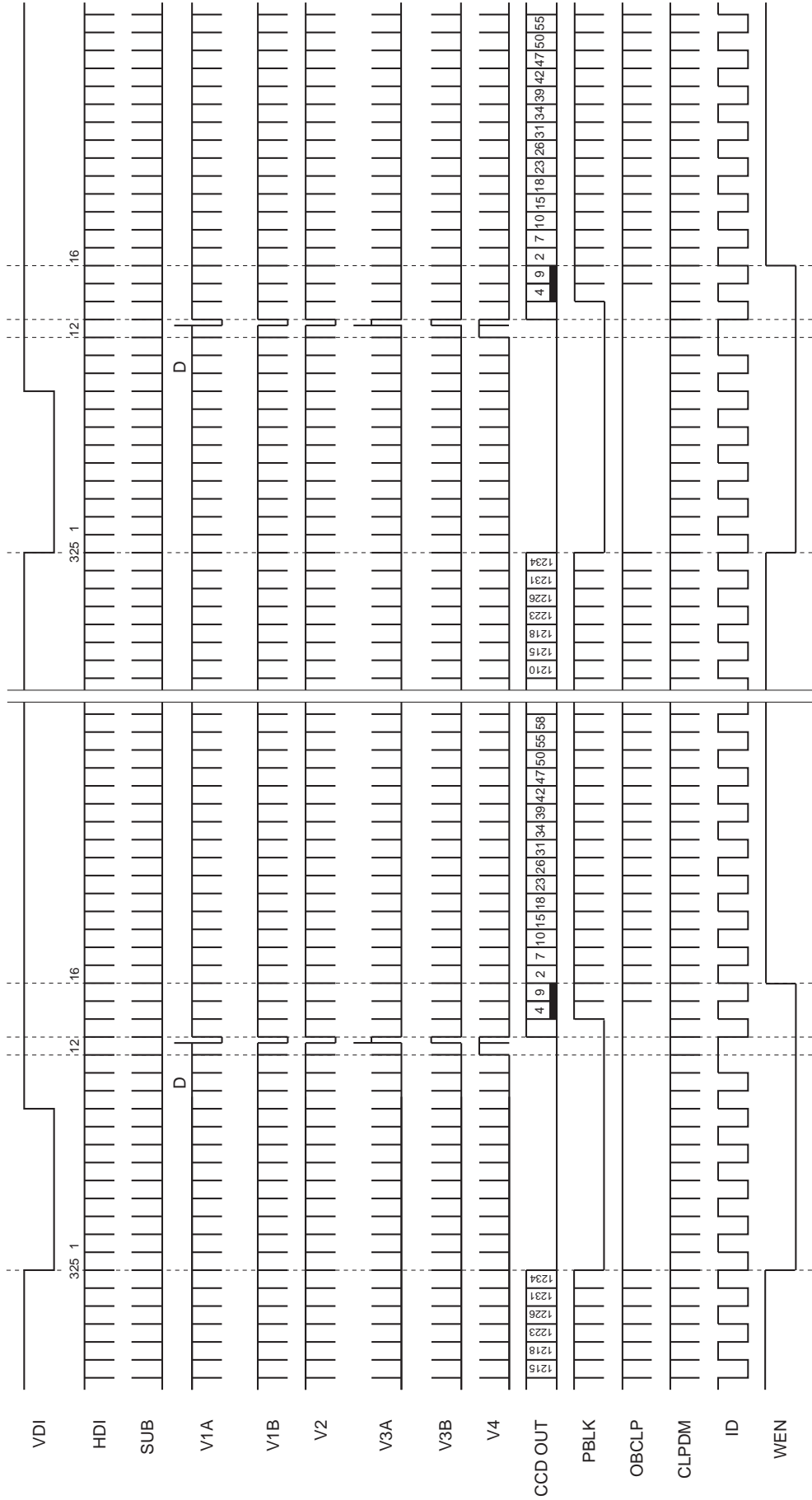

* The number of SUB pulses is determined by the serial interface. This chart shows the case where SUB pulses are output in each horizontal period.
 * ID is low for lines where CCD OUT contains the R component, and high for lines where CCD OUT contains the B component.

Applicable CCD image sensor
• ICX224/ICX284

MODE
Frame mode

Chart-3 Horizontal Direction Timing Chart

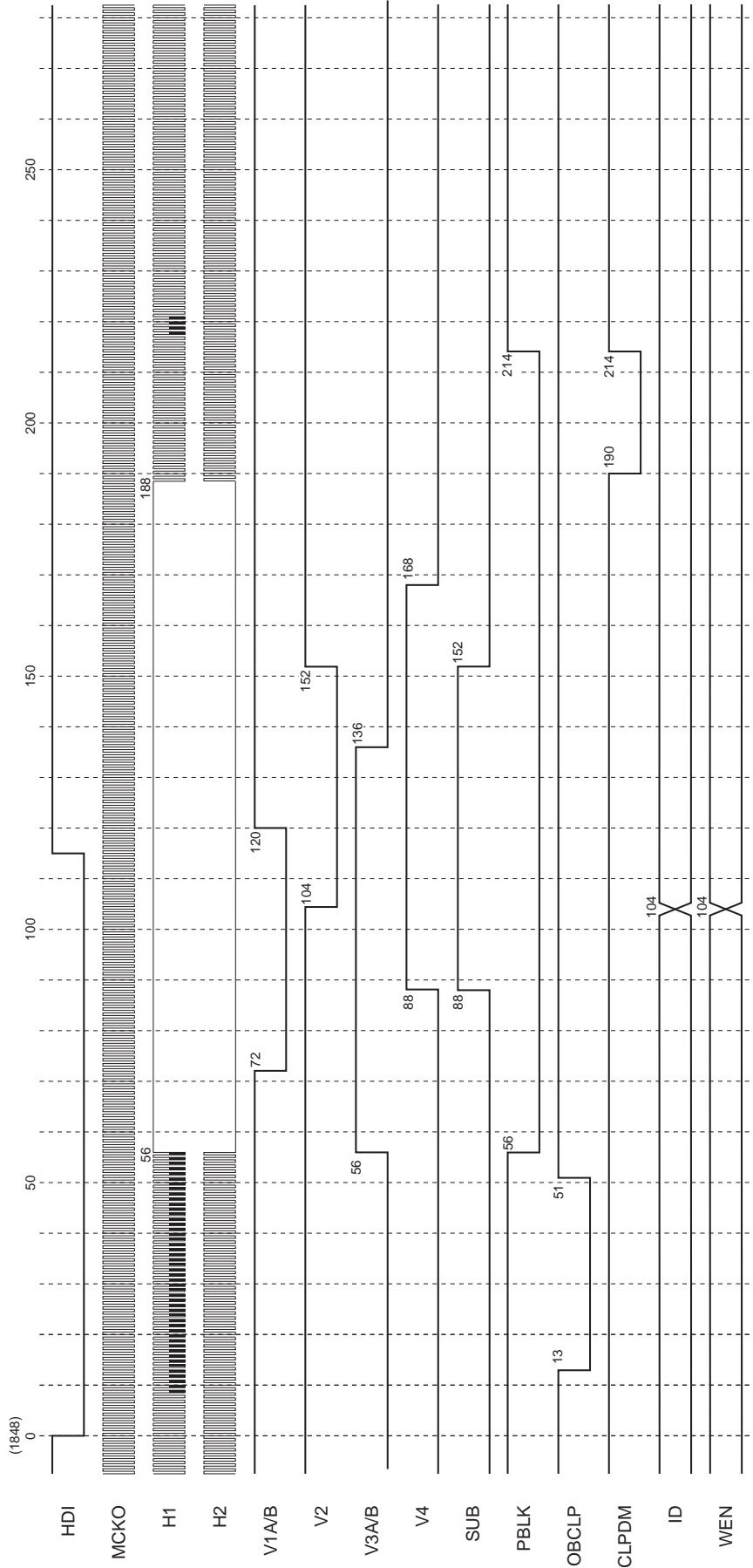

* The HDI of this chart indicates the actual CXD2470R load timing.
 * The numbers at the output pulse transition points indicate the count at the MCKO rise from the fall of HDI.
 * The HDI fall period should be between approximately 3.1 to 10.4μs (when the drive frequency is 18MHz). This chart shows a period of 115ck (6.4μs).
 * SUB is output at the timing shown above when output is controlled by the serial interface data.
 * ID and WEN are output at the timing shown above at the position shown in Chart-1.

Applicable CCD image sensor
 • ICX224/ICX284

MODE
 Quadruple-speed mode

Chart-4 Horizontal Direction Timing Chart

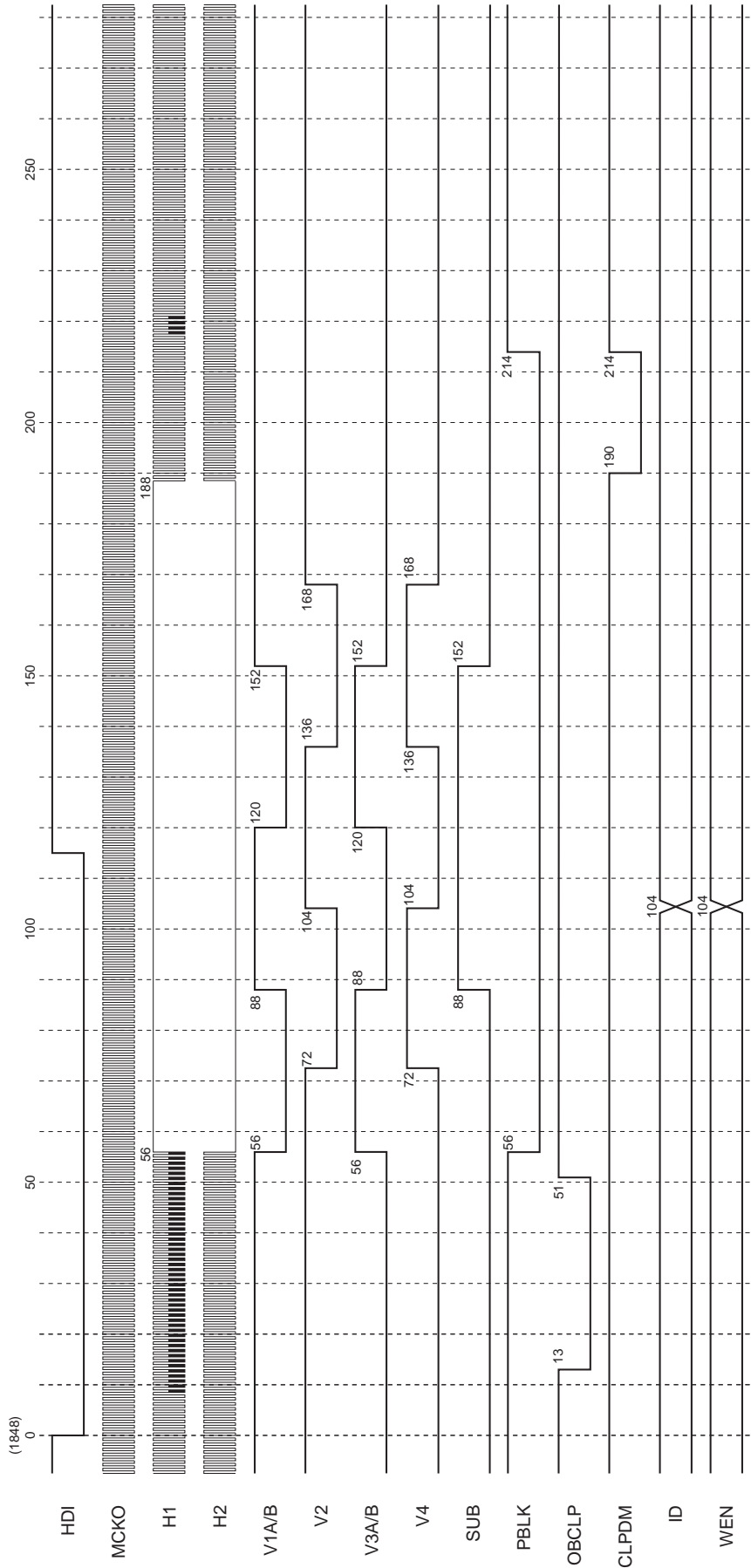

* The HDI of this chart indicates the actual CXD2470R load timing.
 * The numbers at the output pulse transition points indicate the count at the MCKO rise from the fall of HDI.
 * The HDI fall period should be between approximately 3.1 to 10.4μs (when the drive frequency is 18MHz). This chart shows a period of 115ck (6.4μs).
 * SUB is output at the timing shown above when output is controlled by the serial interface data.
 * ID and WEN are output at the timing shown above at the position shown in Chart-2.

Chart-5 Horizontal Direction Timing Chart
(High-speed sweep: C)

MODE
Frame mode

Applicable CCD image sensor
• ICX224/ICX284

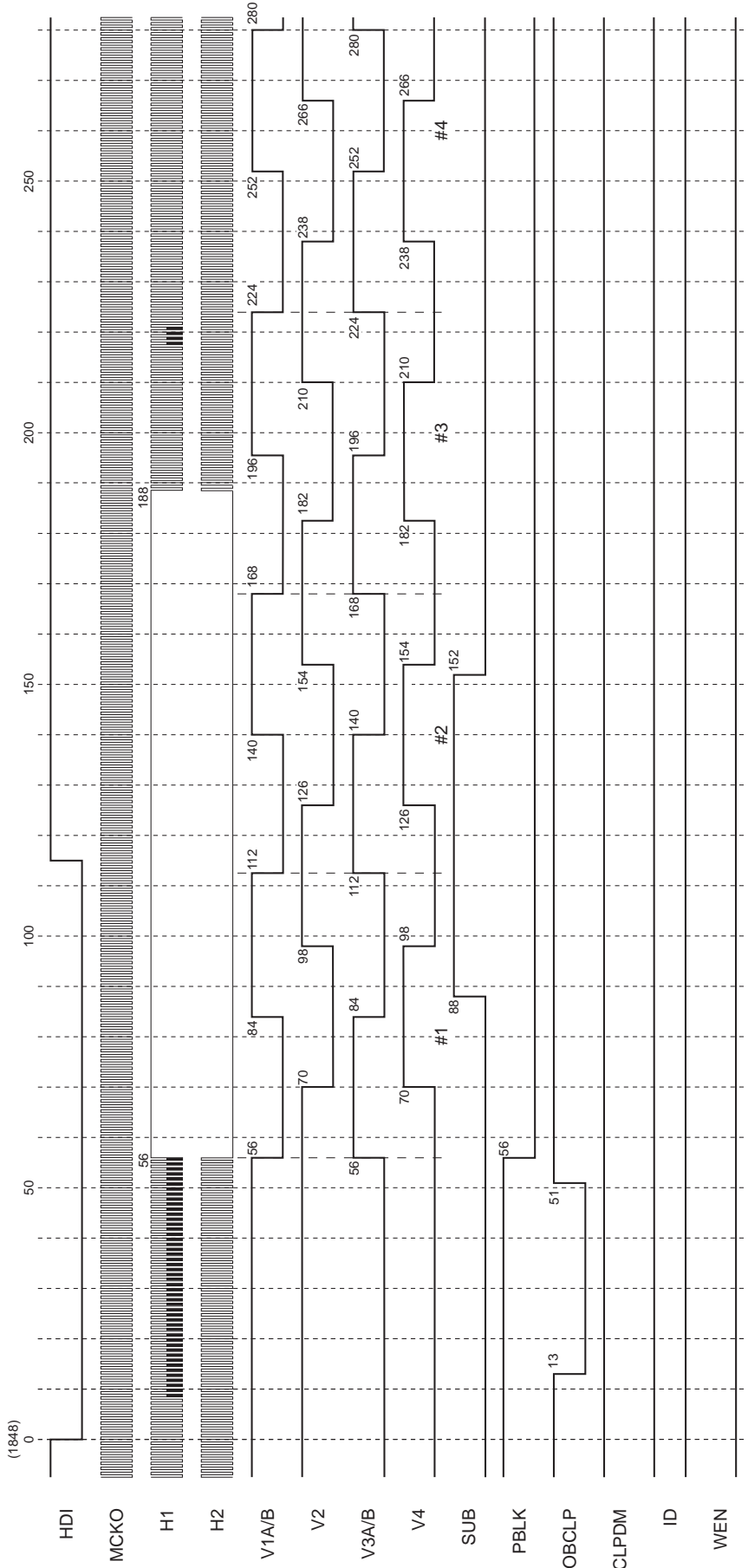

* The HDI of this chart indicates the actual CXD2470R load timing.
 * The numbers at the output pulse transition points indicate the count at the MCKO rise from the fall of HDI.
 * The HDI fall period should be between approximately 3.1 to 10.4µs (when the drive frequency is 18MHz). This chart shows a period of 115ck (6.4µs).
 * SUB is output at the timing shown above when output is controlled by the serial interface data.
 * High-speed sweep of V1A/B, V2, V3A/B and V4 is performed up to 22H of 1848ck (#758).

Applicable CCD image sensor
 • ICX224/ICX284

MODE
 Frame mode

Chart-6 Horizontal Direction Timing Chart

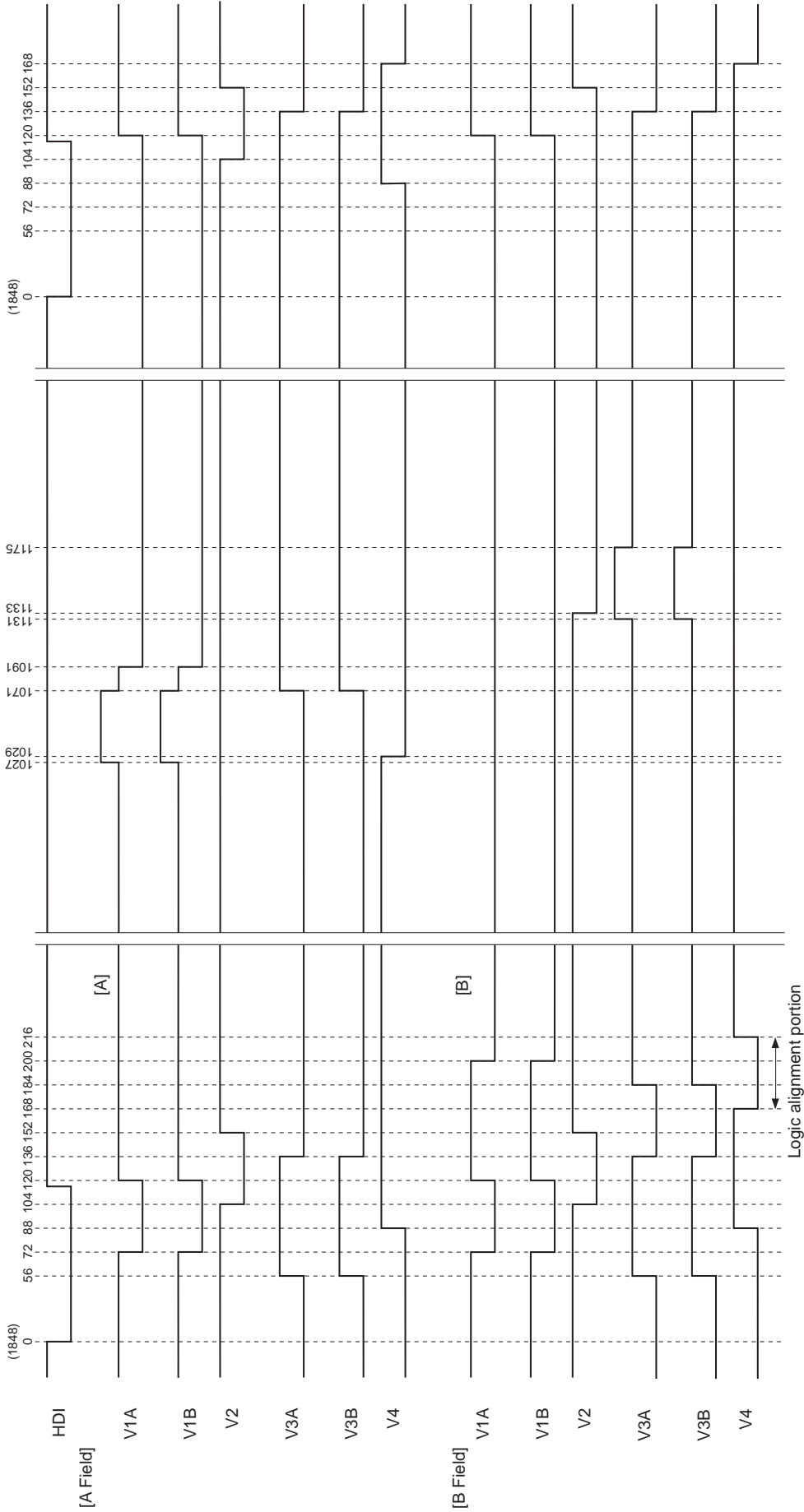

* The HDI of this chart indicates the actual CXD2470R load timing.
 * The numbers at the output pulse transition points indicate the count at the MCKO rise from the fall of HDI.
 * The HDI fall period should be between approximately 3.0 to 13.4µs (when the drive frequency is 18MHz). This chart shows a period of 115ck (6.4µs).

Chart-7 Horizontal Direction Timing Chart

MODE

Quadruple-speed mode

Applicable CCD image sensor

- ICX224/ICX284

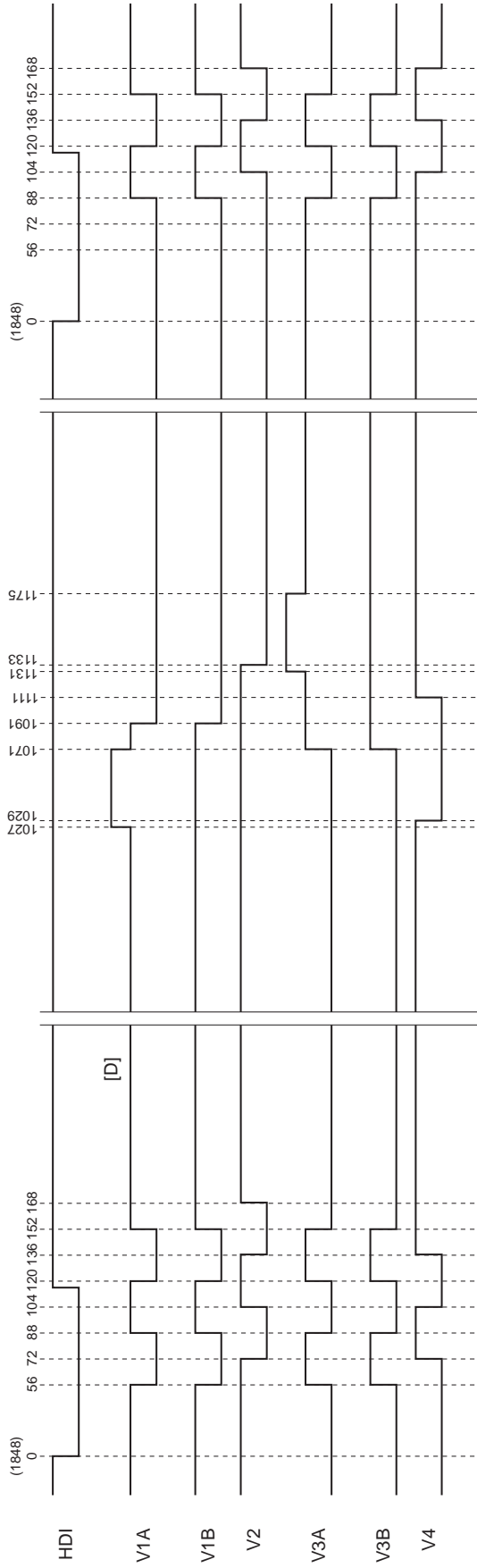

* The HDI of this chart indicates the actual CXD2470R load timing.
 * The numbers at the output pulse transition points indicate the count at the MCKO rise from the fall of HDI.
 * The HDI fall period should be between approximately 3.1 to 10.4 μ s (when the drive frequency is 18MHz). This chart shows a period of 115ck (6.4 μ s).

Applicable CCD image sensor
• ICX202/ICX232

MODE
Frame mode

Chart-8 Vertical Direction Timing Chart

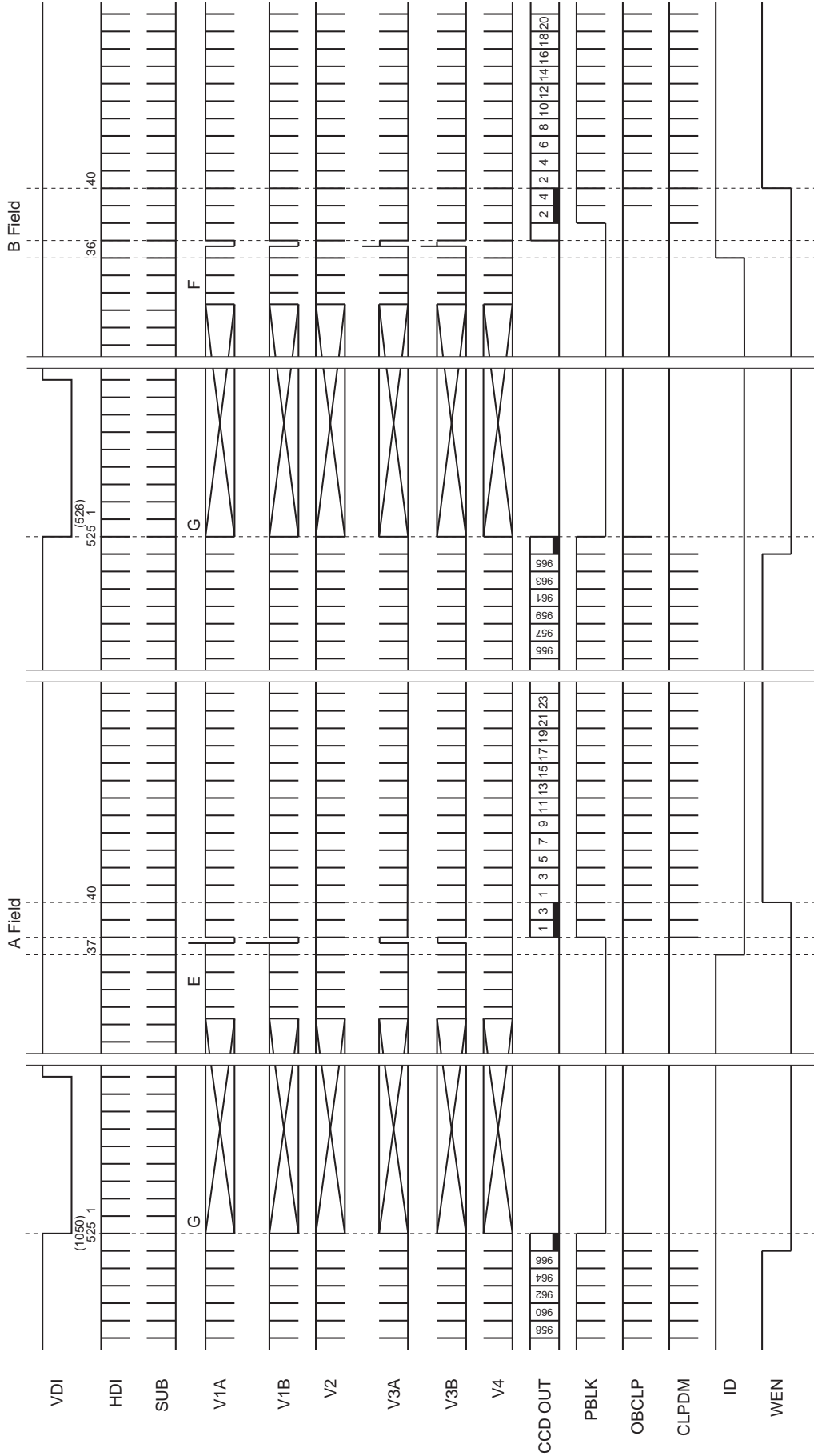

* The number of SUB pulses is determined by the serial interface data. This chart shows the case where SUB pulses are output in each horizontal period.
* ID is low for lines where CCD OUT contains the R component, and high for lines where CCD OUT contains the B component.

Chart-9 Vertical Direction Timing Chart

Applicable CCD image sensor
• ICX202/ICX232

MODE

Quadruple-speed mode

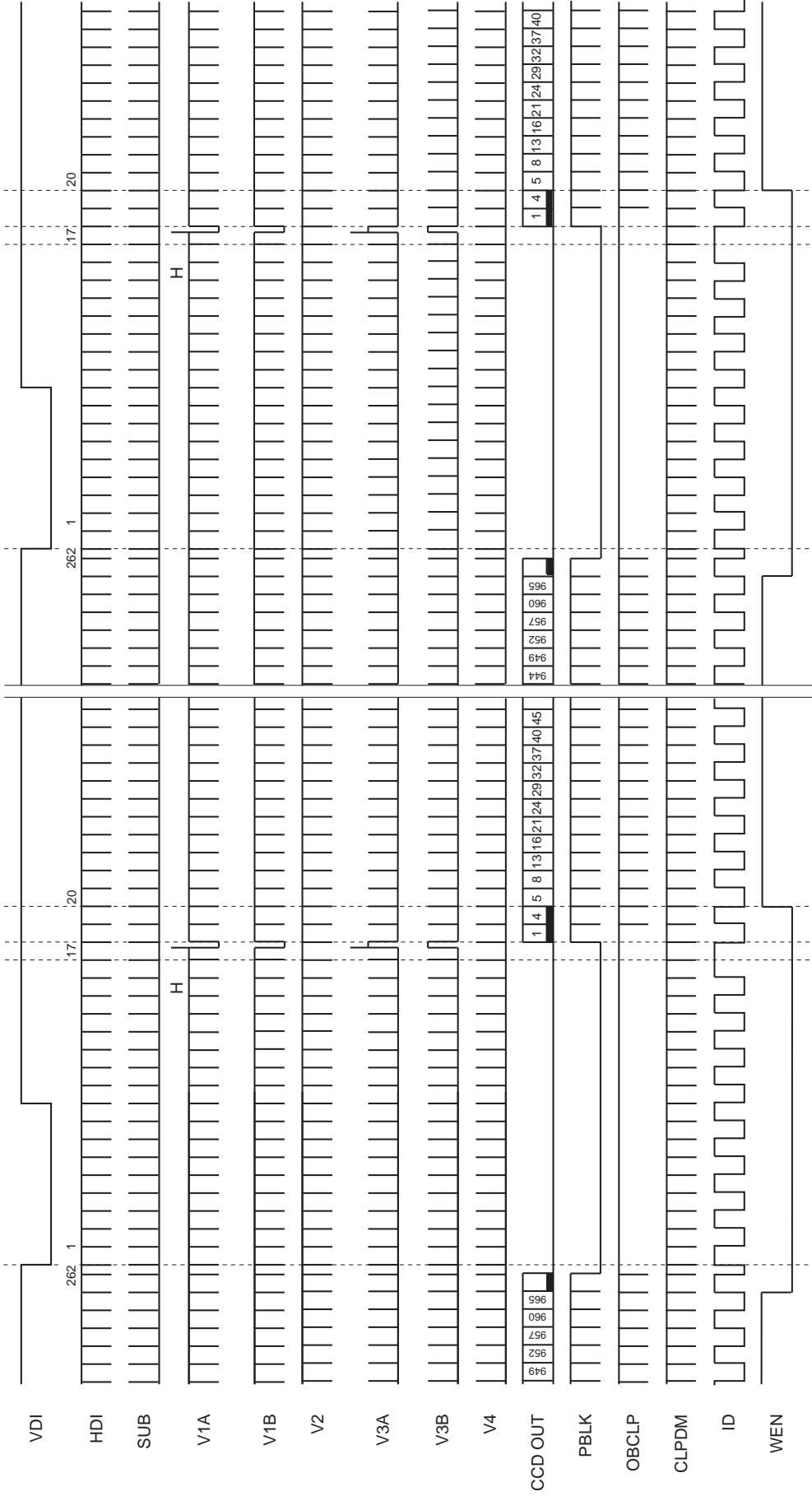

* The number of SUB pulses is determined by the serial interface data. This chart shows the case where SUB pulses are output in each horizontal period.

* ID is low for lines where CCD OUT contains the R component, and high for lines where CCD OUT contains the B component.

Applicable CCD image sensor
• ICX202/ICX232

MODE
Frame mode

Chart-10 Horizontal Direction Timing Chart

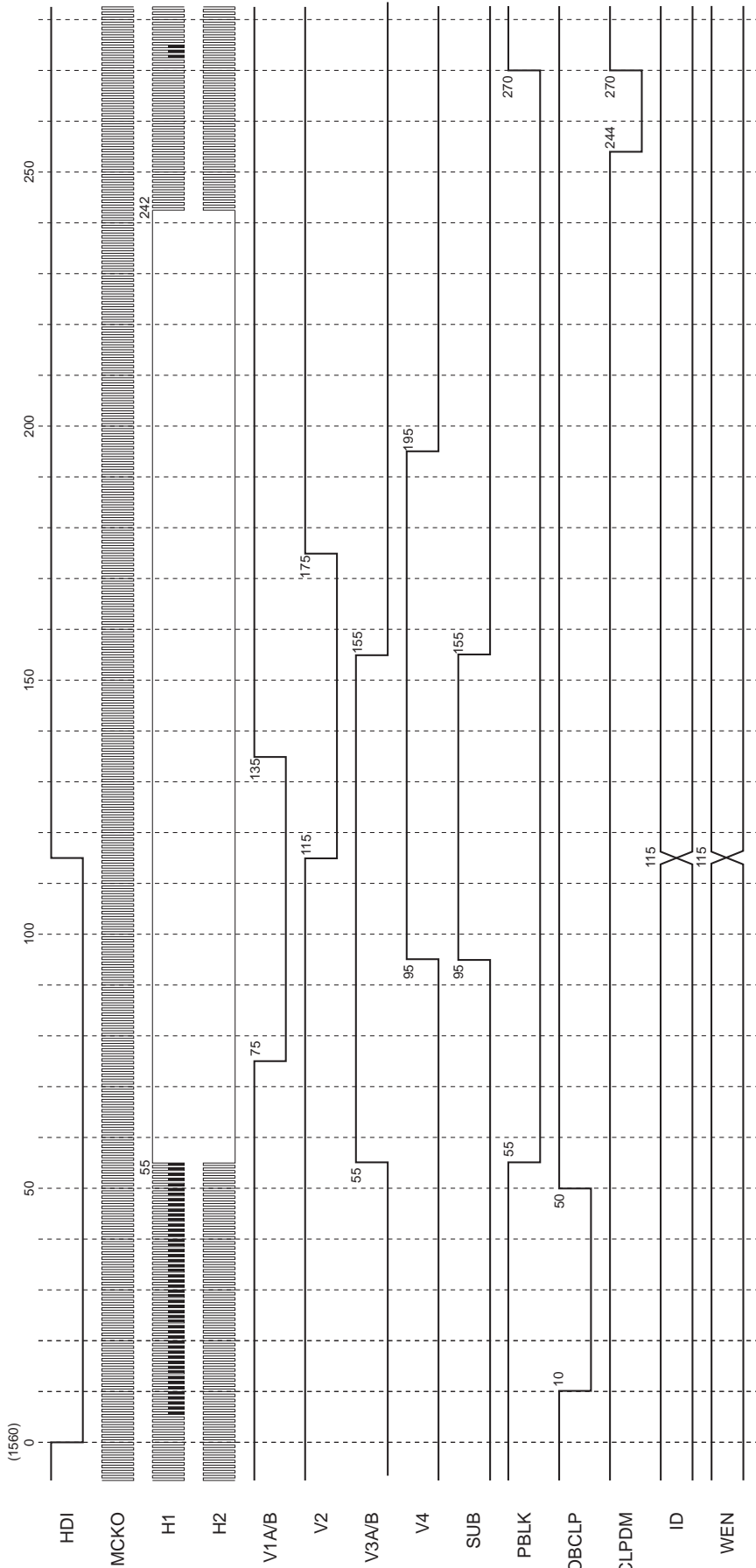

* The HDI of this chart indicates the actual CXD2470R load timing.
 * The numbers at the output pulse transition points indicate the count at the MCKO rise from the fall of HDI.
 * The HDI fall period should be between approximately 3.0 to 13.4μs (when the drive frequency is 18MHz). This chart shows a period of 115ck (6.4μs).
 * SUB is output at the timing shown above when output is controlled by the serial interface data.
 * ID and WEN are output at the timing shown above at the position shown in Chart-8.

Applicable CCD image sensor
 • ICX202/ICX232

MODE
 Quadruple-speed mode

Chart-11 Horizontal Direction Timing Chart

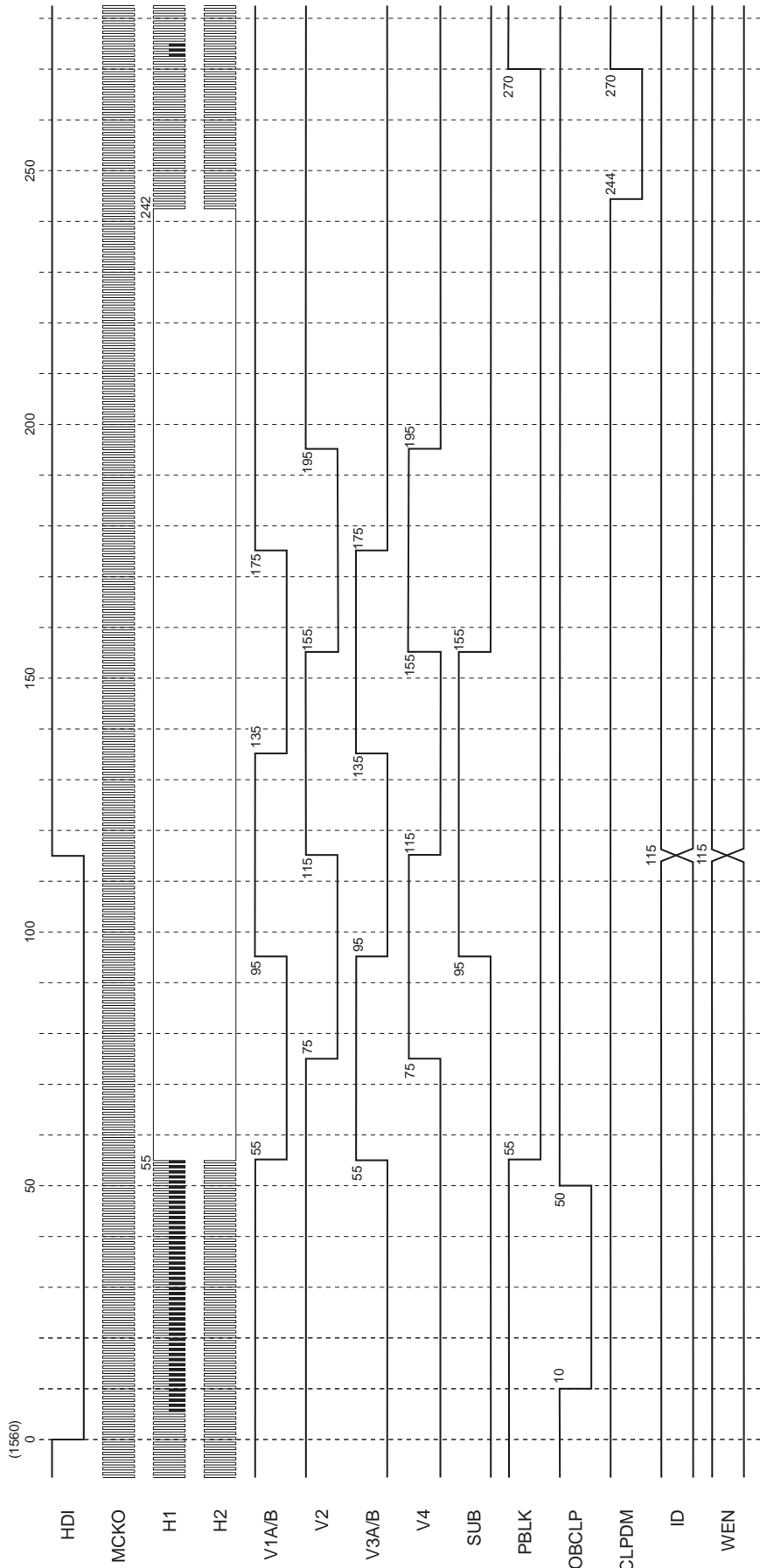

* The HDI of this chart indicates the actual CXD2470R load timing.
 * The numbers at the output pulse transition points indicate the count at the MCKO rise from the fall of HDI.
 * The HDI fall period should be between approximately 3.0 to 13.4μs (when the drive frequency is 18MHz). This chart shows a period of 115ck (6.4μs).
 * SUB is output at the timing shown above when output is controlled by the serial interface data.
 * ID and WEN are output at the timing shown above at the position shown in Chart-9.

Applicable CCD image sensor
• ICX202/ICX232

MODE
Frame mode

Chart-12 Horizontal Direction Timing Chart
(High-speed sweep: G)

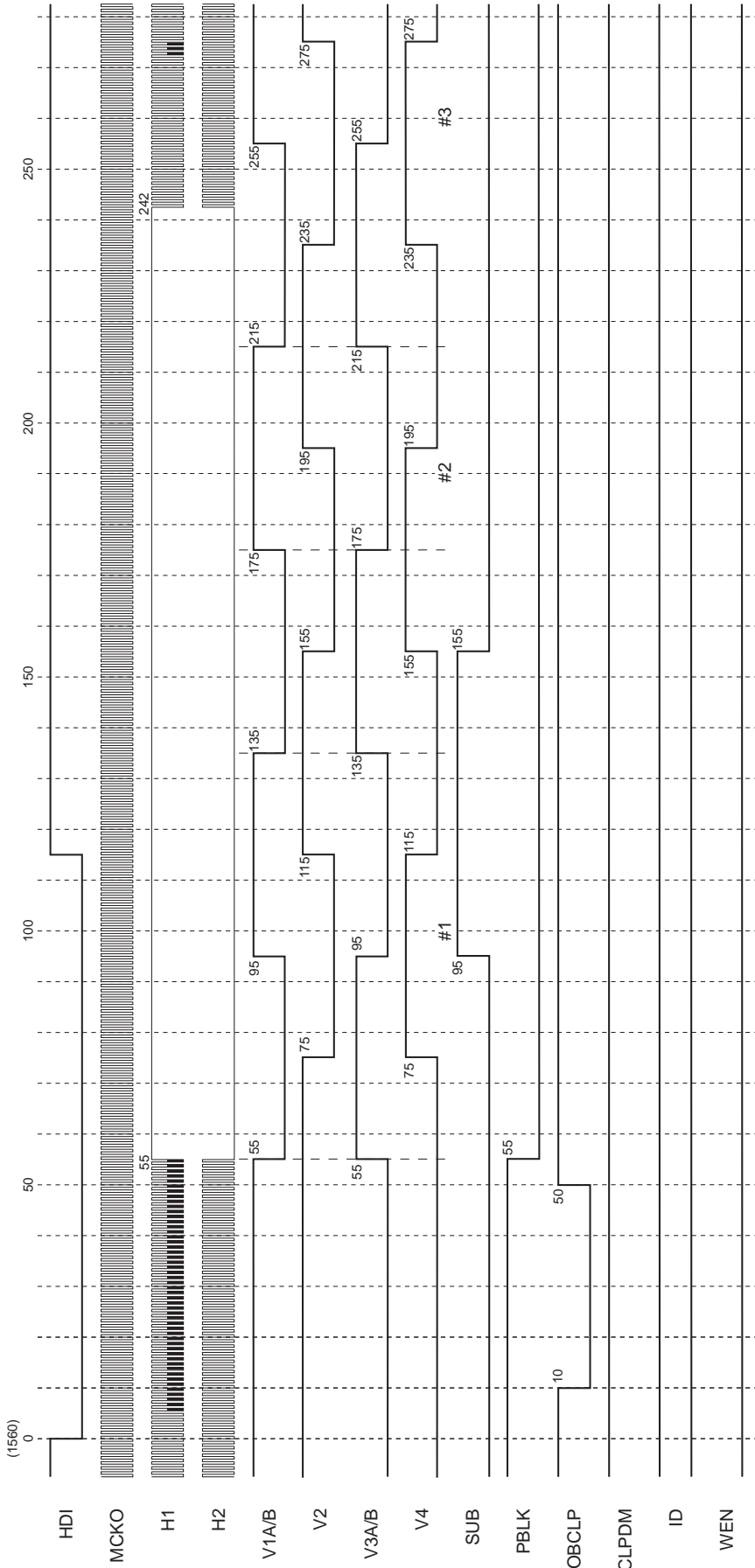

* The HDI of this chart indicates the actual CXD2470R load timing.
 * The numbers at the output pulse transition points indicate the count at the MCKO rise from the fall of HDI.
 * The HDI fall period should be between approximately 3.0 to 13.4µs (when the drive frequency is 18MHz). This chart shows a period of 115ck (6.4µs).
 * SUB is output at the timing shown above when output is controlled by the serial interface data.
 * High-speed sweep of V1A/B, V2, V3A/B and V4 is performed up to 33H of 1295ck (#659).

Applicable CCD image sensor
• ICX202/ICX232

MODE
Frame mode

Chart-13 Horizontal Direction Timing Chart

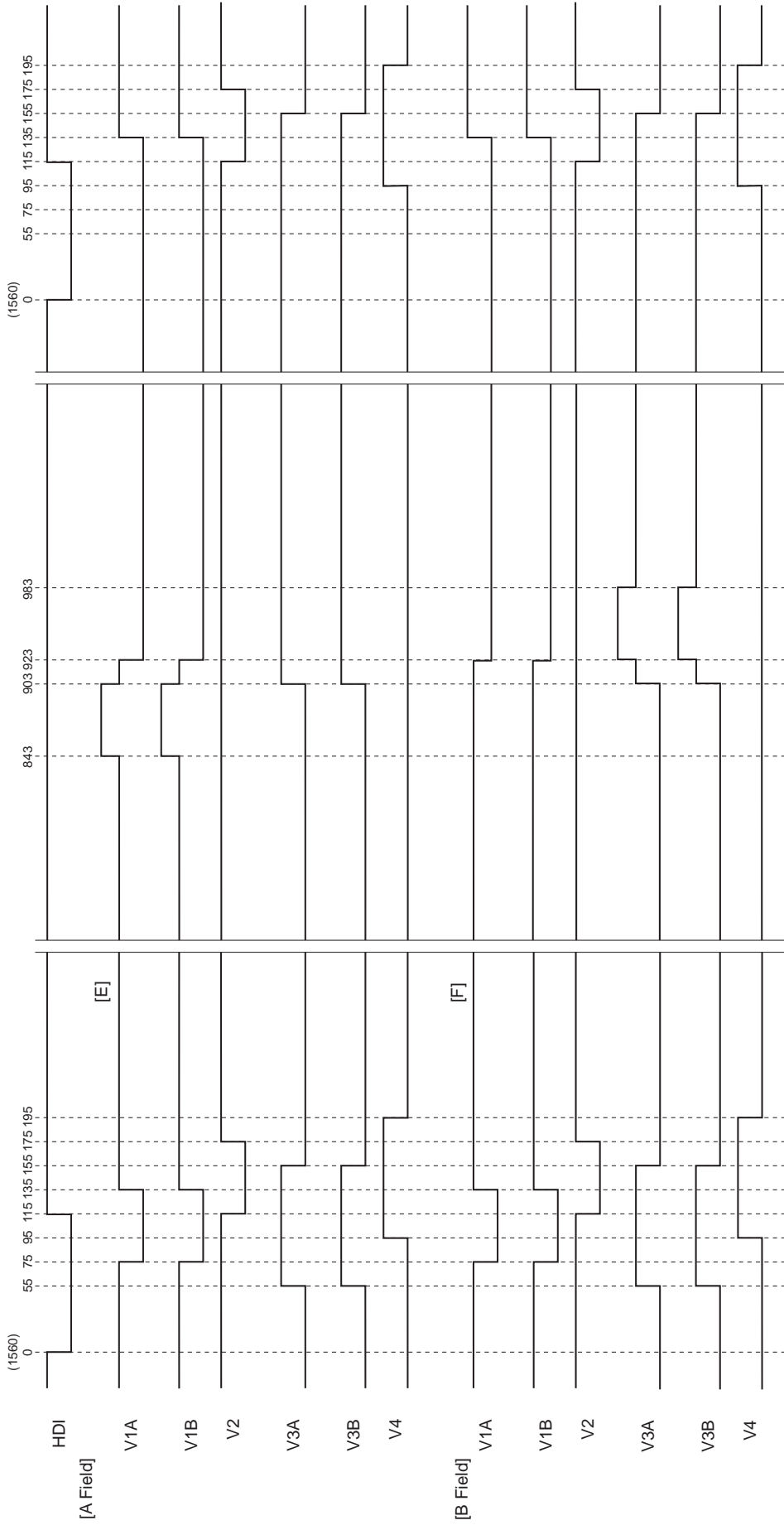

* The HDI of this chart indicates the actual CXD2470R load timing.
 * The numbers at the output pulse transition points indicate the count at the MCKO rise from the fall of HDI.
 * The HDI fall period should be between approximately 3.0 to 13.4μs (when the drive frequency is 18MHz). This chart shows a period of 115ck (6.4μs).

Chart-14 Horizontal Direction Timing Chart **MODE** **Applicable CCD image sensor**
 Quadruple-speed mode • ICX202/ICX232

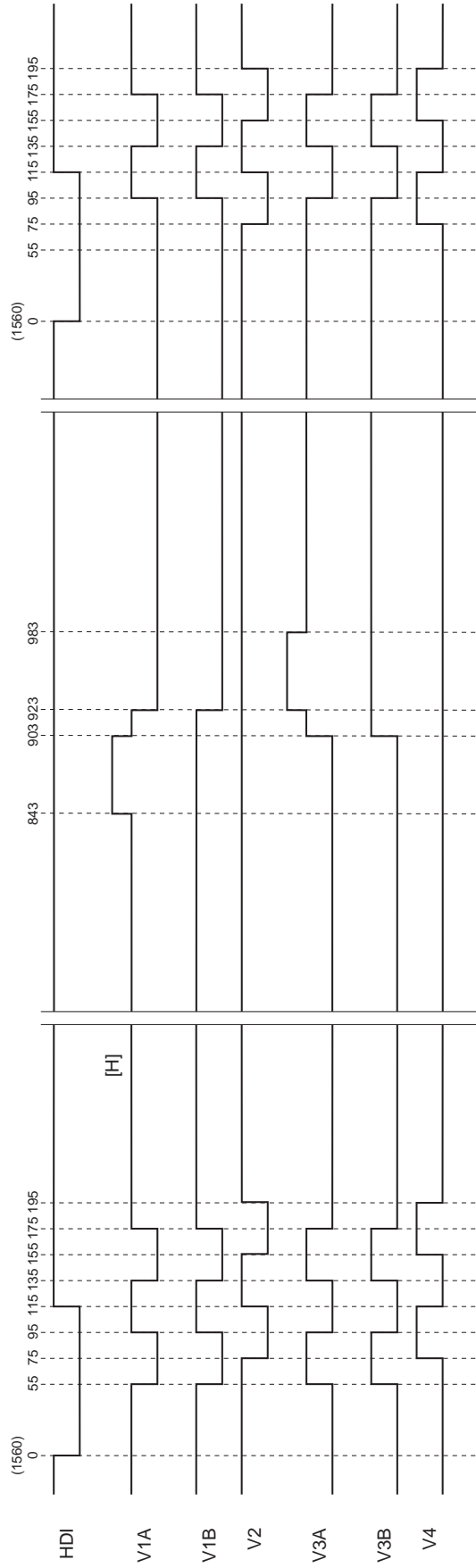

* The HDI of this chart indicates the actual CXD2470R load timing.
 * The numbers at the output pulse transition points indicate the count at the MCKO rise from the fall of HDI.
 * The HDI fall period should be between approximately 3.0 to 13.4μs (when the drive frequency is 18MHz). This chart shows a period of 115ck (6.4μs).

Applicable CCD image sensor
 • ICX224/ICX284/ICX202/ICX232

MODE

Chart-15 High-Speed Phase Timing Chart

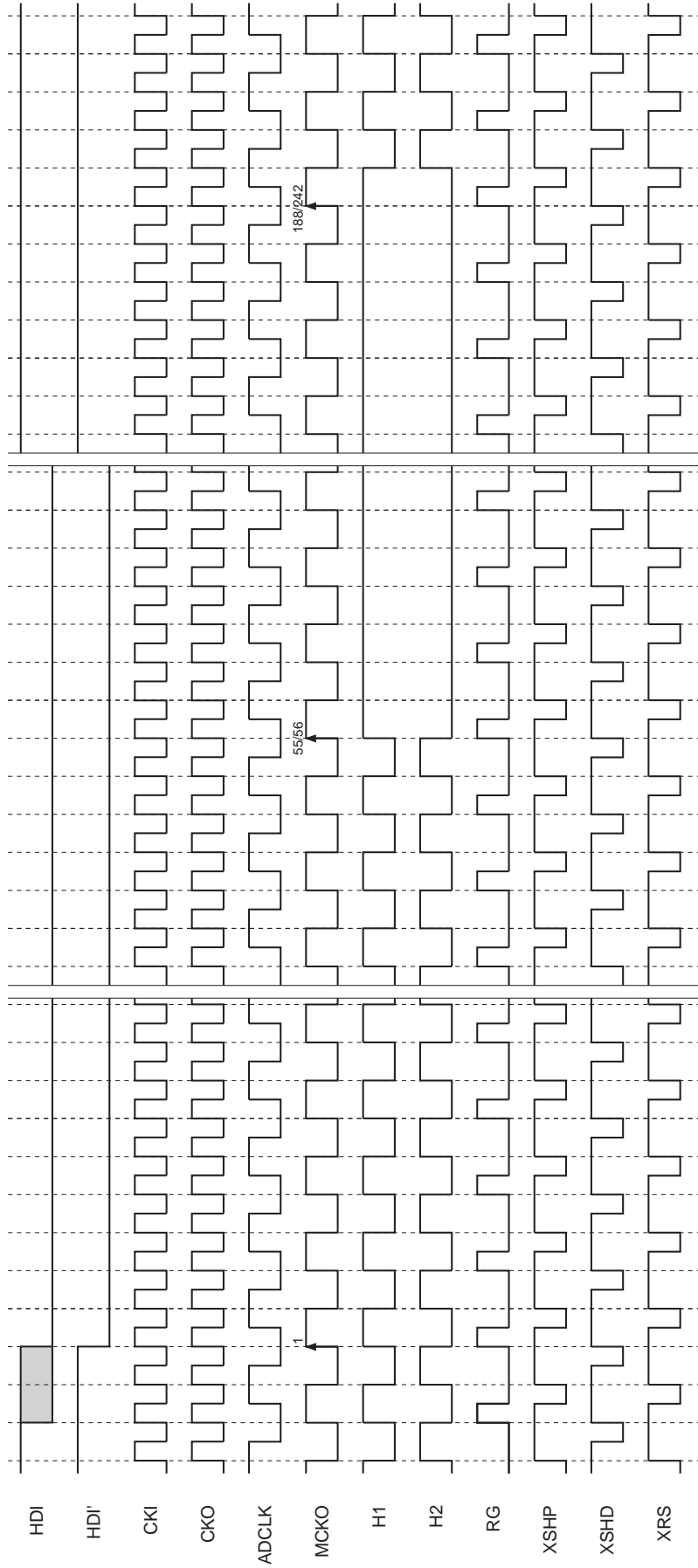

* HDI' indicates the HDI which is the actual CXD2470R load timing.

* The phase relationship of each pulse shows the logical position relationship. For the actual output waveform, a delay is added to each pulse.

* The logical phase of ADCLK can be specified by the serial interface.

Application Circuit Block Diagram

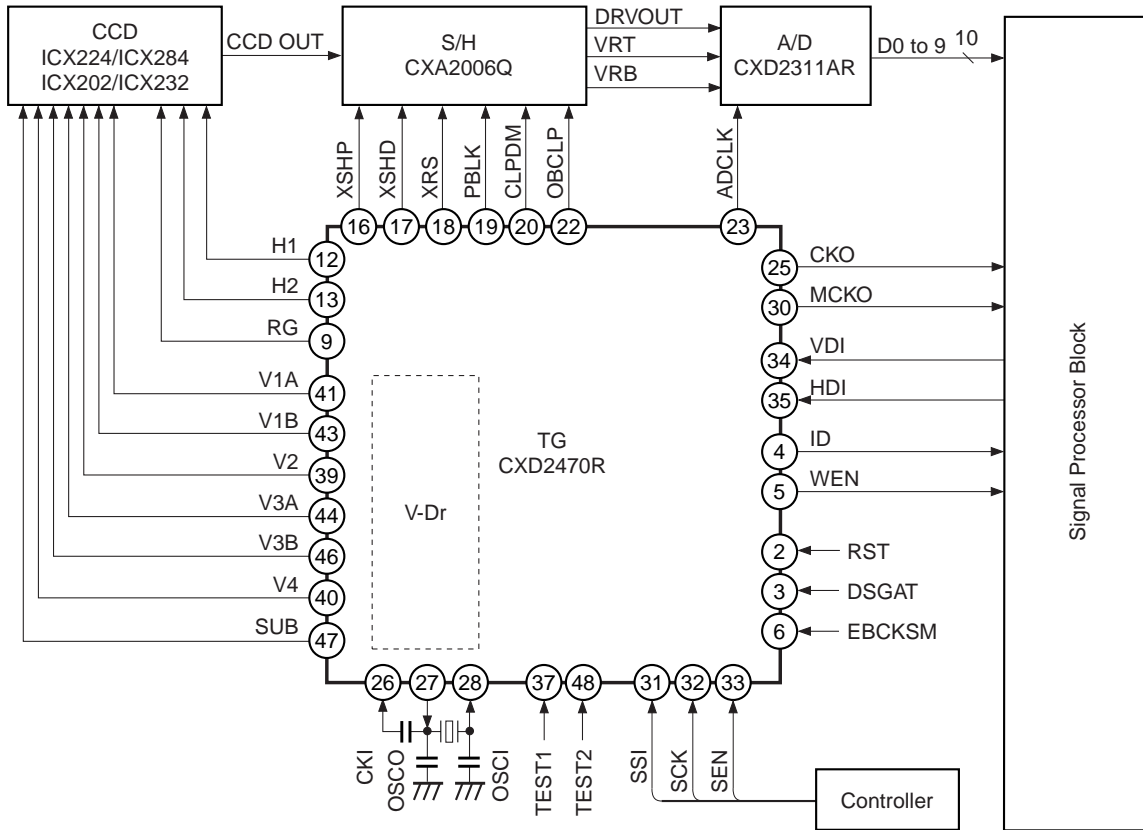

Application circuits shown are typical examples illustrating the operation of the devices. Sony cannot assume responsibility for any problems arising out of the use of these circuits or for any infringement of third party patent and other right due to same.

Notes for Power-on

Of the three -7.5V, +15.0V and +3.3V power supplies, be sure to start up the -7.5V and +15.0V power supplies in the following order to prevent the SUB pin of the CCD image sensor from going to negative potential.

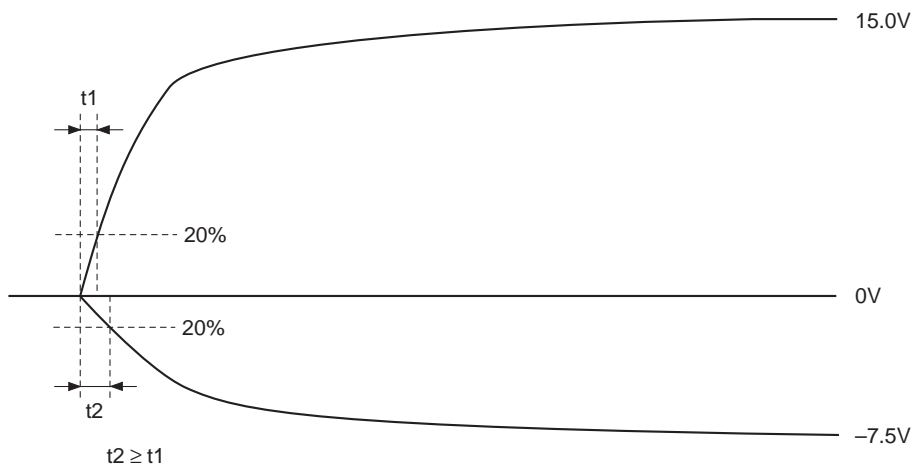

Package Outline Unit: mm

48PIN LQFP (PLASTIC)

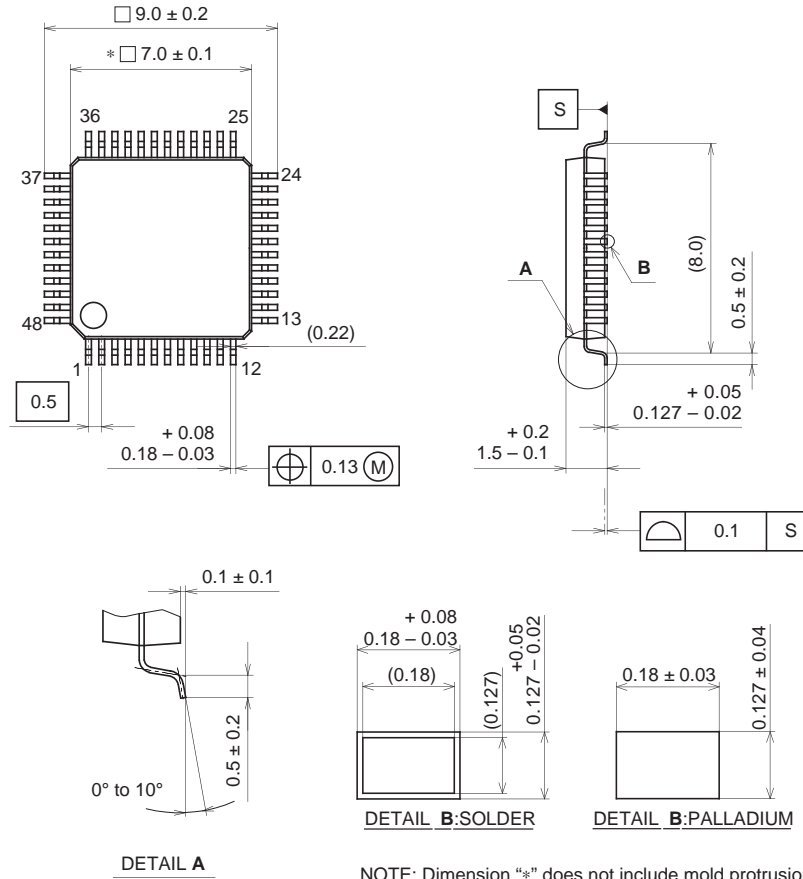

NOTE: Dimension "*" does not include mold protrusion.

PACKAGE STRUCTURE

SONY CODE	LQFP-48P-L01
EIAJ CODE	LQFP048-P-0707
JEDEC CODE	_____

PACKAGE MATERIAL	EPOXY RESIN
LEAD TREATMENT	SOLDER/PALLADIUM PLATING
LEAD MATERIAL	42/COPPER ALLOY
PACKAGE MASS	0.2g