



Buffered H-Bridge

FEATURES

- 1.0-A H-Bridge
- 200-kHz Switching Rate
- Shoot-Through Limited
- TTL Compatible Inputs
- 3.8- to 13.2-V Operating Range
- Surface Mount Packaging

APPLICATIONS

- VCM Driver
- Brushed Motor Driver
- Stepper Motor Driver
- Power Converter
- Optical Disk Drives
- Power Supplies
- High Performance Servo

DESCRIPTION

The Si9986 is an integrated, buffered H-bridge with TTL compatible inputs and the capability of delivering a continuous 1.0 A @ $V_{DD} = 12\text{ V}$ (room temperature) at switching rates up to 200 kHz. Internal logic prevents the upper and lower outputs of either half-bridge from being turned on simultaneously. Unique input codes allow both outputs to be forced low (for braking) or forced to a high impedance level.

The Si9986 is available in both standard and lead (Pb)-free, 8-pin SOIC packages, specified to operate over a voltage range of 3.8 V to 13.2 V, and the commercial temperature range of 0 to 70°C (C suffix) and the industrial temperature range of -40 to 85°C (D suffix).

FUNCTIONAL BLOCK DIAGRAM, PIN CONFIGURATION AND TRUTH TABLE

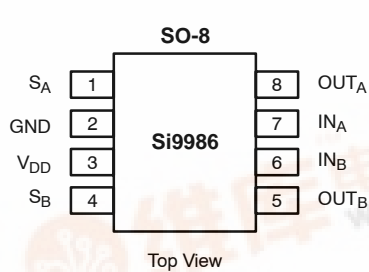

TRUTH TABLE			
IN _A	IN _B	OUT _A	OUT _B
1	0	1	0
0	1	0	1
0	0	0	0
1	1	HiZ	HiZ

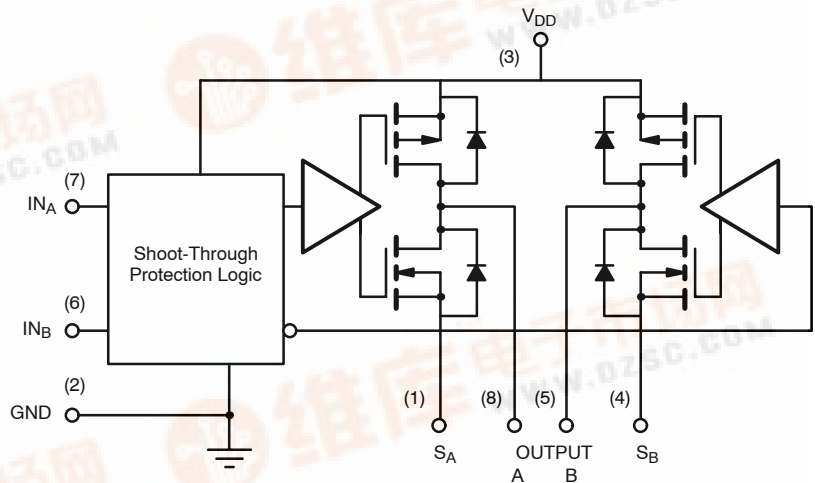

ORDERING INFORMATION

Part Number	Temperature Range	Package
Si9986CY-T1	0 to 70°C	Tape and Reel
Si9986DY-T1	-40 to 85°C	
Si9986CY-T1—E3	0 to 70°C	Lead Free Tape and Reel
Si9986DY-T1—E3	-40 to 85°C	
Si9986CY	0 to 70°C	Bulk (tubes)
Si9986DY	-40 to 85°C	



Si9986

Vishay Siliconix



ABSOLUTE MAXIMUM RATINGS^a

Voltage on any pin with respect to ground -0.3 V to $V_{DD} + 0.3$ V
Voltage on pins 5, 8 with respect to GND -1 V to $V_{DD} + 1$ V
Voltage on pins 1, 4 -0.3 V to GND +1 V
Peak Output Current 1.5 A
Storage Temperature -65 to 150°C
Maximum Junction Temperature (T_J) 150°C
Maximum V_{DD} 15 V

Power Dissipation ^b 1 W
θ_{JA} 100°C/W
Operating Temperature Range	
Si9986CY 0 to 70°C
Si9986DY -40 to 85°C

- Notes
- Device mounted with all leads soldered or welded to PC board.
 - Derate 10 mW/°C above 25°C.

RECOMMENDED OPERATING RANGE

V_{DD} 3.8 V to 13.2 V
Maximum Junction Temperature (T_J) 125°C

SPECIFICATIONS							
Parameter	Symbol	Test Conditions Unless Otherwise Specified $V_{DD} = 3.8$ to 13.2 V $S_A @ GND, S_B @ GND$		Limits			Unit
				Min ^a	Typ ^b	Max ^a	
Input							
Input Voltage High	V_{INH}			2			V
Input Voltage Low	V_{INL}					1	
Input Current with Input Voltage High	I_{INH}		$V_{IN} = 2$ V			1	μ A
Input Current with Input Voltage Low	I_{INL}		$V_{IN} = 0$ V	-1			
Output							
Output Voltage High	V_{OUTH}	$I_{OUT} = -500$ mA	$V_{DD} = 10.8$ V	10.5	10.7		V
			$V_{DD} = 4.5$ V	4.1	4.3		
		$I_{OUT} = -300$ mA, $V_{DD} = 3.8$ V		3.4	3.7		
Output Voltage Low	V_{OUTL}	$I_{OUT} = 500$ mA	$V_{DD} = 10.8$ V		0.2	0.3	
			$V_{DD} = 4.5$ V		0.2	0.4	
		$I_{OUT} = 300$ mA, $V_{DD} = 3.8$ V			0.1	0.4	
Output Leakage Current High	I_{OLH}	$I_{NA} = I_{NB} \geq 2$ V, $V_{OUT} = V_{DD} = 13.2$ V		-10	0		μ A
Output Leakage Current Low	I_{OLL}	$V_{OUT} = 0$, $V_{DD} = 13.2$ V			0	10	
Output V Clamp High	V_{CLH}	$I_{NA} = I_{NB} \geq 2$ V	$I_{OUT} = 100$ mA		$V_{DD} + 0.7$		V
Output V Clamp Low	V_{CLL}		$I_{OUT} = -100$ mA		-0.7		
Supply							
V_{DD} Supply Current	I_{DD}	$I_N = 100$ kHz, $V_{DD} = 5$ V			2		mA
		$I_{NA} = I_{NB} = 4.5$ V, $V_{DD} = 5.5$ V				300	μ A
Dynamic							
Propogation Delay Time	T_{PLH}	$V_{DD} = 5$ V			300		nS
	T_{PHL}				100		

- Notes
- The algebraic convention whereby the most negative value is a minimum and the most positive a maximum, is used in this data sheet.
 - Typical values are for DESIGN AID ONLY, not guaranteed nor subject to production testing.



TYPICAL CHARACTERISTICS (25°C UNLESS NOTED)

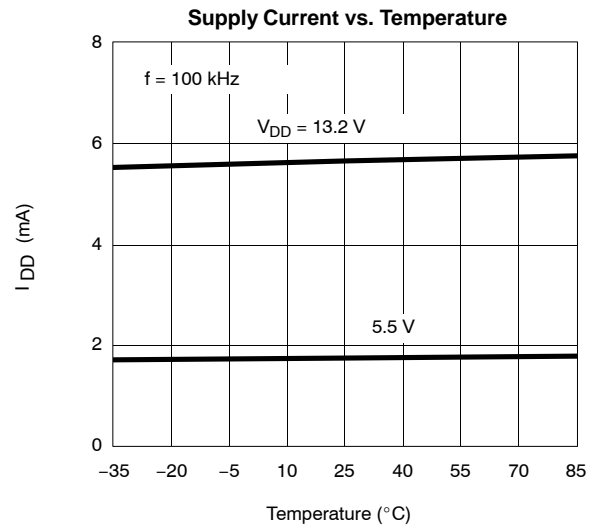
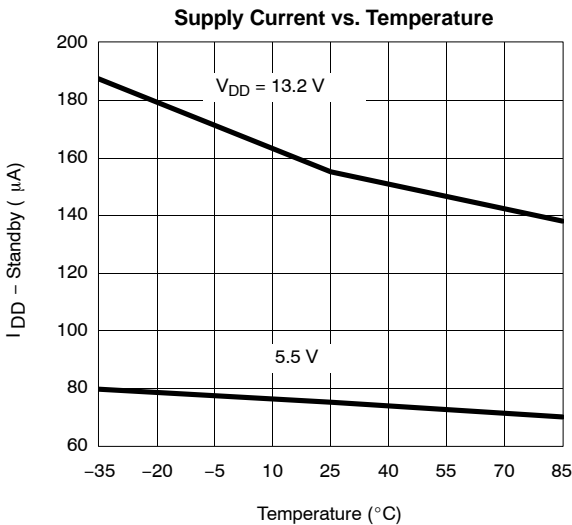
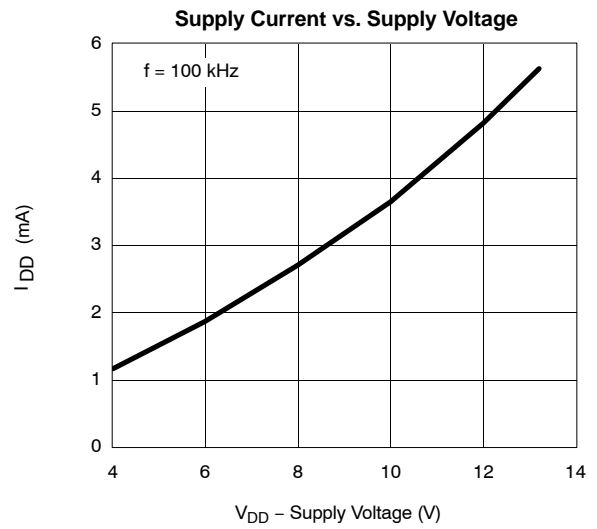
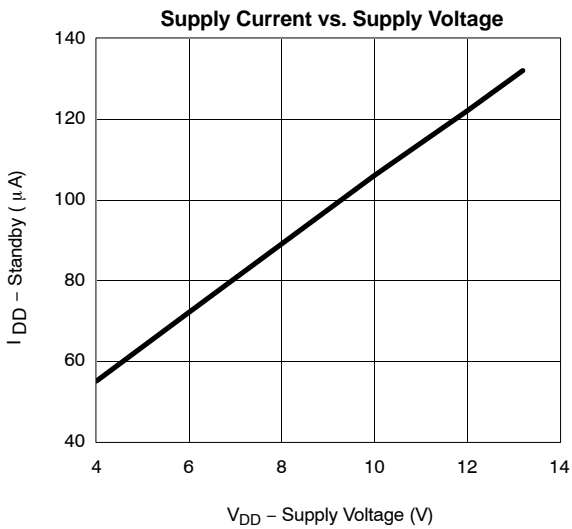
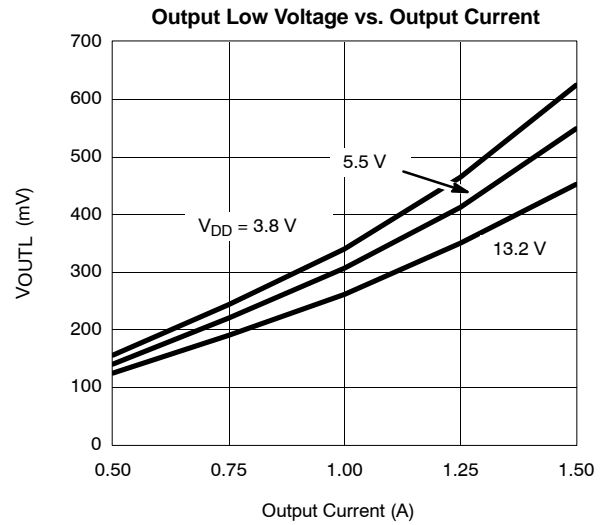
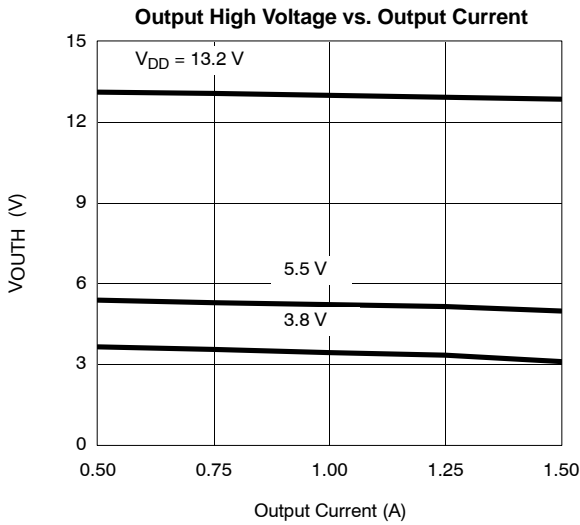



TYPICAL CHARACTERISTICS (25 °C UNLESS NOTED)

