

SHINDENGEN

Super Fast Recovery Rectifiers

Dual

D20LC40

400V 20A

FEATURES

- Low noise
- trr50ns
- Fully Isolated Molding

APPLICATION

- Switching power supply
- Free Wheel
- Home Appliances, Office Equipment,
- Factory Automation

OUTLINE DIMENSIONS

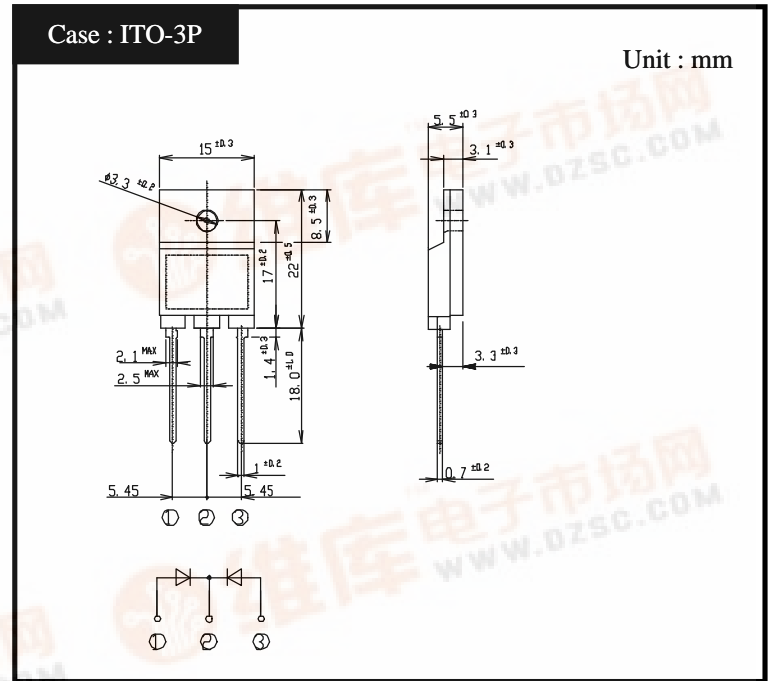

RATINGS

Absolute Maximum Ratings (If not specified Tc=25)

Item	Symbol	Conditions	Ratings	Unit
Storage Temperature	Tstg		-40 ~ 150	
Operating Junction Temperature	Tj		150	
Maximum Reverse Voltage	V _{RM}		400	V
Average Rectified Forward Current	I _O	50Hz sine wave, R-load, Rating for each diode I _O /2, Tc=102	20	A
Peak Surge Forward Current	I _{FSM}	50Hz sine wave, Non-repetitive 1 cycle peak value, Tj=25	120	A
Dielectric Strength	V _{dis}	Terminals to case, AC 1 minute	1.5	kV
Mounting Torque	TOR	(Recommended torque 0.5N·m)	0.8	N·m

Electrical Characteristics (If not specified Tc=25)

Item	Symbol	Conditions	Ratings	Unit
Forward Voltage	V _F	I _F =10A, Pulse measurement, Rating of per diode	Max.1.3	V
Reverse Current	I _R	V _R =V _{RM} , Pulse measurement, Rating of per diode	Max.10	μA
Reverse Recovery Time	trr	I _F =0.5A, I _R =1A, Rating of per diode	Max.50	ns
Thermal Resistance	jc	junction to case	Max.1.7	/W



D20LC40

Forward Voltage

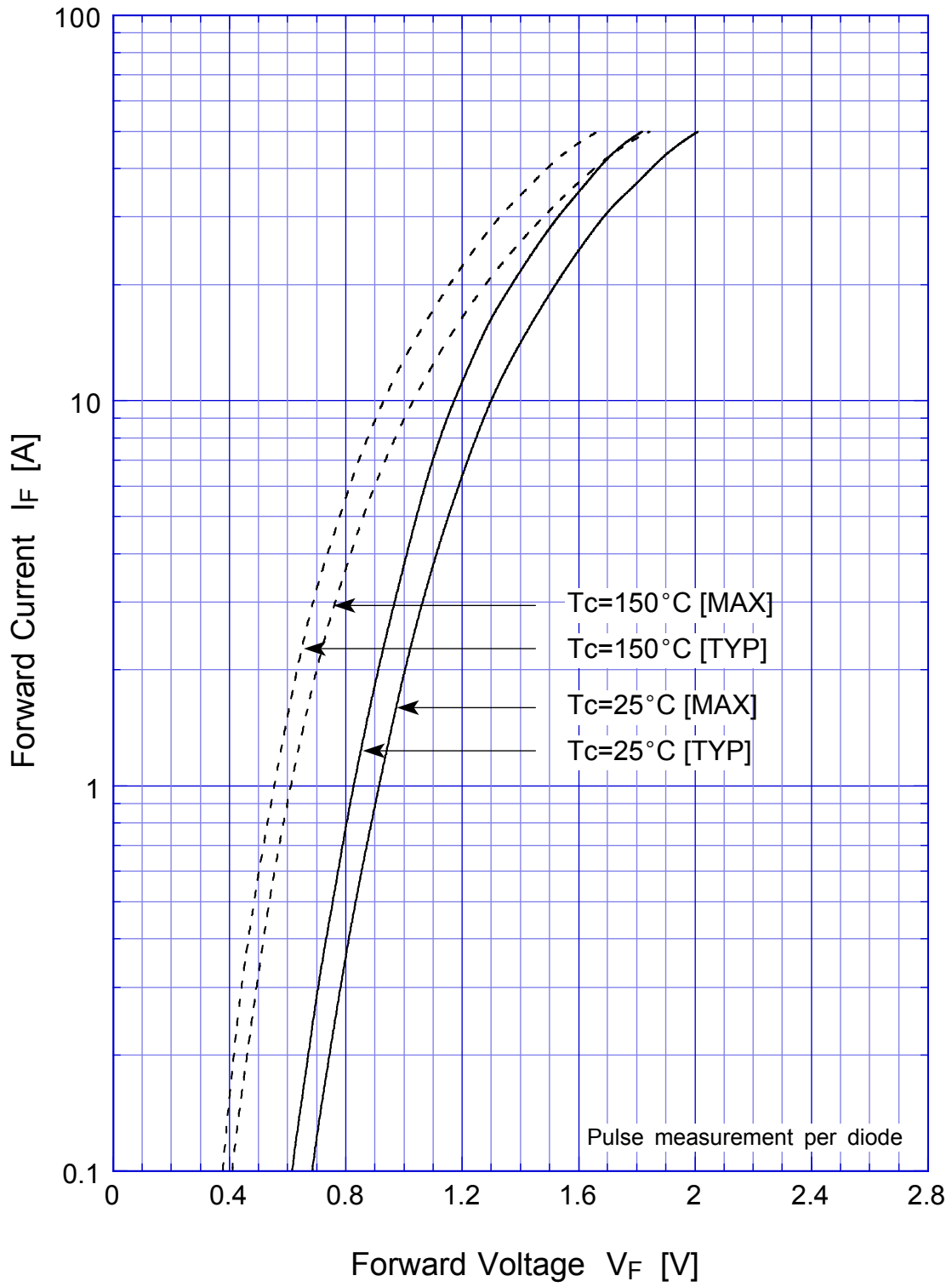

D20LC40 Forward Power Dissipation

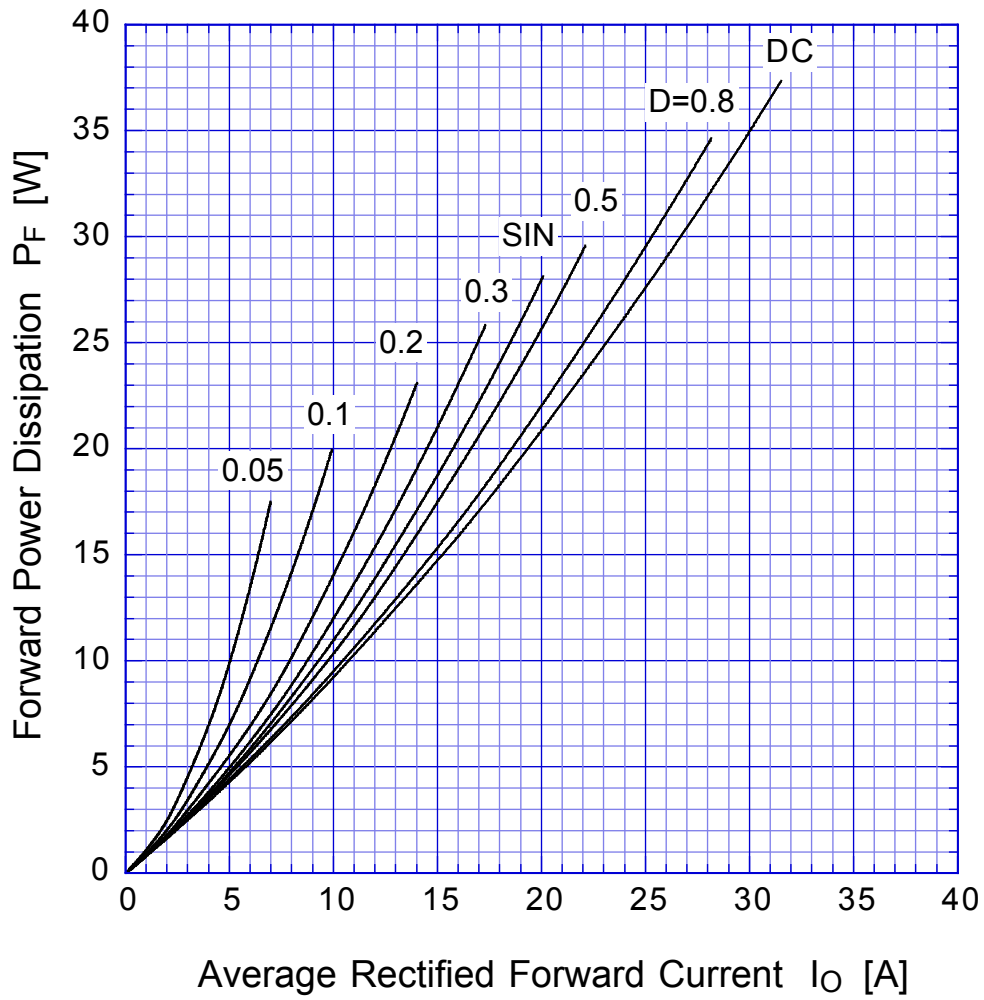

$T_j = T_{jmax}$

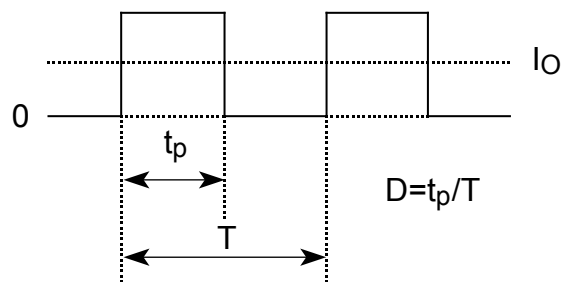

D20LC40

Derating Curve

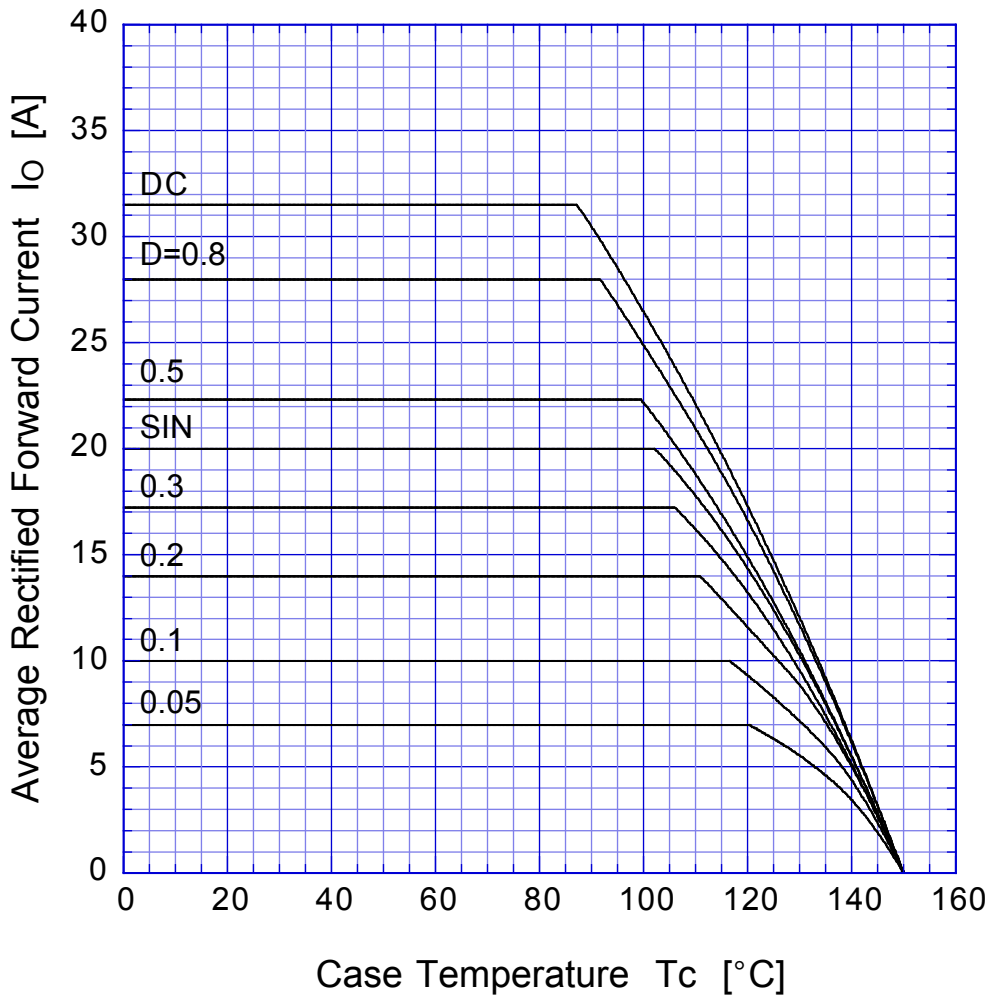

$$V_R = V_{RM}$$

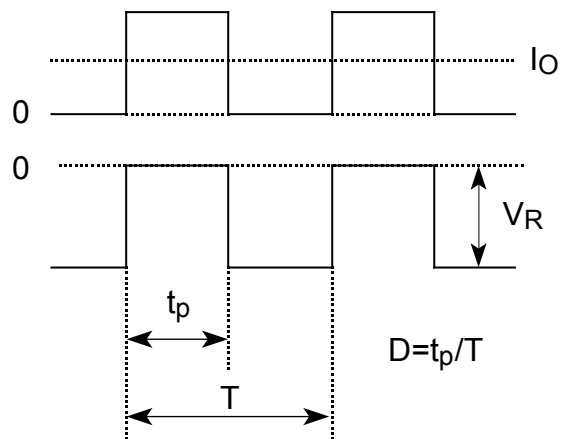

D20LC40

Peak Surge Forward Capability

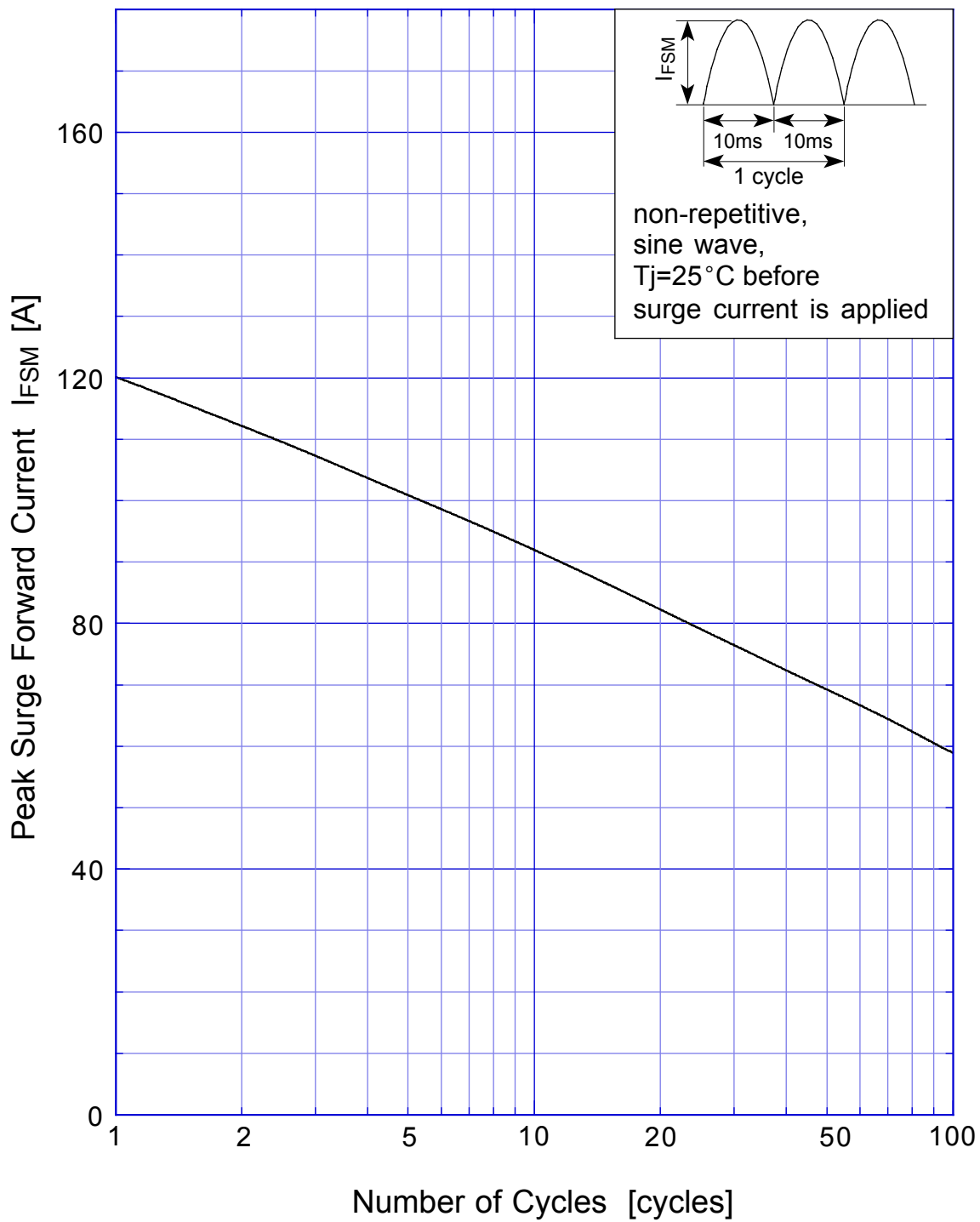

D20LC40 Junction Capacitance

