



ANALOG DEVICES

Integrated Circuit Multiplier, Divider, Squarer, Square Rooter

AD530

FEATURES

- Totally Self-Contained Multiplier, Divider, Squarer, Square Rooter
- Guaranteed $\pm 0.5\%$ Max 4-Quadrant Accuracy (AD530L)
- Guaranteed Accuracy Performance Over Temperature... $\pm 1.5\%$ Max (AD530L)
- High Speed
 - f_t1MHz
 - f_p750kHz
 - Slew Rate.....45V/ μ sec Typ
- Fully Protected Inputs and Output
- Low Cost: \$15.00 (100's, J)

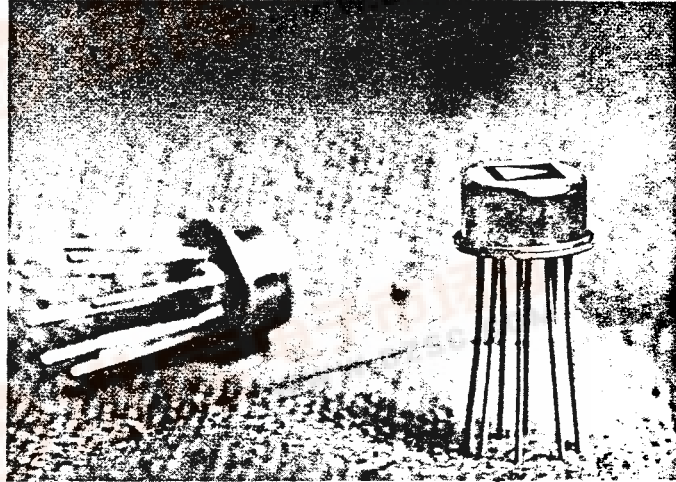

PRODUCT DESCRIPTION

The Analog Devices AD530 is the industry's first integrated circuit multiplier to include the transconductance multiplying element, stable reference, and output amplifier on a monolithic silicon chip. The AD530 multiplies in four (4) quadrants with a transfer function of $XY/10$, divides in two (2) quadrants with $10Z/X$ transfer function, and square roots in one (1) quadrant with a transfer function of $-\sqrt{10Z}$.

The AD530's guaranteed accuracy, overall high performance, and ease of use compare favorably with modular multipliers, and its IC construction provides significant advantages in size, reliability and economy. The AD530J, AD530K and AD530L are specified for maximum multiplying errors of 2%, 1% and 0.5% respectively at +25°C, which includes the effects of offset voltage, feedthrough, scale factor, and non-linearity in all four (4) quadrants. The AD530S is guaranteed for a maximum 1% multiplying error at +25°C.

Both the AD530L and AD530S are 100% temperature tested and guaranteed to have errors of less than $\pm 1.5\%$ and $\pm 3\%$ respectively over their specified temperature ranges of 0°C to +70°C and -55°C to +125°C.

The AD530 is a major step ahead of other IC multipliers which require the user to complete the function by providing the output amplifier, frequency compensation, level shifting, scaling and parasitic suppression circuitry, and considerable design expertise. The circuit's complement of external components is confined to feedthrough, output zero and gain adjusting trim pots.

The devices offer excellent ac performance, with typical small signal bandwidth of 1.0MHz, full power bandwidth of 750kHz and slew rate of 45V/ μ sec. The op amp output provides ± 10 volts at 5mA, and is fully protected against short circuits to ground or either supply voltage; all inputs are fully protected against over-voltage transients with internal series resistors.

The AD530J, AD530K and AD530L are available in the hermetically sealed TO-100 metal can and TO-116 ceramic DIL packages, and are specified for operation from 0°C to +70°C. The AD530S, available in the same packages, is specified for operation from -55°C to +125°C.

GUARANTEED PERFORMANCE OVER TEMPERATURE
100% Drift Testing of the AD530L and AD530S provides the user with *maximum* error limits previously available only in higher priced modular multipliers. Each AD530L and AD530S is tested at its extreme temperature limits (0°C and +70°C for the L version, -55°C and +125°C for the S version), as well as room temperature (+25°C). This process allows ADI to guarantee that the *maximum* error of the AD530L is $\pm 1.5\%$ (0°C to +70°C) and the *maximum* error of the AD530S is $\pm 3.0\%$ (-55°C to +125°C).

S-8

001467

Original

T 1467

ANA

9/72



1CL 8013

SPECIFICATIONS (typical @ +25°C, externally trimmed and ±15VDC unless otherwise specified)

PARAMETER	CONDITIONS	AD530J	AD530K	AD530L	AD530S
MULTIPLIER SPECIFICATIONS					
Transfer Function	untrimmed	XY/10 XY/6 max [XY/10 min]	*	*	*
Total Error	$T_A = \text{min to max}$	±2.0% max [±1.5% typ]	±1.0% max [±0.7% typ]	±0.5% max [±0.3% typ]	±1.0% max [±0.5% typ]
vs. Temperature	$T_A = \text{min to max}$	±2.5% ±0.04%/°C	±1.5% ±0.03%/°C	±1.5% max ±0.01%/°C	±3.0% max ±0.02%/°C max [±0.01%/°C typ]
Nonlinearity					
X input	$V_x = V_o = 20V(p-p)$	±0.8%	±0.5%	±0.3%	±0.5%
Y input	$V_y = V_o = 20V(p-p)$	±0.3%	±0.2%	±0.2%	±0.2%
Feedthrough					
X input	$V_x = 20V(p-p), V_y = 0, f = 50Hz$	150mV(p-p) max [50mV(p-p) typ]	80mV(p-p) max [30mV(p-p) typ]	40mV(p-p) max [20mV(p-p) typ]	80mV(p-p) max [30mV(p-p) typ]
Y input	$V_y = 20V(p-p), V_x = 0, f = 50Hz$	100mV(p-p) max [30mV(p-p) typ]	60mV(p-p) max [25mV(p-p) typ]	30mV(p-p) max [15mV(p-p) typ]	60mV(p-p) max [25mV(p-p) typ]
vs. Temperature	$T_A = \text{min to max}$	2.0mV(p-p)/°C	1.0mV(p-p)/°C	0.5mV(p-p)/°C	1.0mV(p-p)/°C
DIVIDER SPECIFICATIONS					
Transfer Function	untrimmed	10Z/X 10Z/X max [6Z/X min]	*	*	*
Total Error	$V_x = -10VDC, V_z = \pm 10VDC$ $V_x = -1VDC, V_z = \pm 10VDC$	±1.0% ±3.0%	±0.5% ±2.0%	±0.2% ±1.5%	±0.5% ±2.0%
SQUARER SPECIFICATIONS					
Transfer Function	untrimmed	$X^2/10$ $X^2/6$ max [$X^2/10$ min]	*	*	*
Total Error		±0.8%	±0.4%	±0.2%	±0.4%
SQUARE ROOTER SPECIFICATIONS					
Transfer Function	untrimmed	$-\sqrt{10Z}$ $-\sqrt{10Z}$ max [$-\sqrt{6Z}$ min]	*	*	*
Total Error		±0.8%	±0.4%	±0.2%	±0.4%
INPUT SPECIFICATIONS					
Input Resistance					
X input		10MΩ	*	*	*
Y input		6MΩ	*	*	*
Z input		36kΩ	*	*	*
Input Bias Current					
X, Y inputs		3μA	4μA max [1.5μA typ]	2μA max [1μA typ]	4μA max [1.5μA typ]
Z input		±10μA	±15μA max [±5μA typ]	**	**
X, Y inputs	$T_A = \text{min to max}$	10μA	8μA	4μA	8μA
Z input	$T_A = \text{min to max}$	±30μA	±25μA	**	**
Input Voltage	$T_A = \text{min to max}$				
V_x, V_y, V_z	for rated accuracy	±10V	*	*	*
Null Input Voltage	required to trim				
V_{xo}, V_{yo}, V_{zo}		±15V max [±5V typ]	±10V max [±3V typ]	**	**
DYNAMIC SPECIFICATIONS					
Small Signal, Unity Gain		1.0MHz	*	*	*
Full Power Bandwidth		750kHz	*	*	*
Slew Rate		45V/μsec	*	*	*
Small Signal Amplitude Error		1% at 75kHz	*	*	*
Small Signal 1% Vector Error	0.5° phase shift	5kHz	*	*	*
Settling Time	±10V step	1μsec to 2%	*	*	*
Overload Recovery		2μsec to 2%	*	*	*
OUTPUT AMPLIFIER SPECIFICATIONS					
Output Impedance		100Ω	*	*	*
Output Voltage Swing	$T_A = \text{min to max}$ $R_L \geq 2k\Omega, C_L \leq 1000pF$	±10V min [±13V typ]	*	*	*
Output Noise	$f = 5Hz$ to 10kHz $f = 5Hz$ to 5MHz	0.6mV(rms) 3.0mV(rms)	*	*	*
Output Offset Voltage		trimmable to zero	*	*	*
vs. Temperature	$T_A = \text{min to max}$	0.7mV/°C	0.7mV/°C	1.0mV/°C max	2.0mV/°C max
POWER SUPPLY SPECIFICATIONS					
Supply Voltage	rated performance operating quiescent	±15V ±15V to ±18V ±6mA max [±4mA typ]	*	*	*
Supply Current	includes effects of recommended null pots		±10V to ±18V	±10V to ±18V	±10V to ±22V
Power Supply Variation			*	*	*
Multiplier Accuracy		±0.5%/%	*	*	*
Output Offset		±10mV/°	*	*	*
Scale Factor		±0.1%/%	*	*	*
Feedthrough		±10mV/°	*	*	*

*Specifications same as AD530J.

**Specifications same as AD530K.

Specifications subject to change without notice.

APPLICATIONS

- Multiplying, Dividing, Squaring, Square Rooting
- Modulating and Demodulating
- Frequency Discrimination
- RMS Computation
- Phase Detection
- Automatic Gain Control
- Peak Detection
- Signal Correlation
- Voltage-Controlled Oscillators & Filters
- Function Generation
- Power Measurements

For more detailed applications information, please refer to Analog Devices' AD530 Technical Bulletin, and Multiplier Handbook.

AD530 SCHEMATIC DIAGRAM

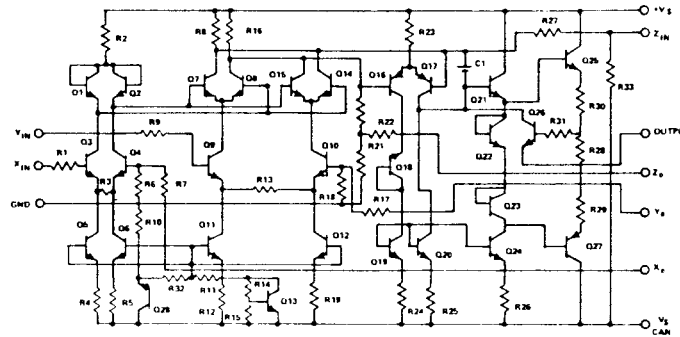

PIN CONFIGURATION & DIMENSIONS

**AD530H
TO-100**

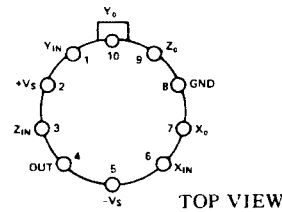
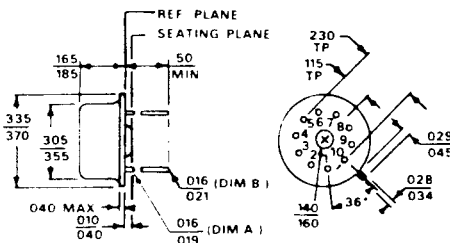

**AD530D
TO-116**

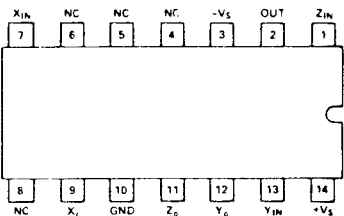
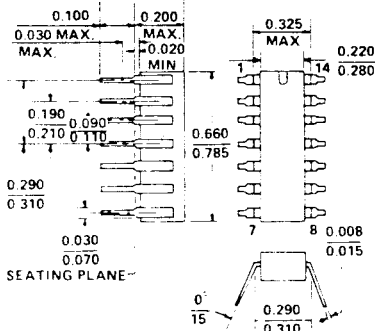

FUNCTIONAL DESCRIPTION

The AD530 can be represented in block diagram form as shown in Figure 1. The X and Y inputs are each fed into one input of a differential amplifier and the associated null voltage, derived from external pots, is fed to the other input to cancel any offset voltage present. The product of the two inputs is formed in the multiplier section using Gilbert's Linearized Transconductance technique. The scale factor, K, is typically 8, which allows adjusting for an XY/10 transfer function by attenuating one of the two inputs. An operational amplifier is included to produce a low impedance output and make possible self-contained operation. Offset voltage in the op amp is nulled by introducing a voltage into the Z₀ input.

The Z input is used to close the loop around the op amp when in the multiplier or squarer modes and is used as a signal input for divide or square root operation.

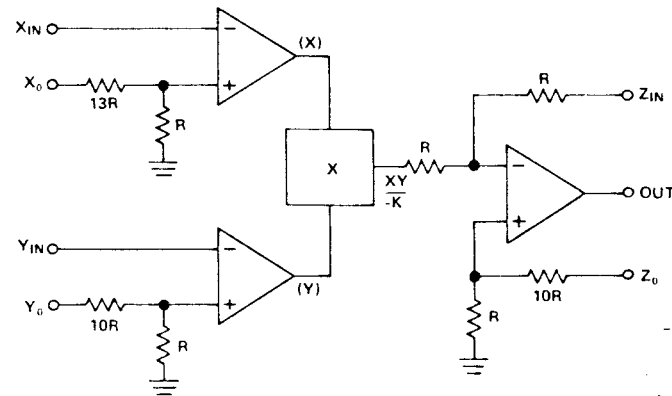
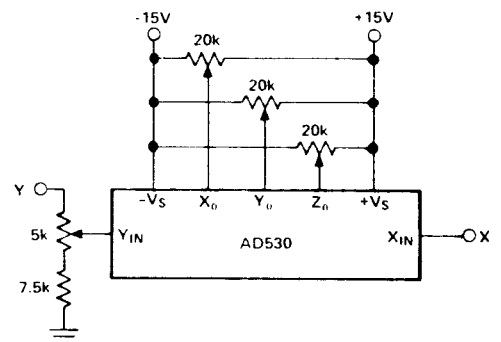

Figure 1. AD530 Functional Diagram.



MULTIPLIER

Multiplier operation is accomplished by closing the loop around the internal op amp with the Z input connected to the output. The X_0 null pot balances the X input channel to minimize Y feedthrough and similarly the Y_0 pot minimizes the X feedthrough. The Z_0 pot nulls the output op amp offset voltage and the gain pot sets the full scale output level.

Using the recommended trim procedure will insure meeting the specified accuracy in all four quadrants with ± 10 volt full scale signal levels. Higher accuracy is achievable if the application allows operation in only 1 or 2 quadrants and the null adjustments are optimized accordingly. Reducing the full scale signal amplitudes also improves 25°C accuracy; however, the limit of this approach is reached when device noise, V_{OS} temperature drift and feedthrough begin to dominate.

SQUARER

Squarer operation is a special case of multiplier operation where the X and Y inputs are connected together and two quadrant operation results since the output is always positive. When the X and Y inputs are connected together, a composite offset results which is the algebraic sum of the individual offsets which can be nulled using the X_0 pot alone.

The squarer is capable of better accuracy than the multiplier since operation is optimized for two quadrants and feedthrough errors do not exist. A $\pm 2\%$ multiplier will typically square to better than $\pm 1\%$ of full scale.

DIVIDER

The divide mode utilizes the multiplier in a fed-back configuration where the Y input now controls the feedback factor. With X = full scale, the gain (V_O/Z) becomes unity after trimming. Reducing the X input reduces the feedback around the op amp by a like amount, thereby increasing the gain. This reciprocal relationship forms the basis of the divide mode. As X approaches zero, the circuit gain approaches the open loop gain of the op amp producing a proportional degradation in accuracy, noise and frequency response, limiting the usable dynamic range.

The divide mode error from all sources is related to the basic multiplier error by the relationship $\epsilon_d \cong 10\epsilon_m/X$. This shows that as X approaches zero, the divide error, when trimmed as a multiplier, can become quite large. However, since the divider is limited in operation to 2 quadrants, the trim procedure was devised to minimize this error over a 10/1 range in X, thus achieving far better results than the above relation suggests (see divide specs, page 2).

SQUARE ROOTER

This mode is also a fed-back configuration with both the X and Y inputs tied to the op amp output through an external diode to prevent latchup. In this case, the amount of negative feedback is proportional to the square of the output voltage. Likewise, the Z input must be proportional to the square of the output at equilibrium, which is the square root function. Accuracy, noise and frequency response are proportional to \sqrt{Z} , which implies a wider usable dynamic range than the divide mode. The trim procedure has been optimized to minimize average error over a range of Z inputs, taking advantage of the fact that no feedthrough error terms exist and the output is always negative. The resultant accuracy in the square root mode is typically twice that achievable in the 4-quadrant multiplier mode.

TRIM PROCEDURES

Multiplier.....

1. With X = Y = 0 volts, adjust Z_0 for 0VDC output.
2. With Y = 20 volts p-p (at f = 50Hz) and X = 0V, adjust X_0 for minimum ac output.
3. With X = 20 volts p-p (at f = 50Hz) and Y = 0V, adjust Y_0 for minimum ac output.
4. Readjust Z_0 for 0VDC output.
5. With X = +10VDC and Y = 20 volts p-p (at f = 50Hz), adjust gain for output = Y_{in} .

NOTE: For best accuracy over limited voltage ranges (e.g., $\pm 5V$), gain and feedthrough adjustments should be optimized with the inputs in the desired range. When so optimized, the error may be greater over the specified ($\pm 10V$) range. However, linearity is considerably better over smaller ranges of input.

Squarer.....

1. With X = 0 volts, adjust Z_0 for 0VDC output.
2. With X = +10VDC, adjust gain for +10VDC output.
3. Reverse polarity of X input and adjust X_0 to reduce the output error to $\frac{1}{2}$ its original value, then readjust the gain to take out the remaining error.
4. Check the output offset with input grounded. If non-zero, repeat the above procedure until no errors remain.

Divider.....

1. Set all pots at mid-scale.
2. With Z = 0V, trim Z_0 to hold the output constant, as X is varied from -10VDC through -1VDC.
3. With Z = 0V, X = -10VDC, trim Y_0 for 0VDC.
4. With Z = X and/or Z = -X, trim X_0 for the minimum worst-case variation as X is varied from -10VDC to -1VDC.
5. Repeat steps 2 and 3 if step 4 required a large initial adjustment.
6. With Z = X and/or Z = -X, trim the gain for the closest average approach to $\pm 10VDC$ output as X is varied from -10VDC to -3VDC.

Square Rooter.....

1. With Z = +0.1VDC, adjust Z_0 for Output = -1.0VDC.
2. With Z = +10.0VDC, adjust Gain for Output = -10.0VDC.
3. With Z = +2.0VDC, adjust X_0 for Output = -4.47 $\pm 0.1VDC$.
4. Repeat steps 2 and 3, if necessary.
5. Repeat step 1.

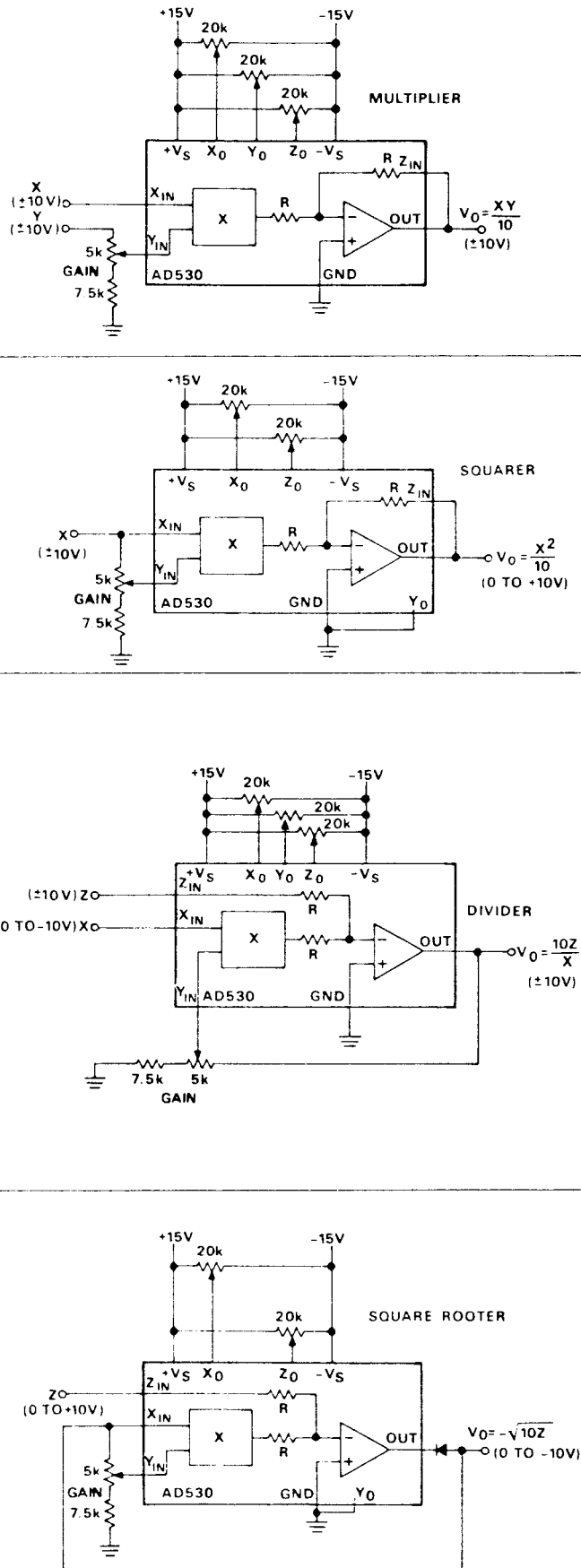

USER'S GUIDE TO MULTIPLIER SPECIFICATIONS

There are no established standards for multiplier specifications and little correlation between the definitions used by various manufacturers of these products. Further complicating the problem is the fact that multiplier accuracy is a function of two inputs, rather than one as with op amps. Therefore, we review here the definitions of multiplier specifications used by Analog Devices, and also interpret these specifications in terms of practical applications. Dynamic response and factors affecting multiplier accuracy are the most important and least understood specifications, and will be given primary attention.

A clear understanding of the various error sources of the AD530 will assist the user in obtaining optimum performance under his particular operating conditions. The principle sources of error are feedthrough, nonlinearity, output offset, and scale factor (gain). In addition, the effects of variations in power supply voltage, operating frequency, and temperature on these error terms must be considered.

FEEDTHROUGH

Ideally, in the multiplier configuration with one input at zero, the output should be zero, regardless of the signal applied to the other input. Actually, however, a small output signal will be present. This error is defined as feedthrough and is measured at low frequency (50Hz) for the conditions $X_{in} = 0$, $Y_{in} = 20V(p-p)$ and $Y_{in} = 0$, $X_{in} = 20V(p-p)$.

Feedthrough is composed of two components, one of which can be trimmed to zero with two external null pots. In the case of Y feedthrough, this component is simply the dc offset of the X channel being multiplied by the Y input signal. Nulling is accomplished by introducing an opposing offset voltage into the alternate input of the X differential amplifier by means of the X_0 pot. Similarly, any dc offset in the Y input channel produces X feedthrough and is trimmed out by the Y_0 null pot. An untrimmable component remains due to the nonlinearity of the multiplier cell, and is the value shown in the electrical specifications. Figure 3 shows typical X or Y feedthrough before and after nulling.

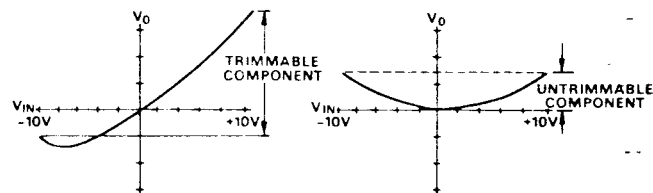

Figure 3. Typical X or Y Feedthrough Before and After Nulling.

At high frequencies, the circuit acts as if there were capacitive coupling between each input and the output. Therefore, at some corner frequency, feedthrough will rise with increasing frequency at 6dB/octave as illustrated in Figure 4, until other shunt capacitance begins to attenuate this effect. This high frequency feedthrough will primarily consist of the fundamental component and will vary in proportion to the

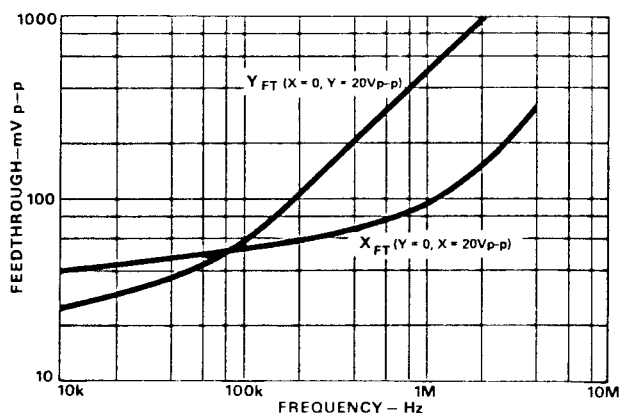

Figure 4. Typical Feedthrough vs. Frequency.

The low frequency feedthrough of the Y input is inherently lower than that of the X input, and should be used for the input whose feedthrough is to be minimized. A further reduction of feedthrough can be achieved by decreasing the input signal amplitude; for example, reducing the amplitude by a factor of two reduces the feedthrough by approximately a factor of four.

Ambient temperature variations cause small drifts in dc offsets which produce fundamental component feedthrough. The resulting effect is the same as if the X_O and Y_O adjustments were slightly misadjusted.

OUTPUT OFFSET

An ideal multiplier would have zero output when both input signals are zero. Output offset is the error defined as the dc output signal when $X_{in} = Y_{in} = 0$. This error obviously has the greatest percentage effect on accuracy for low level output signals. An external trimming pot is used with the AD530 to adjust the initial offset to zero. Output offset drift with temperature and supply voltage variations becomes the limit in accuracy for low level dc output signals.

SCALE FACTOR

The scale factor is essentially the gain of the multiplier and is represented as $1/K$ in the transfer function; i.e., $V_O = XY/K$. The magnitude and stability of K are determined by an internal temperature-compensated reference current source and stable thin-film resistors deposited on the chip. K is typically 8 and, in most applications, is adjusted to 10 by means of an external attenuator on the X or Y input.

Scale factor error can be trimmed to zero in any one quadrant at full scale; however, due to nonlinearities, the scale factor will vary slightly from quadrant to quadrant. Therefore, the best way to trim the scale factor is to trim for minimum average error in the quadrants of interest.

NONLINEARITY

While errors due to output offset, feedthrough and scale factor can be substantially reduced by external adjustments, nonlinearity remains as a basic irreducible limitation to achievable accuracy. Nonlinearity is measured by applying a full scale dc signal to one input and a low frequency sinewave with full scale peak-to-peak amplitude to the other. The ac output is then nulled against the ac input and the scale factor is adjusted for minimum error voltage. The reduced peak-to-peak voltage is then a measure of nonlinearity referred to a best

Total harmonic distortion at low frequencies is another way of measuring and specifying nonlinearity, and is identical with the dc nonlinearity on a peak-to-peak basis as described above. Output distortion consists primarily of second and third harmonics. Typical curves of nonlinearity for the X and Y inputs are shown below. In general, linearity error is small near zero and increases rapidly near full scale.

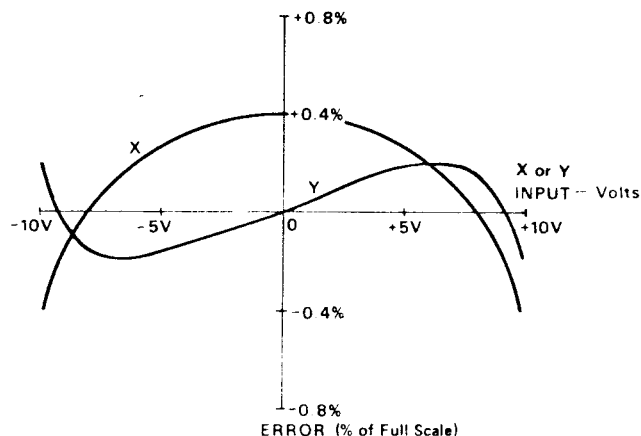

Figure 5. Typical X and Y Non-Linearity.

By taking advantage of nonlinearity specifications, you can (1) often use a less-costly multiplier to obtain adequate small-signal accuracy, and (2) determine which input to use for best accuracy, if one of the input signals has a small range of variation.

The way to do this is to use the nearly-always-conservative approximation: $f(x, y) \cong |x| \epsilon_x + |y| \epsilon_y$, where ϵ_x and ϵ_y are the fractional nonlinearities specified for the x and y inputs.

EXAMPLE: For the Model AD530K, $\epsilon_x = 0.5\%$, $\epsilon_y = 0.2\%$. What maximum error can I expect for $x = 5V$, $y = 1V$? Can I get less by interchanging inputs?

- Nominal output is $xy/10 = (5)(1)/10 = 500mV$.
- Expected error is $(5)(0.005) + (1)(0.002) = 27mV$, 5.4% of output (0.27% F.S.).
- Interchanging inputs, $(1)(0.005) + (5)(0.002) = 15mV$, 3.0% of output (0.15% F.S.).

Compare this with the overly-conservative error predicted by the overall 1%-of-full-scale specification: 100mV, or 20% of output!!

Nonlinearity is relatively independent of temperature variation and its contribution to total error can be considered constant over the specified operating range.

MULTIPLICATION ACCURACY

One can see from the foregoing discussion that to specify overall multiplier accuracy is not a simple matter. Moreover, the errors that are significant will vary from one application to the next depending on whether the signals are ac or dc, or a combination thereof. Each error source is independently specified, but some of the errors actually cancel each other when they are combined. Therefore, perhaps an RMS sum of the pertinent errors will give a better indication of overall

For applications where two dc input signals are multiplied to obtain an output product, the best way to specify accuracy is to combine all of the errors and specify a total combined dc error, which we define as dc multiplication accuracy. To measure the combined dc error, one constructs a matrix by recording the output voltage for various combinations of input voltage throughout the input voltage range. The total error is determined by comparing the actual readings to the ideal output computed by $V_O = XY/10$.

While dc multiplication accuracy is the most convenient and least ambiguous specification of errors, it has been a consuming and, therefore, expensive test to perform. However, a completely automated test system enables Analog Devices to economically 100% test accuracy at 25°C. It is even more expensive to test and guarantee multiplication accuracy over temperature; the AD530L and AD530S representing the *only* IC multipliers to guarantee accuracy over temperature. For these devices, tests as described are performed at room temperature as well as at elevated temperatures with 25°C null settings, and a worst case total error is measured.

DYNAMIC CHARACTERISTICS

The closed loop frequency response of the AD530 in the multiplier mode typically exhibits a 3dB bandwidth of 1MHz and rolls off at 6dB/octave thereafter, governed by the output op amp internal compensation. Response through the X or Y input is essentially identical and is shown in Figure 6 below.

Stable operation is maintained with a capacitive load of up to 1000pF in all modes, except the square rooter, where 50pF is a safe limit to prevent oscillation or ringing. Higher capacitive loads can be driven if a 100Ω resistor in series with the output is included for isolation.

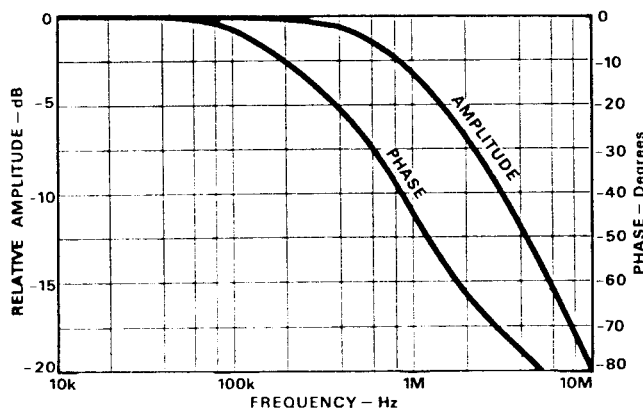

Figure 6. Typical Closed Loop Frequency and Phase Response of Multiplier.

In the divide mode, the amount of negative feedback varies with signal amplitude as previously discussed. Consequently, the amplitude range of the X input is critical in determining the worst case frequency response. This dependence is shown

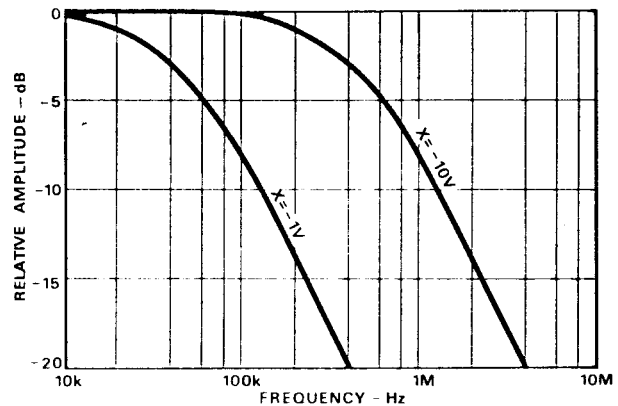

Figure 7. Typical Divide Mode Frequency Response

For some applications, the instantaneous (sometimes called the absolute) error between the output and input signals may be of primary concern. In this case, vector errors due to phase shift accumulate much more rapidly as a function of frequency than do amplitude or scaler errors. This follows since a phase shift of only 0.57° will cause a vector error of 1%, whereas the amplitude error is only 0.005% at this phase shift. The relationship between these errors is illustrated in the vector diagram of Figure 8.

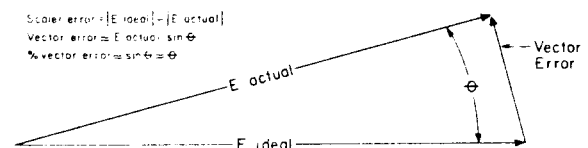

Figure 8. Relationship of Dynamic Errors

POWER SUPPLY CONSIDERATIONS

Although the AD530 is tested and specified with ±15 volt supplies, the K and L versions may be operated at any supply voltage from ±10V to ±18V and the S version from ±10V to ±22V with little affect on overall performance. The input and output signals must be reduced proportionately to prevent

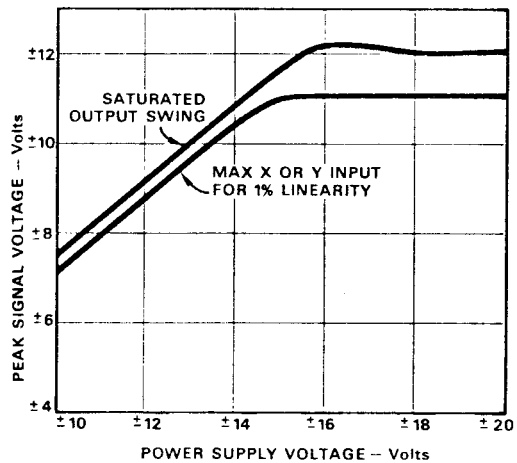
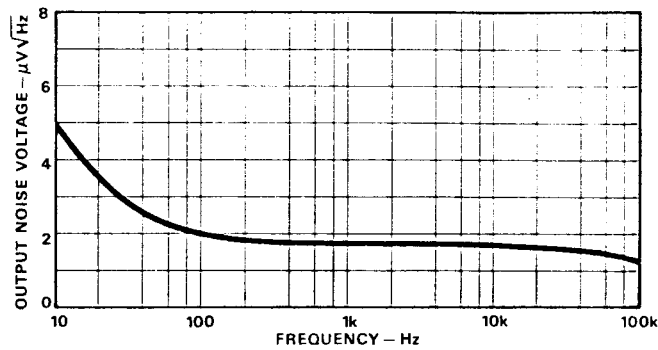

Figure 9. Typical Allowable Signal Swing vs. Supply Voltage

Power supply rejection figures are specified for accuracy, feedthrough, output offset and scale factor to enable the user to determine supply regulation requirements commensurate with his operating conditions. All the specifications include effects of the recommended null pots.

NOISE CHARACTERISTICS

All AD530's are screened on a sampling basis, both at the wafer stage and at final test, to assure that output noise will have no appreciable effect on accuracy. Typical spot noise vs. frequency characteristics are shown in Figure 10.



BONDING DIAGRAM

The AD530 is available in chip or wafer form, fully tested at 25°C. Because of the critical nature of using unpackaged devices, it is suggested that the factory be contacted for specific information regarding price, delivery and testing.

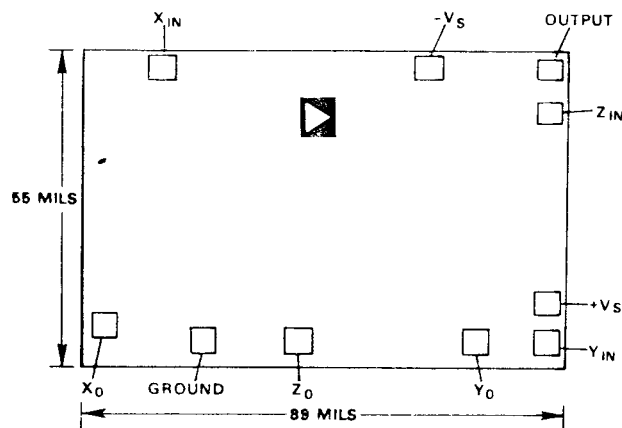

ORDERING GUIDE

*Add Package Type Letter

MODEL	MULT. ERROR	TEMP. RANGE	ORDER NUMBER	PRICE (1-24)	PRICE (25-99)	PRICE (100-999)
AD530J	±2.0%	0°C to +70°C	AD530J*	\$22.50	\$18.00	\$15.00
AD530K	±1.0%	0°C to +70°C	AD530K*	\$33.50	\$27.00	\$22.50
AD530L	±0.5%	0°C to +70°C	AD530L*	\$45.00	\$36.00	\$27.50
AD530S	±1.0%	-55°C to +125°C	AD530S*	\$51.00	\$41.00	\$34.00
AD530S/883	±1.0%	-55°C to +125°C	AD530S*/883	\$63.00	\$50.00	\$42.00

Prices subject to change. Refer to latest Microcircuit Price List.