



2.7 V to 5.5 V, <100 μ A, 8-/10-/12-Bit *nano*DAC™ D/A, SPI® Interface, SC70 Package

Preliminary Technical Data

AD5601/AD5611/AD5621

FEATURES

- 6-lead SC70 package
- Power-down to <100 nA @ 3 V
- Micropower operation: max 100 μ A @ 5 V
- 2.7 V to 5.5 V power supply
- Guaranteed monotonic by design
- Power-on reset to 0 V with brownout detection
- 3 power-down functions
- Low power serial interface with Schmitt-triggered inputs
- On-chip output buffer amplifier, rail-to-rail operation
- SYNC interrupt facility
- Minimized zero code error
- AD5601 buffered 8-bit DAC in SC70:
 - B Version: ± 0.5 LSB INL
- AD5611 buffered 10-bit DAC in SC70:
 - B Version: ± 0.5 LSB INL
 - A Version: ± 4 LSB INL
- AD5621 buffered 12-bit DAC in SC70:
 - B Version: ± 1 LSB INL
 - A Version: ± 6 LSB INL

APPLICATIONS

- Voltage level setting
- Portable battery-powered instruments
- Digital gain and offset adjustment
- Programmable voltage and current sources
- Programmable attenuators

GENERAL DESCRIPTION

The AD5601/AD5611/AD5621, members of the *nano*DAC family, are single, 8-/10-/12-bit, buffered, voltage out DACs that operate from a single 2.7 V to 5.5 V supply, consuming <100 μ A at 5 V. The parts come in a tiny SC70 package. Their on-chip precision output amplifier allows rail-to-rail output swing to be achieved. The AD5601/AD5611/AD5621 utilize a versatile 3-wire serial interface that operates at clock rates up to 30 MHz and is compatible with SPI®, QSPI™, MICROWIRE™, and DSP interface standards.

The reference for the AD5601/AD5611/AD5621 is derived from the power supply inputs and, therefore, gives the widest dynamic output range. The parts incorporate a power-on reset circuit, which ensures that the DAC output powers up to 0 V and remains there until a valid write to the device takes place.

FUNCTIONAL BLOCK DIAGRAM

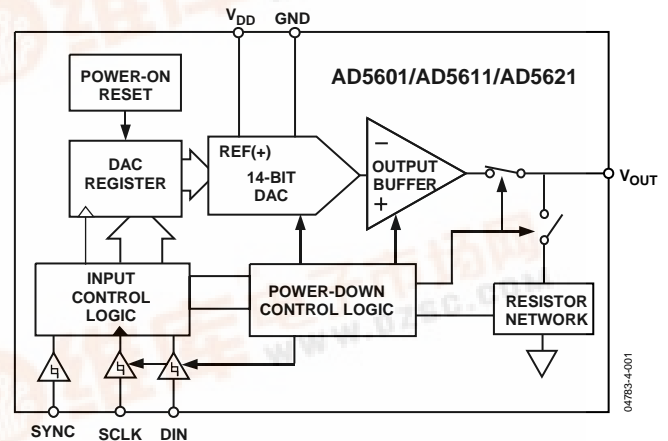

Figure 1.

Table 1. Related Devices

Part Number	Description
AD5641	2.7 V to 5.5 V, <100 μ A, 14-Bit, <i>nano</i> DAC D/A, tiny SC70 Package

The AD5601/AD5611/AD5621 contain a power-down feature that reduces current consumption to <100 nA at 3 V, and provides software-selectable output loads while in power-down mode. The parts are put into power-down mode over the serial interface. The low power consumption of these parts in normal operation makes them ideally suited to portable battery-operated equipment. The combination of small package and low power makes these *nano*DAC devices ideal for level-setting requirements such as generating bias or control voltages in space-constrained and power-sensitive applications.

(continued on Page 3)



TABLE OF CONTENTS

Product Highlights	3	Input Shift Register	13
Specifications.....	4	$\overline{\text{SYNC}}$ Interrupt	14
Timing Characteristics	5	Power-On Reset	14
Absolute Maximum Ratings.....	6	Power-Down Modes	14
ESD Caution.....	6	Microprocessor Interfacing.....	14
Pin Configuration and Function DescriptionS	7	Applications.....	16
Terminology	8	Choosing a Reference as Power Supply for AD5601/AD5611/AD5621	16
Typical Performance Characteristics	9	Bipolar Operation Using the AD5601/ AD5611/AD5621	16
General Description	13	Using AD5601/AD5611/AD5621 with an Opto-Isolated Interface.....	17
D/A Section	13	Power Supply Bypassing and Grounding.....	17
Resistor String.....	13	Outline Dimensions	18
Output Amplifier.....	13	Ordering Guide	18
Serial Interface	13		

REVISION HISTORY

Revision PrC: Preliminary Version

PRODUCT HIGHLIGHTS

1. Available in a space-saving 6-lead SC70 package.
2. Low power, single-supply operation. The AD5601/AD5611/AD5621 operate from a single 2.7 V to 5.5 V supply and typically consume 0.2 mW at 3 V and 0.5 mW at 5 V, making them ideal for battery-powered applications.
3. The on-chip output buffer amplifier allows the output of the DAC to swing rail-to-rail with a typical slew rate of 0.5 V/ μ s.
4. Reference derived from the power supply.
5. High speed serial interface with clock speeds up to 30 MHz.
6. Designed for very low power consumption. The interface powers up only during a write cycle.
7. Power-down capability. When powered down, the DAC typically consumes <100 nA at 3 V.

SPECIFICATIONS

$V_{DD} = 2.7\text{ V to }5.5\text{ V}$; $R_L = 2\text{ k}\Omega\text{ to GND}$; $C_L = 200\text{ pF to GND}$; all specifications T_{MIN} to T_{MAX} , unless otherwise noted.

Table 2.

Parameter	B Version ¹			Unit	Test Conditions/Comments
	Min	Typ	Max		
STATIC PERFORMANCE					
AD5601					
Resolution	8			Bits	
Relative Accuracy ²			± 0.5	LSB	B Grade
Differential Nonlinearity ²			± 1	LSB	Guaranteed monotonic by design
AD5611					
Resolution	10			Bits	
Relative Accuracy ²			± 0.5	LSB	B Grade
			± 4.0	LSB	A Grade
Differential Nonlinearity ²			± 1	LSB	Guaranteed monotonic by design
AD5621					
Resolution	12			Bits	
Relative Accuracy ²			± 1	LSB	B Grade
			± 6	LSB	A Grade
Differential Nonlinearity ²			± 1	LSB	Guaranteed monotonic by design
Zero Code Error		± 0.2		mV	All 0s loaded to DAC register
Offset Error		± 0.125		% of FSR	
Full-Scale Error		± 0.01		LSB	All 1s loaded to DAC register
Gain Error		± 0.04		% of FSR	
Zero Code Error Drift		5.0		$\mu\text{V}/^\circ\text{C}$	
Gain Temperature Coefficient		2.0		ppm of FSR/ $^\circ\text{C}$	
OUTPUT CHARACTERISTICS ³					
Output Voltage Range	0		V_{DD}	V	
Output Voltage Settling Time		8	18	μs	Code $\frac{1}{4}$ to $\frac{3}{4}$
Slew Rate		0.5		V/ μs	
Capacitive Load Stability		470		pF	$R_L = \infty$
		1000		pF	$R_L = 2\text{ k}\Omega$
Output Noise Spectral Density		120		nV/Hz	DAC code = TBD, 10 kHz
Noise		TBD			DAC code = TBD, 0.1 Hz to 10 Hz bandwidth
Digital-to-Analog Glitch Impulse		10		nV-s	1 LSB change around major carry
Digital Feedthrough		0.5		nV-s	
DC Output Impedance		1			
Short-Circuit Current		20		mA	$V_{DD} = \pm 3\text{ V}/\pm 5\text{ V}$
LOGIC INPUTS					
Input Current			± 1	μA	
V_{INL} , Input Low Voltage	0.8			V	$V_{DD} = \pm 5\text{ V}$
	0.6			V	$V_{DD} = \pm 2.7\text{ V}$
V_{INH} , Input High Voltage			1.8	V	$V_{DD} = \pm 5\text{ V}$
			1.4	V	$V_{DD} = \pm 2.7\text{ V}$
Pin Capacitance		3		pF	

Parameter	B Version ¹			Unit	Test Conditions/Comments
	Min	Typ	Max		
POWER REQUIREMENTS					
V _{DD}	2.7		5.5	V	All digital inputs at 0 or V _{DD}
I _{DD} (Normal Mode)					DAC active and excluding load current
V _{DD} = ±4.5 V to ±5.5 V			100	μA	V _{IH} = V _{DD} and V _{IL} = GND
V _{DD} = ±2.7 V to ±3.6 V			70	μA	V _{IH} = V _{DD} and V _{IL} = GND
I _{DD} (All Power-Down Modes)					
V _{DD} = ±4.5 V to ±5.5 V		0.2	1	μA	V _{IH} = V _{DD} and V _{IL} = GND
V _{DD} = ±2.7 V to ±3.6 V		0.05	1	μA	V _{IH} = V _{DD} and V _{IL} = GND
POWER EFFICIENCY					
I _{OUT} /I _{DD}		TBD		%	I _{LOAD} = 2 mA and V _{DD} = ±5 V

¹ Temperature ranges are as follows: B Version: -40°C to +125°C, typical at +25°C.

² Linearity calculated using a reduced code range.

³ Guaranteed by design and characterization, not production tested.

TIMING CHARACTERISTICS

V_{DD} = 2.7 V to 5.5 V; all specifications T_{MIN} to T_{MAX}, unless otherwise noted. See Figure 2.

Table 3.

Parameter	Limit ¹	Unit	Test Conditions/Comments
t ₁ ²	33	ns min	SCLK cycle time
t ₂	13	ns min	SCLK high time
t ₃	12	ns min	SCLK low time
t ₄	13	ns min	SYNC to SCLK falling edge setup time
t ₅	5	ns min	Data setup time
t ₆	4.5	ns min	Data hold time
t ₇	0	ns min	SCLK falling edge to SYNC rising edge
t ₈	33	ns min	Minimum SYNC high time
t ₉	13	ns min	SYNC rising edge to next SCLK fall ignore

¹ All input signals are specified with tr = tf = 1 ns/V (10% to 90% of V_{DD}) and timed from a voltage level of (V_{IL} + V_{IH})/2.

² Maximum SCLK frequency is 30 MHz.

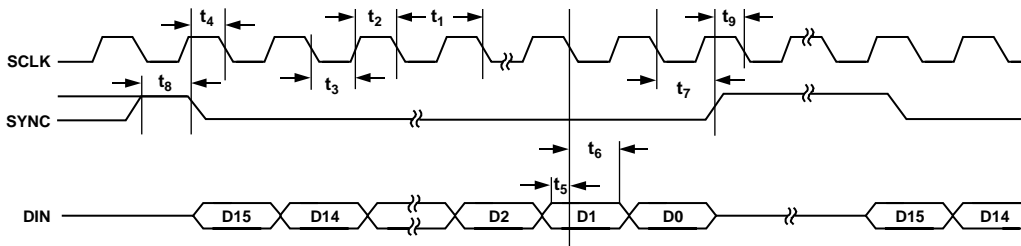

Figure 2. Timing Diagram

04783-C-002

ABSOLUTE MAXIMUM RATINGS

$T_A = 25^\circ\text{C}$, unless otherwise noted.

Table 4.

Parameter	Rating
V_{DD} to GND	-0.3 V to +7.0 V
Digital Input Voltage to GND	-0.3 V to $V_{DD} + 0.3$ V
V_{OUT} to GND	-0.3 V to $V_{DD} + 0.3$ V
Operating Temperature Range	
Industrial (B Version)	-40°C to +125°C
Storage Temperature Range	-65°C to +160°C
Maximum Junction Temperature	150°C
SC70 Package	
θ_{JA} Thermal Impedance	332°C/W
θ_{JC} Thermal Impedance	120°C/W
Lead Temperature, Soldering	
Vapor Phase (60 s)	215°C
Infrared (15 s)	220°C
ESD	2.0 kV

Stresses above those listed under Absolute Maximum Ratings may cause permanent damage to the device. This is a stress rating only; functional operation of the device at these or any other conditions above those listed in the operational sections of this specification is not implied. Exposure to absolute maximum rating conditions for extended periods may affect device reliability.

ESD CAUTION

ESD (electrostatic discharge) sensitive device. Electrostatic charges as high as 4000 V readily accumulate on the human body and test equipment and can discharge without detection. Although this product features proprietary ESD protection circuitry, permanent damage may occur on devices subjected to high energy electrostatic discharges. Therefore, proper ESD precautions are recommended to avoid performance degradation or loss of functionality.



PIN CONFIGURATION AND FUNCTION DESCRIPTIONS

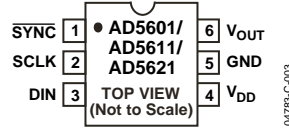

Figure 3. 6-Lead SC70 Pin Configuration

Table 5. Pin Function Descriptions

Pin No.	Mnemonic	Function
1	$\overline{\text{SYNC}}$	Level-Triggered Control Input (Active Low). This is the frame synchronization signal for the input data. When $\overline{\text{SYNC}}$ goes low, it enables the input shift register, and data is transferred in on the falling edges of the clocks that follow. The DAC is updated following the 16 th clock cycle unless $\overline{\text{SYNC}}$ is taken high before this edge, in which case the rising edge of $\overline{\text{SYNC}}$ acts as an interrupt and the write sequence is ignored by the DAC.
2	SCLK	Serial Clock Input. Data is clocked into the input shift register on the falling edge of the serial clock input. Data can be transferred at rates up to 30 MHz.
3	DIN	Serial Data Input. This device has a 16-bit shift register. Data is clocked into the register on the falling edge of the serial clock input.
4	V _{DD}	Power Supply Input. The AD5601/AD5611/AD5621 can be operated from 2.7 V to 5.5 V. V _{DD} should be decoupled to GND.
5	GND	Ground Reference Point for All Circuitry on the AD5601/AD5611/AD5621.
6	V _{OUT}	Analog Output Voltage from the DAC. The output amplifier has rail-to-rail operation.

TERMINOLOGY

Relative Accuracy

For the DAC, relative accuracy or integral nonlinearity (INL) is a measure of the maximum deviation, in LSBs, from a straight line passing through the endpoints of the DAC transfer function. A typical INL versus code plot can be seen in Figure 4.

Differential Nonlinearity

Differential nonlinearity (DNL) is the difference between the measured change and the ideal 1 LSB change between any two adjacent codes. A specified differential nonlinearity of ± 1 LSB maximum ensures monotonicity. This DAC is guaranteed monotonic by design. A typical DNL versus code plot can be seen in Figure 7.

Zero-Code Error

Zero-code error is a measure of the output error when zero code (0x0000) is loaded to the DAC register. Ideally, the output should be 0 V. The zero-code error is always positive in the AD5601/AD5611/AD5621, because the output of the DAC cannot go below 0 V. Zero-code error is due to a combination of the offset errors in the DAC and output amplifier. Zero-code error is expressed in mV. A plot of zero-code error versus temperature can be seen in Figure 6.

Full-Scale Error

Full-scale error is a measure of the output error when full-scale code (0xFFFF) is loaded to the DAC register. Ideally, the output should be $V_{DD} - 1$ LSB. Full-scale error is expressed in percent of full-scale range. A plot of full-scale error versus temperature can be seen in Figure 6.

Gain Error

Gain error is a measure of the span error of the DAC. It is the deviation in slope of the DAC transfer characteristic from ideal, expressed as a percent of the full-scale range.

Total Unadjusted Error

Total unadjusted error (TUE) is a measure of the output error taking all the various errors into account. A typical TUE versus code plot can be seen in Figure 5.

Zero-Code Error Drift

Zero-code error drift is a measure of the change in zero-code error with a change in temperature. It is expressed in $\mu\text{V}/^\circ\text{C}$.

Gain Error Drift

Gain error drift is a measure of the change in gain error with changes in temperature. It is expressed in (ppm of full-scale range)/ $^\circ\text{C}$.

Digital-to-Analog Glitch Impulse

Digital-to-analog glitch impulse is the impulse injected into the analog output when the input code in the DAC register changes state. It is normally specified as the area of the glitch in nV-s and is measured when the digital input code is changed by 1 LSB at the major carry transition (0x7FFF to 0x8000). See Figure 17.

Digital Feedthrough

Digital feedthrough is a measure of the impulse injected into the analog output of the DAC from the digital inputs of the DAC, but is measured when the DAC output is not updated. It is specified in nV-s and is measured with a full-scale code change on the data bus, that is, from all 0s to all 1s and vice versa.

TYPICAL PERFORMANCE CHARACTERISTICS

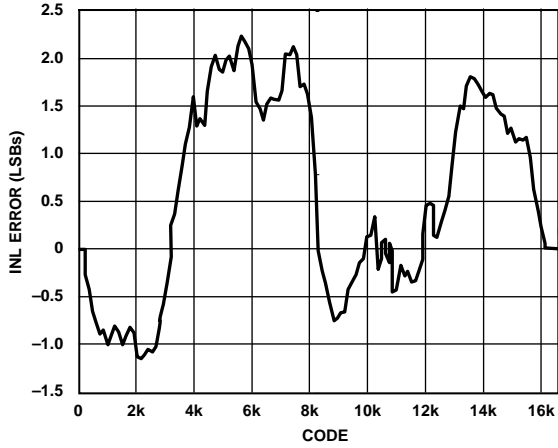

Figure 4. Typical INL Plot

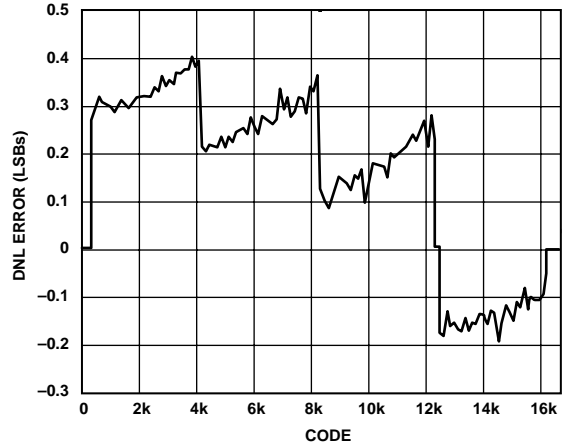

Figure 7. Typical DNL Plot

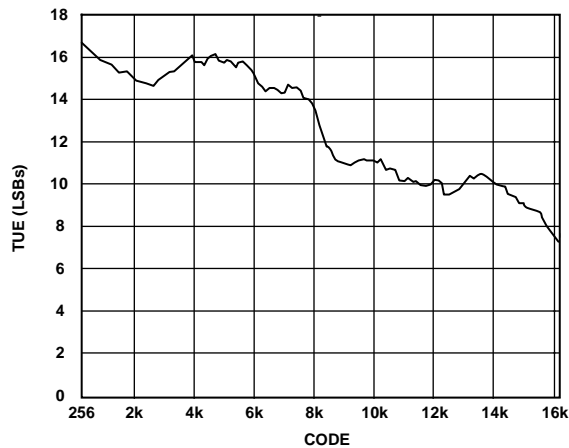

Figure 5. Total Unadjusted Error

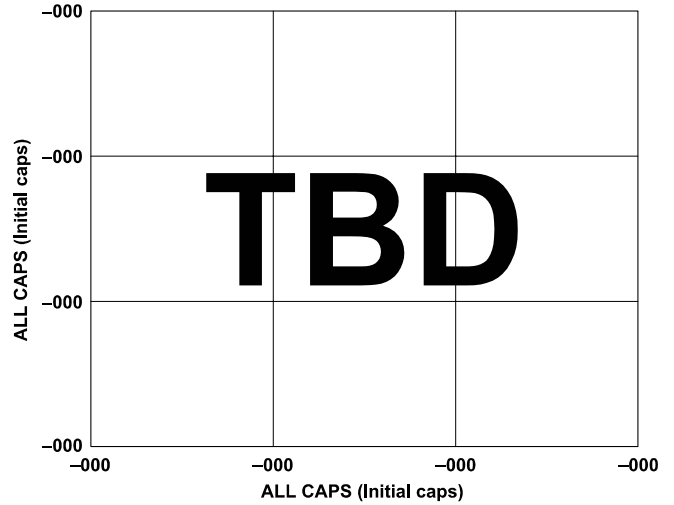

Figure 8. INL and DNL vs. Supply

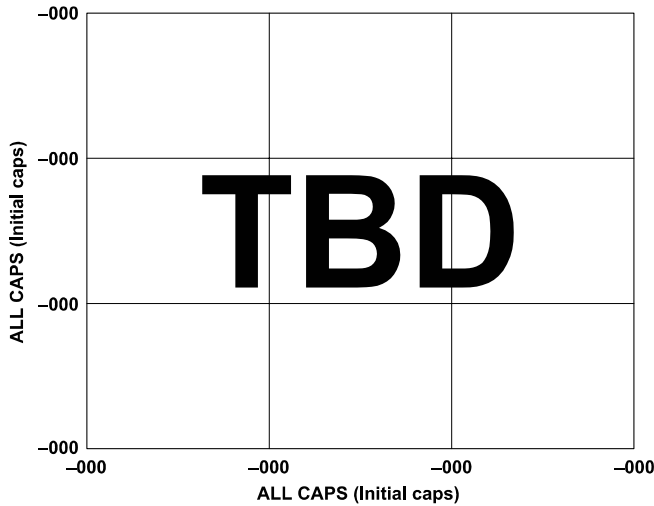

Figure 6. Zero-Scale Error and Full-Scale Error vs. Temperature

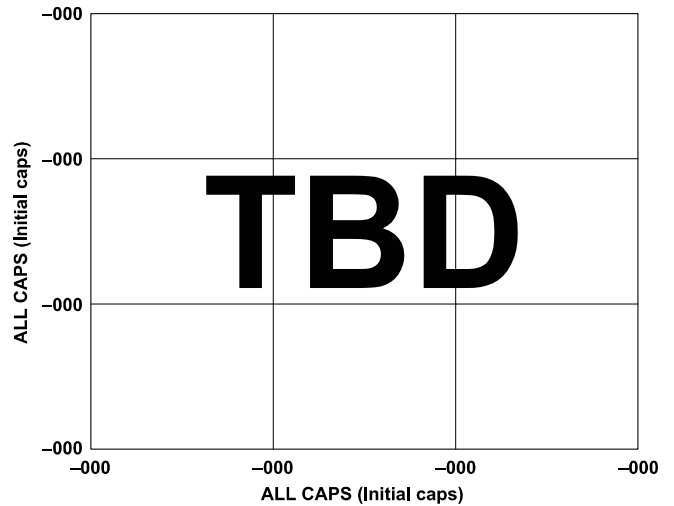

Figure 9. I_{DD} Histogram @ $V_{DD} = 3 V/5 V$

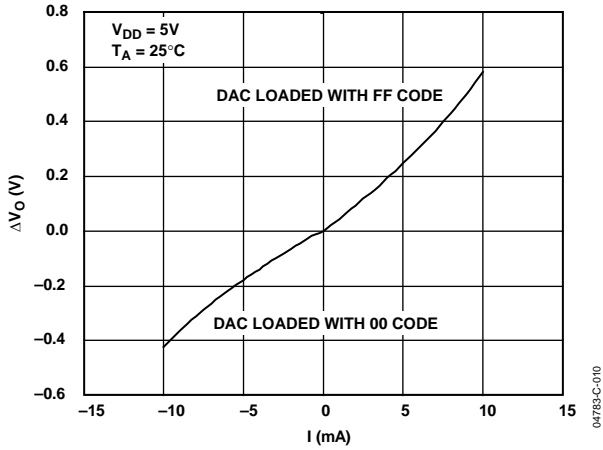

Figure 10. Source and Sink Current Capability

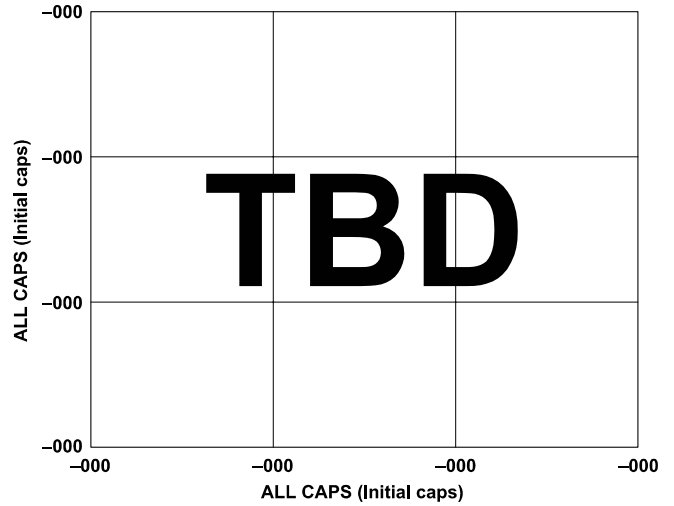

Figure 13. Supply Current vs. Code

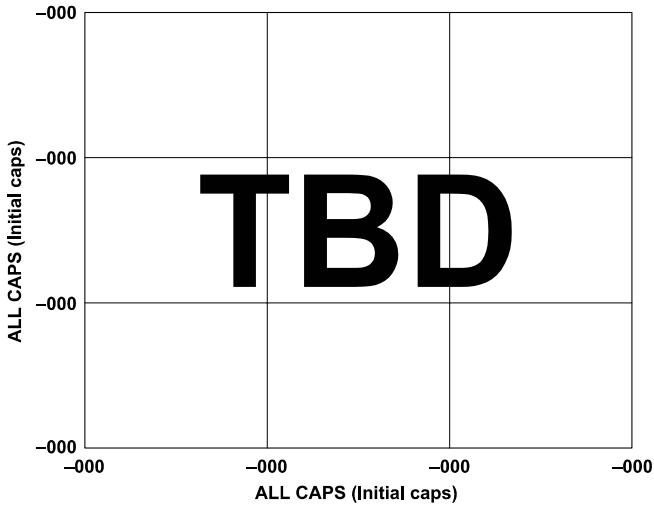

Figure 11. Supply Current vs. Temperature

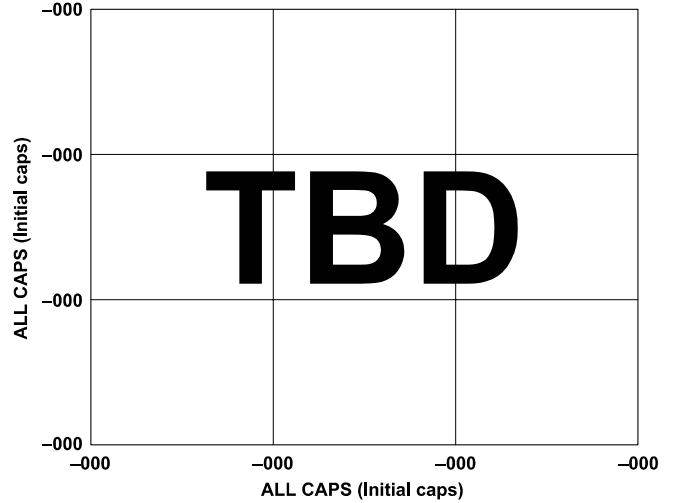

Figure 14. Supply Current vs. Supply Voltage

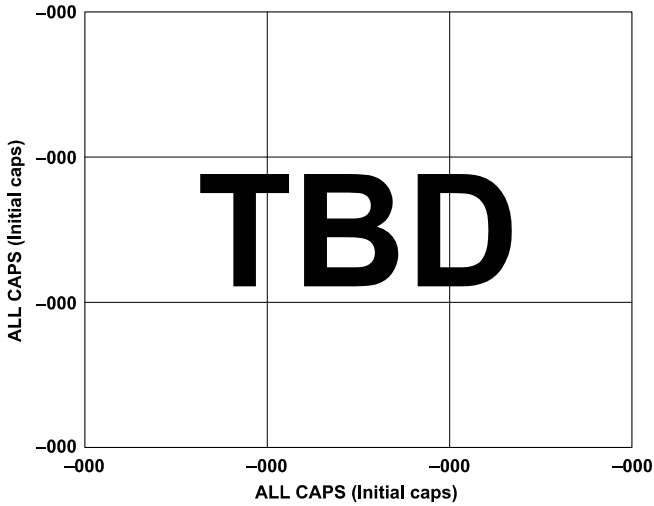

Figure 12. Full-Scale Settling Time

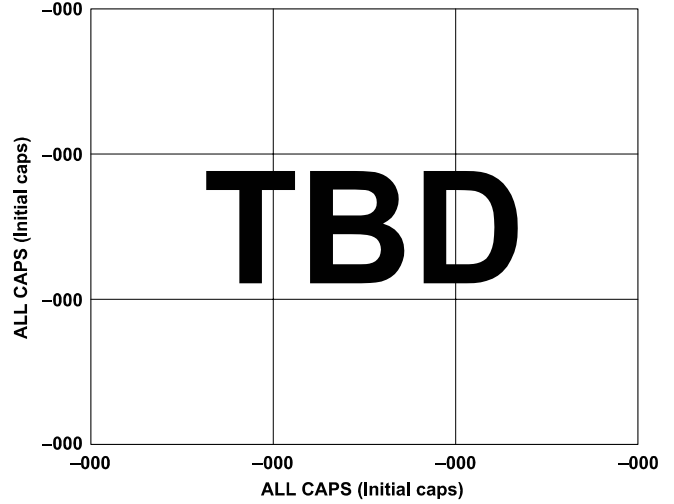

Figure 15. Half-Scale Settling Time

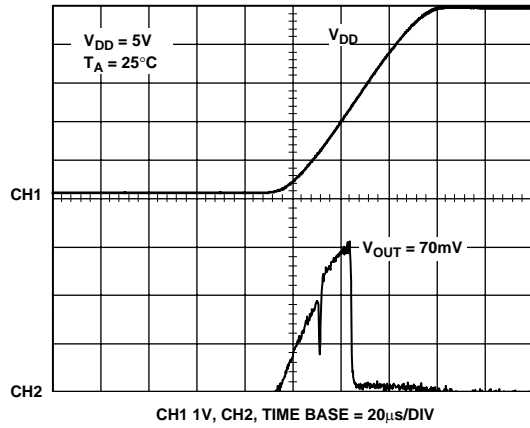

Figure 16. Power-On Reset to 0V

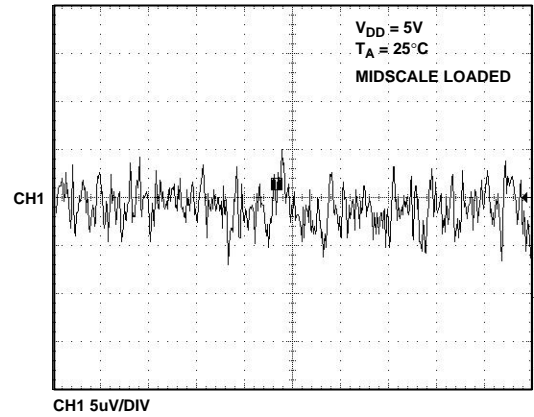

Figure 19. 1/f Noise, 0.1 Hz to 10 Hz Bandwidth

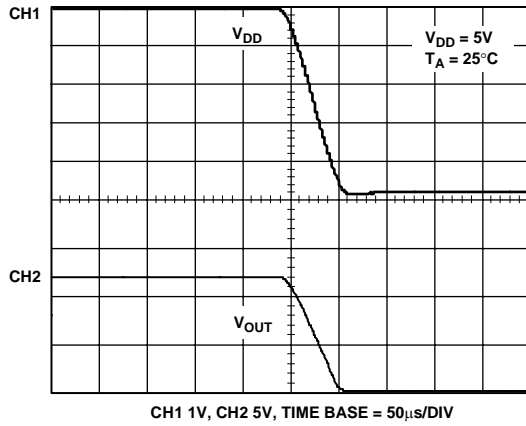

Figure 17. V_{DD} vs. V_{OUT} (Power-Down)

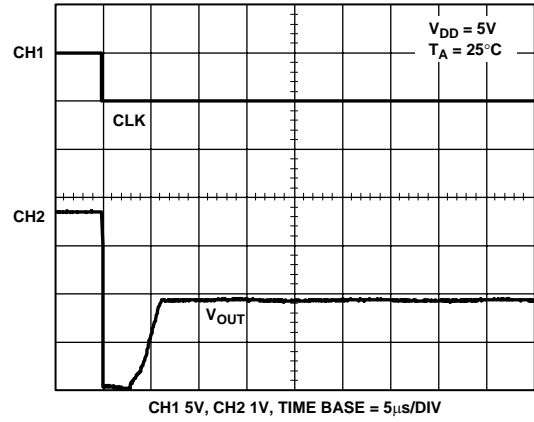

Figure 20. Exiting Power-Down

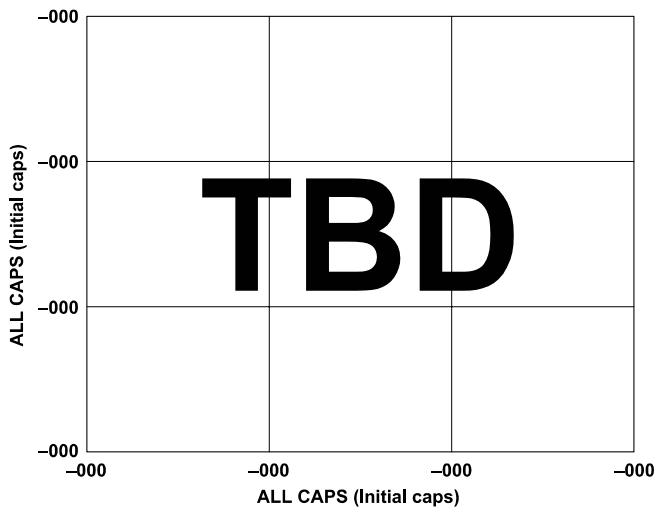

Figure 18. Digital-to-Analog Glitch Impulse

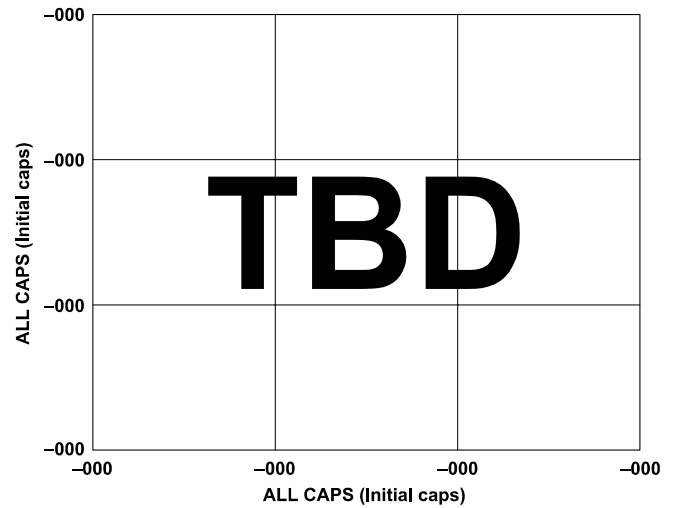

Figure 21. Harmonic Distortion on Digitally Generated Waveform

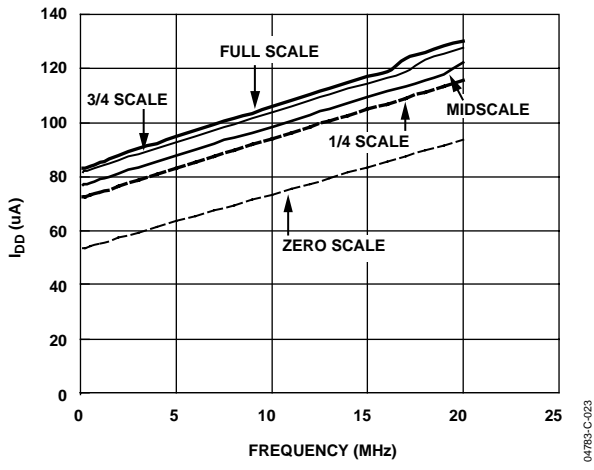

Figure 22. IDD vs. SCLK vs. Code

04783-C-023

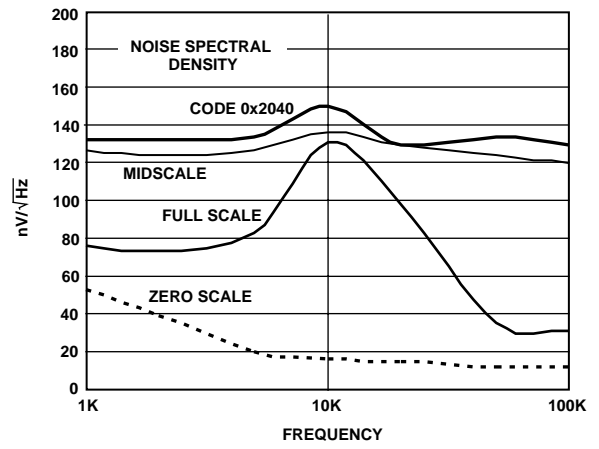

Figure 23. Noise Spectral Density

04783-C-024

GENERAL DESCRIPTION

D/A SECTION

The AD5601/AD5611/AD5621 DAC are fabricated on a CMOS process. The architecture consists of a string DAC followed by an output buffer amplifier. Figure 24 is a block diagram of the DAC architecture.

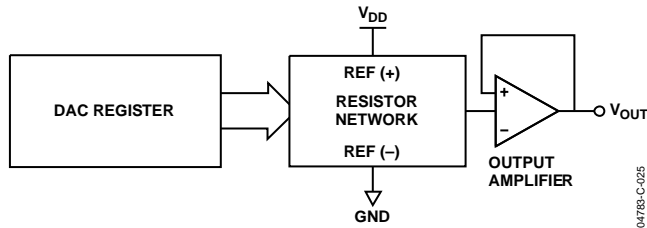

Figure 24. DAC Architecture

Because the input coding to the DAC is straight binary, the ideal output voltage is given by

$$V_{OUT} = V_{DD} \times \left(\frac{D}{2^N} \right)$$

where D is the decimal equivalent of the binary code that is loaded to the DAC register.

RESISTOR STRING

The resistor string section is shown in Figure 25. It is simply a string of resistors, each of value R . The code loaded to the DAC register determines at which node on the string the voltage is tapped off to be fed into the output amplifier. The voltage is tapped off by closing one of the switches connecting the string to the amplifier. Because it is a string of resistors, it is guaranteed monotonic.

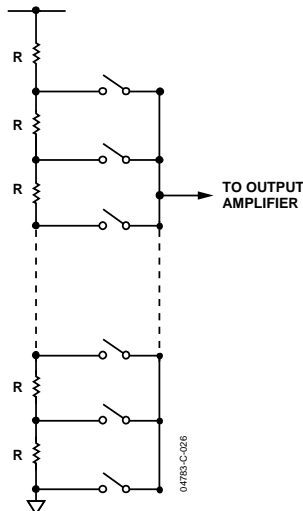

Figure 25. Resistor String Section

OUTPUT AMPLIFIER

The output buffer amplifier is capable of generating rail-to-rail voltages on its output, giving an output range of 0 V to V_{DD} . It is capable of driving a load of 2 k Ω in parallel with 1000 pF to GND. The source and sink capabilities of the output amplifier can be seen in Figure 10. The slew rate is 0.5 V/ μ s, with a half-scale settling time of 8 μ s with the output unloaded.

SERIAL INTERFACE

The AD5601/AD5611/AD5621 have a 3-wire serial interface ($\overline{\text{SYNC}}$, SCLK, and DIN) that is compatible with SPI, QSPI, and MICROWIRE interface standards as well as most DSPs. See Figure 2 for a timing diagram of a typical write sequence.

The write sequence begins by bringing the $\overline{\text{SYNC}}$ line low. Data from the DIN line is clocked into the 16-bit shift register on the falling edge of SCLK. The serial clock frequency can be as high as 30 MHz, making the AD5601/AD5611/AD5621 compatible with high speed DSPs. On the 16th falling clock edge, the last data bit is clocked in and the programmed function is executed (a change in DAC register contents and/or a change in the mode of operation). At this stage, the $\overline{\text{SYNC}}$ line might be kept low or brought high. In either case, it must be brought high for a minimum of 33 ns before the next write sequence so that a falling edge of $\overline{\text{SYNC}}$ can initiate the next write sequence.

Because the $\overline{\text{SYNC}}$ buffer draws more current when $V_{IN} = 1.8$ V than it does when $V_{IN} = 0.8$ V, $\overline{\text{SYNC}}$ should be idled low between write sequences for even lower power operation of the part, as mentioned above. However, it must be brought high again just before the next write sequence.

INPUT SHIFT REGISTER

The input shift register is 16 bits wide (see Figure 26). The first two bits are control bits that control which mode of operation the power is in (normal mode or any one of three power-down modes). For a complete description of the various modes, see the Power-Down Modes section. The next 16 bits are the data bits, which are transferred to the DAC register on the 16th falling edge of SCLK.

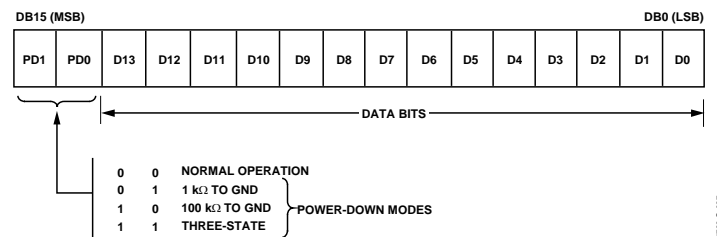

Figure 26. Input Register Contents

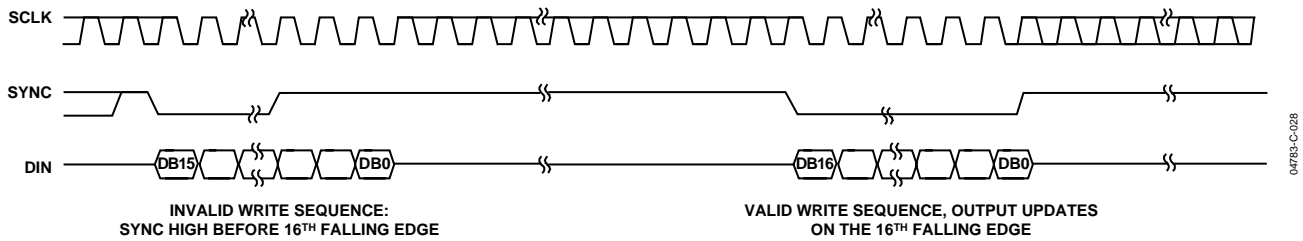

Figure 27. $\overline{\text{SYNC}}$ Interrupt Facility

SYNC INTERRUPT

In a normal write sequence, the $\overline{\text{SYNC}}$ line is kept low for at least 16 falling edges of SCLK and the DAC is updated on the 16th falling edge. However, if $\overline{\text{SYNC}}$ is brought high before the 16th falling edge, this acts as an interrupt to the write sequence. The shift register is reset and the write sequence is seen as invalid. Neither an update of the DAC register contents nor a change in the operating mode occurs (see Figure 27).

POWER-ON RESET

The AD5601/AD5611/AD5621 contain a power-on reset circuit that controls the output voltage during power-up. The DAC register is filled with zeros and the output voltage is 0 V. It remains there until a valid write sequence is made to the DAC. This is useful in applications in which it is important to know the state of the DAC's output while it is in the process of powering up.

POWER-DOWN MODES

The AD5601/AD5611/AD5621 have four separate modes of operation. These modes are software-programmable by setting two bits (DB15 and DB14) in the control register. Table 6 shows how the state of the bits corresponds to the mode of operation of the device.

Table 6. Modes of Operation for the AD5601/AD5611/AD5621

DB15	DB14	Operating Mode
0	0	Normal operation Power-down mode
0	1	1 kΩ to GND
1	0	100 kΩ to GND
1	1	Three-state

When both bits are set to 0, the part works normally with its normal power consumption of 100 μA maximum at 5 V. However, for the three power-down modes, the supply current falls to <100 nA at 3 V. Not only does the supply current fall, but the output stage is also internally switched from the output of the amplifier to a resistor network of known values. This has the advantage that the output impedance of the part is known while

the part is in power-down mode. There are three different options: the output is connected internally to GND through a 1 kΩ resistor or a 100 kΩ resistor, or the output is left open-circuited (three-state). Figure 28 shows the output stage.

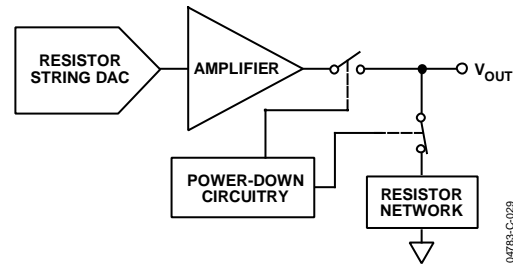

Figure 28. Output Stage During Power-Down

The bias generator, output amplifier, resistor string, and other associated linear circuitry are all shut down when the power-down mode is activated. However, the contents of the DAC register are unaffected when in power-down. The time to exit power-down is typically 2.5 μs for V_{DD} = 5 V and 5 μs for V_{DD} = 3 V. See Figure 20 for a plot.

MICROPROCESSOR INTERFACING

AD5601/AD5611/AD5621 to ADSP-2101/ADSP-2103 Interface

Figure 29 shows a serial interface between the AD5601/AD5611/AD5621 and the ADSP-2101/ADSP-2103. The ADSP-2101/ADSP-2103 should be set up to operate in SPORT transmit alternate framing mode. The ADSP-2101/ADSP-2103 SPORT are programmed through the SPORT control register and should be configured as follows: internal clock operation, active low framing, and 16-bit word length. Transmission is initiated by writing a word to the Tx register after the SPORT has been enabled.

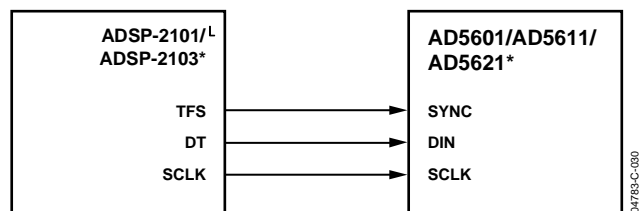

*ADDITIONAL PINS OMITTED FOR CLAIRTY

Figure 29. AD5601/AD5611/AD5621 to ADSP-2101/ADSP-2103 Interface

AD5601/AD5611/AD5621 to 68HC11/68L11 Interface

Figure 30 shows a serial interface between the AD5601/AD5611/AD5621 and the 68HC11/68L11 microcontrollers. SCK of the 68HC11/68L11 drives the SCLK of the AD5601/AD5611/AD5621, while the MOSI output drives the serial data line of the DAC. The SYNC signal is derived from a port line (PC7). The setup conditions for correct operation of this interface are as follows: the 68HC11/68L11 should be configured so that its CPOL bit is a 0 and its CPHA bit is a 1. When data is being transmitted to the DAC, the SYNC line is taken low (PC7). When the 68HC11/68L11 is configured as above, data appearing on the MOSI output is valid on the falling edge of SCK. Serial data from the 68HC11/68L11 is transmitted in 8-bit bytes with only eight falling clock edges occurring in the transmit cycle. Data is transmitted MSB first. To load data to the AD5601/AD5611/AD5621, PC7 is left low after the first eight bits are transferred, and a second serial write operation is performed to the DAC. PC7 is taken high at the end of this procedure.

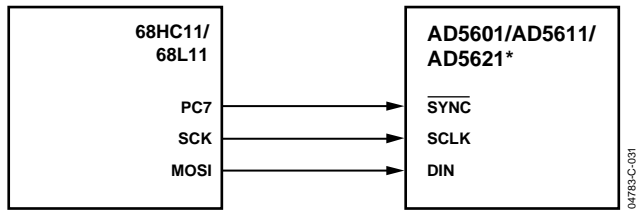

*ADDITIONAL PINS OMITTED FOR CLAIRTY

Figure 30. AD5601/AD5611/AD5621 to 68HC11/68L11 Interface

AD5601/AD5611/AD5621 to Blackfin® ADSP-BF53X Interface

Figure 31 shows a serial interface between the AD5601/AD5611/AD5621 and the Blackfin ADSP-BF53x microprocessors. The ADSP-BF53x processor family incorporates two dual-channel synchronous serial ports, SPORT1 and SPORT0, for serial and multiprocessor communications. Using SPORT0 to connect to the AD5601/AD5611/AD5621, the setup for the interface is as follows: DT0PRI drives the SDIN pin of the AD5601/AD5611/AD5621, while TSCLK0 drives the SCLK of the part. The SYNC is driven from TFS0.

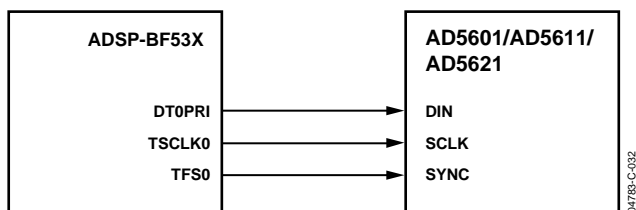

*ADDITIONAL PINS OMITTED FOR CLAIRTY

Figure 31. AD5601/AD5611/AD5621 to Blackfin ADSP-BF53X Interface

AD5601/AD5611/AD5621 to 80C51/80L51 Interface

Figure 32 shows a serial interface between the AD5601/AD5611/AD5621 and the 80C51/80L51 microcontroller. The setup for the interface is as follows: TXD of the 80C51/80L51 drives SCLK of the AD5601/AD5611/AD5621, while RXD drives the serial data line of the part. The SYNC signal is again derived from a bit programmable pin on the port. In this case, port line P3.3 is used. When data is to be transmitted to the AD5601/AD5611/AD5621, P3.3 is taken low. The 80C51/80L51 transmit data only in 8-bit bytes; thus, only eight falling clock edges occur in the transmit cycle. To load data to the DAC, P3.3 is left low after the first eight bits are transmitted, and a second write cycle is initiated to transmit the second byte of data. P3.3 is taken high following the completion of this cycle. The 80C51/80L51 output the serial data in a format that has the LSB first. The AD5601/AD5611/AD5621 require their data with the MSB as the first bit received. The 80C51/80L51 transmit routine should take this into account.

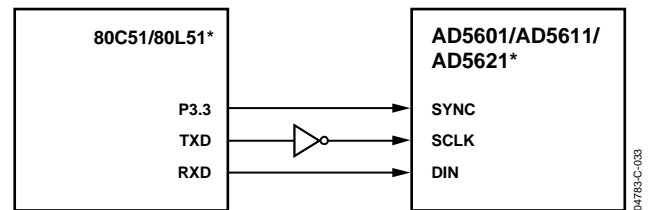

*ADDITIONAL PINS OMITTED FOR CLAIRTY

Figure 32. AD5601/AD5611/AD5621 to 80C51/80L51 Interface

AD5601/AD5611/AD5621 to MICROWIRE Interface

Figure 33 shows an interface between the AD5601/AD5611/AD5621 and any MICROWIRE compatible device. Serial data is shifted out on the falling edge of the serial clock and is clocked into the AD5601/AD5611/AD5621 on the rising edge of the SK.

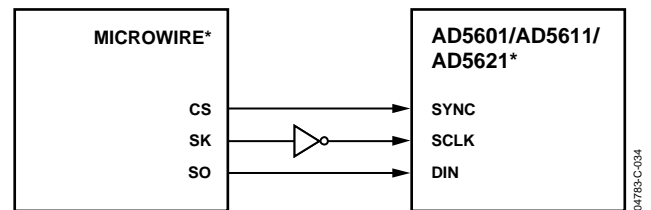

*ADDITIONAL PINS OMITTED FOR CLAIRTY

Figure 33. AD5601/AD5611/AD5621 to MICROWIRE Interface

APPLICATIONS

CHOOSING A REFERENCE AS POWER SUPPLY FOR AD5601/AD5611/AD5621

The AD5601/AD5611/AD5621 come in a tiny SC70 package with less than 100 μA supply current. Because of this, the choice of reference depends on the application requirement. For space-saving applications, the ADR425 is available in an SC70 package and has excellent drift at 3 ppm/ $^{\circ}\text{C}$. It also provides very good noise performance at 3.4 μV p-p in the 0.1 Hz to 10 Hz range.

Because the supply current required by the AD5601/AD5611/AD5621 is extremely low, the parts are ideal for low supply applications. The ADR293 voltage reference is recommended in this case. This requires 15 μA of quiescent current and can, therefore, drive multiple DACs in one system, if required.

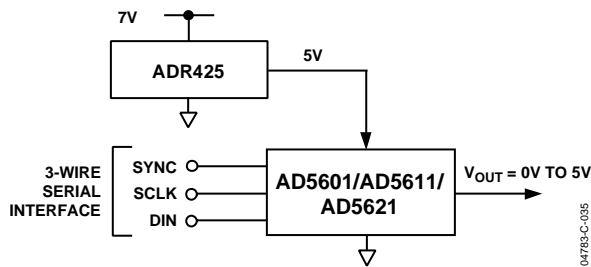

Figure 34. ADR425 as Power Supply to the AD5601/AD5611/AD5621

Some recommended precision references for use as supplies to the AD5601/AD5611/AD5621 are listed in Table 7.

Table 7. Precision References for Use with AD5601/AD5611/AD5621

Part No.	Initial Accuracy (mV max)	Temperature Drift (ppm/ $^{\circ}\text{C}$ max)	0.1 Hz to 10 Hz Noise (μV p-p typ)
ADR435	± 6	3	3.4
ADR425	± 6	3	3.4
ADR02	± 5	3	15
ADR395	± 6	25	5

BIPOLAR OPERATION USING THE AD5601/AD5611/AD5621

The AD5601/AD5611/AD5621 have been designed for single-supply operation, but a bipolar output range is also possible using the circuit in Figure 35. The circuit in Figure 35 gives an output voltage range of ± 5 V. Rail-to-rail operation at the amplifier output is achievable using an AD820 or OP295 as the output amplifier.

The output voltage for any input code can be calculated as follows:

$$V_O = \left[V_{DD} \times \left(\frac{D}{2^N} \right) \times \left(\frac{R1 + R2}{R1} \right) - V_{DD} \times \left(\frac{R2}{R1} \right) \right]$$

where D represents the input code in decimal ($0-2^N$).

With $V_{DD} = 5$ V, $R1 = R2 = 10$ k Ω :

$$V_O = \left(\frac{10 \times D}{2^N} \right) - 5\text{V}$$

This is an output voltage range of ± 5 V with 0x0000 corresponding to a -5 V output, and 0x3FFF corresponding to a $+5$ V output.

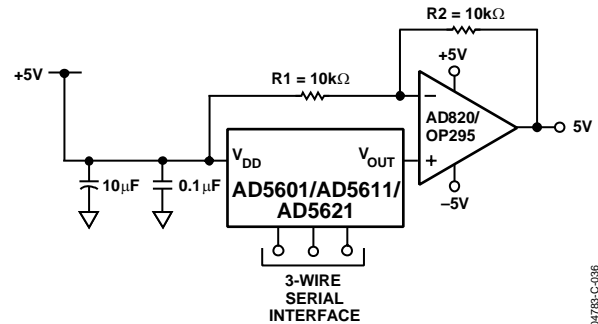

Figure 35. Bipolar Operation with the AD5601/AD5611/AD5621

USING AD5601/AD5611/AD5621 WITH AN OPTO-ISOLATED INTERFACE

In process-control applications in industrial environments, it is often necessary to use an opto-isolated interface to protect and isolate the controlling circuitry from any hazardous common-mode voltages that might occur in the area where the DAC is functioning. Opto-isolators provide isolation in excess of 3 kV. Because the AD5601/AD5611/AD5621 use a 3-wire serial logic interface, they require only three opto-isolators to provide the required isolation (see Figure 36). The power supply to the parts also needs to be isolated. This is done by using a transformer. On the DAC side of the transformer, a 5 V regulator provides the 5 V supply required for the AD5601/AD5611/AD5621.

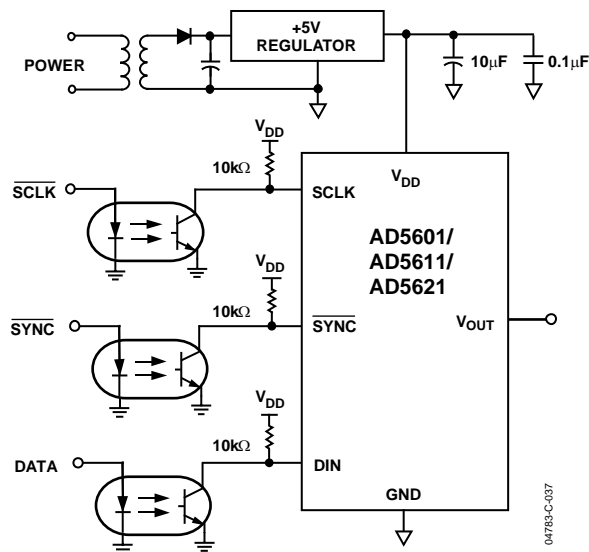

Figure 36. AD5601/AD5611/AD5621 with an Opto-Isolated Interface

POWER SUPPLY BYPASSING AND GROUNDING

When accuracy is important in a circuit, it is helpful to carefully consider the power supply and ground return layout on the board. The printed circuit board containing the AD5601/AD5611/AD5621 should have separate analog and digital sections, each having its own area of the board. If the AD5601/AD5611/AD5621 are in a system where other devices require an AGND to DGND connection, the connection should be made at one point only. This ground point should be as close to the AD5601/AD5611/AD5621 as possible.

The power supply to the AD5601/AD5611/AD5621 should be bypassed with 10 μF and 0.1 μF capacitors. The capacitors should be physically as close as possible to the device, with the 0.1 μF capacitor ideally right up against the device. The 10 μF capacitors are the tantalum bead type. It is important that the 0.1 μF capacitor have low effective series resistance (ESR) and effective series inductance (ESI), such as in common ceramic types of capacitors. This 0.1 μF capacitor provides a low impedance path to ground for high frequencies caused by transient currents due to internal logic switching.

The power supply line itself should have as large a trace as possible to provide a low impedance path and reduce glitch effects on the supply line. Clocks and other fast switching digital signals should be shielded from other parts of the board by digital ground. Avoid crossover of digital and analog signals, if possible. When traces cross on opposite sides of the board, ensure that they run at right angles to each other to reduce feedthrough effects through the board. The best board layout technique is the microstrip technique where the component side of the board is dedicated to the ground plane only and the signal traces are placed on the solder side. However, this is not always possible with a 2-layer board.

OUTLINE DIMENSIONS

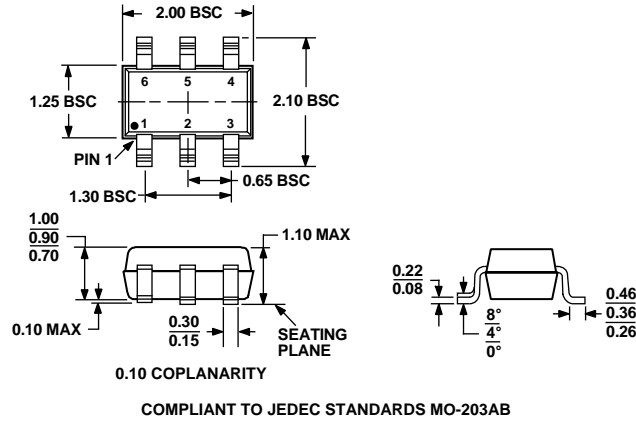

Figure 37. 6-Lead Plastic Surface Mount Package [SC70]
 (KS-6)
 Dimensions shown in millimeters

ORDERING GUIDE

Model	Temperature Range	Description	Package Description	Package Option
AD5601BKS	-40°C to +125°C	±0.5 LSB INL	6-Lead Plastic Surface Mount Package (SC70)	KS-6
AD5611BKS	-40°C to +125°C	±0.5 LSB INL	6-Lead Plastic Surface Mount Package (SC70)	KS-6
AD5611AKS	-40°C to +125°C	±4.0 LSB INL	6-Lead Plastic Surface Mount Package (SC70)	KS-6
AD5621BKS	-40°C to +125°C	±1.0 LSB INL	6-Lead Plastic Surface Mount Package (SC70)	KS-6
AD5621AKS	-40°C to +125°C	±6.0 LSB INL	6-Lead Plastic Surface Mount Package (SC70)	KS-6

NOTES

NOTES