

9097250 TOSHIBA (DISCRETE/OPTO)

56C 07793 D T-33-29

2SD799SILICON NPN TRIPLE DIFFUSED TYPE
(DARLINGTON POWER)

IGNITER APPLICATIONS.

HIGH VOLTAGE SWITCHING APPLICATIONS.

FEATURES:

- High DC Current Gain : $h_{FE}=600(\text{Min.}) (V_{CE}=2V, I_C=2A)$
- Monolithic Construction with Built-In Base-
Emitter Shunt Resistor.

MAXIMUM RATINGS ($T_a=25^\circ\text{C}$)

CHARACTERISTIC	SYMBOL	RATING	UNIT
Collector-Base Voltage	V_{CBO}	600	V
Collector-Emitter Voltage	V_{CEO}	400	V
Emitter-Base Voltage	V_{EBO}	5	V
Collector Current	I_C	6.	A
Base Current	I_B	1	A
Collector Power Dissipation ($T_c=25^\circ\text{C}$)	P_C	30	W
Junction Temperature	T_j	150	$^\circ\text{C}$
Storage Temperature Range	T_{stg}	-55~150	$^\circ\text{C}$

EQUIVALENT CIRCUIT

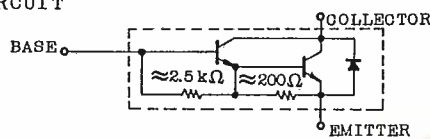

INDUSTRIAL APPLICATIONS

Unit in mm

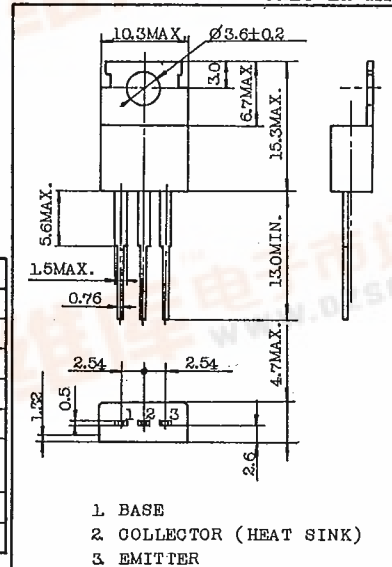

JEDEC TO - 220 AB

EIAJ SC - 46

TOSHIBA 2 - 10 A 1 A

Mounting Kit No. AC75

Weight : 1.9g

ELECTRICAL CHARACTERISTICS ($T_a=25^\circ\text{C}$)

CHARACTERISTIC		SYMBOL	TEST CONDITION	MIN.	TYP.	MAX.	UNIT
Collector Cut-off Current		I_{CBO}	$V_{CB}=600V, I_E=0$	-	-	0.5	mA
Emitter Cut-off Current		I_{EBO}	$V_{EB}=5V, I_C=0$	-	-	3	mA
Collector-Emitter Breakdown Voltage		$V_{(BR)CEO}$	$I_C=10mA, I_B=0$	400	-	-	V
DC Current Gain		$h_{FE}(1)$	$V_{CE}=2V, I_C=2A$	600	-	-	
		$h_{FE}(2)$	$V_{CE}=2V, I_C=4A$	100	-	-	
Collector-Emitter Saturation Voltage		$V_{CE(sat)}$	$I_C=4A, I_B=0.04A$	-	-	2.0	V
Base-Emitter Saturation Voltage		$V_{BE(sat)}$	$I_C=4A, I_B=0.04A$	-	-	2.5	V
Emitter-Collector Forward Voltage		V_{ECF}	$I_E=4A, I_B=0$	-	-	3.0	V
Collector Output Capacitance		C_{ob}	$V_{CB}=50V, I_E=0, f=1MHz$	-	35	-	pF
Switching Time	Turn-on Time	t_{on}		-	1	-	µs
	Storage Time	t_{stg}		-	8	-	
	Fall Time	t_f		-	5	-	

TOSHIBA CORPORATION

2SD799

STATIC CHARACTERISTICS

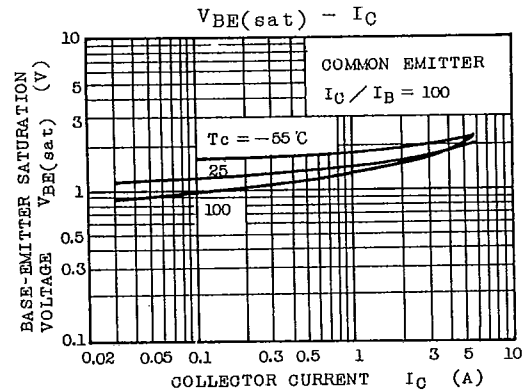
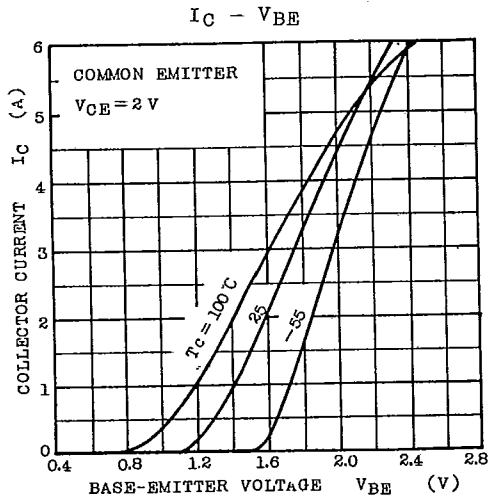
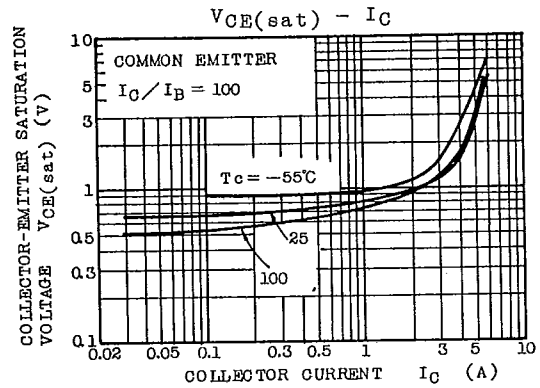
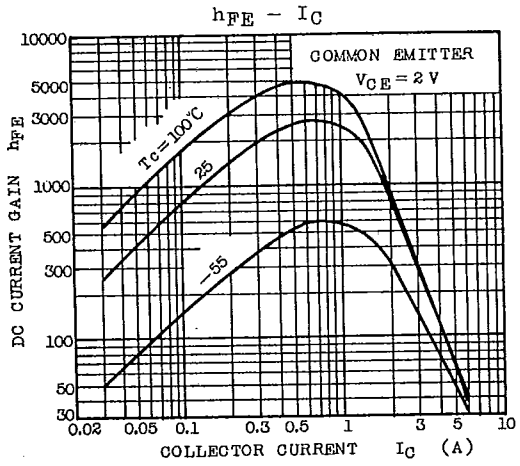
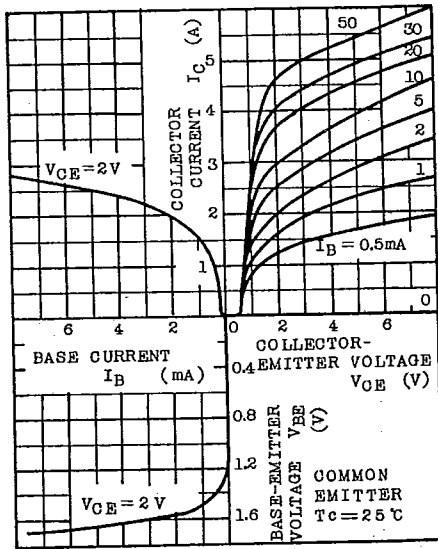

2SD799

