

UTC D965SS / D965ASS NPN EPITAXIAL SILICON TRANSISTOR

LOW VOLTAGE HIGH CURRENT
NPN TRANSISTOR

FEATURES

- * Collector current up to 5A
- * D965SS : Collector-Emitter voltage up to 20 V
- * D965ASS : Collector-Emitter voltage up to 30 V

APPLICATIONS

- * Audio amplifier
- * Flash unit of camera
- * Switching circuit

MARKING(D965SS) MARKING(D965ASS)

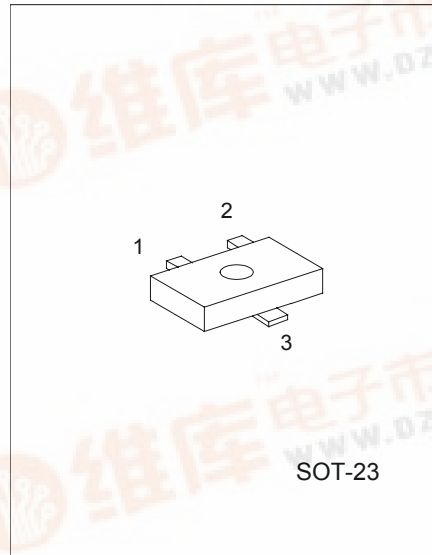
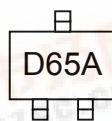
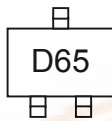

1: EMITTER 2: BASE 3: COLLECTOR

ABSOLUTE MAXIMUM RATINGS (Ta=25°C , unless otherwise specified)

PARAMETER	SYMBOL	RATING	UNIT
Collector-base voltage	V _{CB0}	40	V
Collector-emitter voltage	V _{CEO}	20	V
D965SS		30	
D965ASS			
Emitter-base voltage	V _{EB0}	7	V
Collector dissipation(Ta=25°C)	P _c	750	mW
Collector current	I _c	5	A
Junction Temperature	T _j	150	°C
Storage Temperature	T _{STG}	-65 ~ +150	°C

ELECTRICAL CHARACTERISTICS(Ta=25°C, unless otherwise specified)

PARAMETER	SYMBOL	TEST CONDITIONS	MIN	TYP	MAX	UNIT
Collector-base breakdown voltage	BV _{CB0}	I _c =100μA, I _E =0	40			V
Collector-emitter breakdown voltage	BV _{CEO}	I _c =1mA, I _B =0	20			V
D965SS			30			
D965ASS						
Emitter-base breakdown voltage	BV _{EB0}	I _E =10μA, I _c =0	7			V
Collector cut-off current	I _{CB0}	V _{CB} =10V, I _E =0			100	nA
Emitter cut-off current	I _{EB0}	V _{EB} =7V, I _c =0			100	nA

UTC UNISONIC TECHNOLOGIES CO. LTD

1

QW-R206-016,B

UTC D965SS / D965ASS

NPN EPITAXIAL SILICON TRANSISTOR

DC current gain(note)	hFE	VCE=2V, Ic=1mA VCE=2V, Ic=0.5A VCE=2V, Ic=2A	230 150	200	800	
PARAMETER	SYMBOL	TEST CONDITIONS	MIN	TYP	MAX	UNIT
Collector-emitter saturation voltage	VCE(sat)	Ic=3A, Ib= 0.1A			1	V
Current gain bandwidth product	fT	VCE=6V, Ic=50mA		150		MHz
Output capacitance	Cob	VCB=20V, IE=0 f=1MHz			50	pF

CLASSIFICATION OF hFE2

RANK	Q	R	S
RANGE	230-380	340-600	560-800

TYPICAL CHARACTERISTIC CURVES

Fig.1 Static characteristics

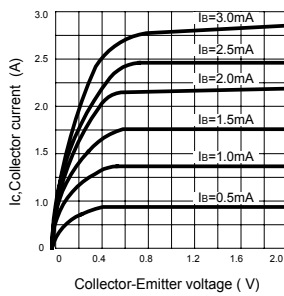

Fig.2 DC current Gain

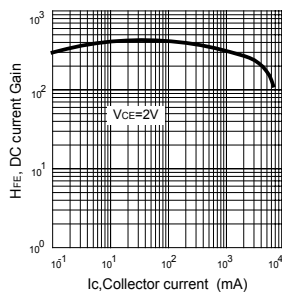

Fig.3 Base-Emitter on Voltage

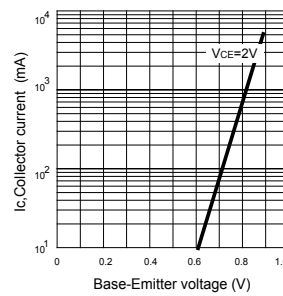

Fig.4 Saturation voltage

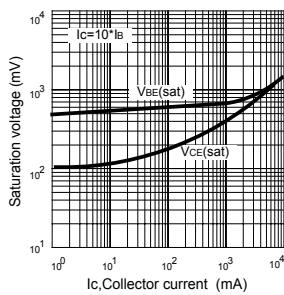

Fig.5 Current gain-bandwidth product

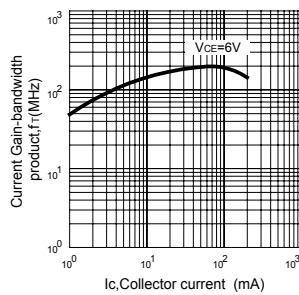
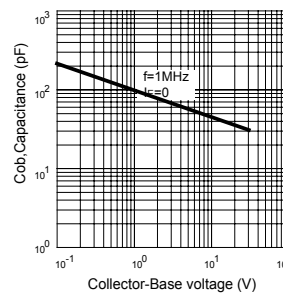

Fig.6 Collector output Capacitance



UTC D965SS / D965ASS

NPN EPITAXIAL SILICON TRANSISTOR

UTC assumes no responsibility for equipment failures that result from using products at values that exceed, even momentarily, rated values (such as maximum ratings, operating condition ranges, or other parameters) listed in products specifications of any and all UTC products described or contained herein. UTC products are not designed for use in life support appliances, devices or systems where malfunction of these products can be reasonably expected to result in personal injury. Reproduction in whole or in part is prohibited without the prior written consent of the copyright owner. The information presented in this document does not form part of any quotation or contract, is believed to be accurate and reliable and may be changed without notice.