



# Wireless Components

Mixer / Oscillator

TDA 6131 Version 1.0

Specification March 2000

preliminary

<b>Revision History: Current Version: 03.00</b>		
Previous Version:Data Sheet		
Page (in previous Version)	Page (in current Version)	Subjects (major changes since last revision)
Product Info	Product Info	Ordering code completed

ABM®, AOP®, ARCOFI®, ARCOFI®-BA, ARCOFI®-SP, DigiTape®, EPIC®-1, EPIC®-S, ELIC®, FALC®54, FALC®56, FALC®-E1, FALC®-LH, IDEC®, IOM®, IOM®-1, IOM®-2, IPAT®-2, ISAC®-P, ISAC®-S, ISAC®-S TE, ISAC®-P TE, ITAC®, IWE®, MUSAC®-A, OCTAT®-P, QUAT®-S, SICAT®, SICOFI®, SICOFI®-2, SICOFI®-4, SICOFI®-4µC, SLICOFI® are registered trademarks of Infineon Technologies AG.

ACE™, ASM™, ASP™, POTSWIRE™, QuadFALC™, SCOUT™ are trademarks of Infineon Technologies AG.

**Edition 03.99**

**Published by Infineon Technologies AG**

**SC,  
Balanstraße 73,  
81541 München**

© Infineon Technologies AG 16.03.00.  
All Rights Reserved.

**Attention please!**

As far as patents or other rights of third parties are concerned, liability is only assumed for components, not for applications, processes and circuits implemented within components or assemblies.

The information describes the type of component and shall not be considered as assured characteristics.

Terms of delivery and rights to change design reserved.

Due to technical requirements components may contain dangerous substances. For information on the types in question please contact your nearest Infineon Technologies Office.

Infineon Technologies AG is an approved CECC manufacturer.

**Packing**

Please use the recycling operators known to you. We can also help you – get in touch with your nearest sales office. By agreement we will take packing material back, if it is sorted. You must bear the costs of transport.

For packing material that is returned to us unsorted or which we are not obliged to accept, we shall have to invoice you for any costs incurred.

**Components used in life-support devices or systems must be expressly authorized for such purpose!**

Critical components<sup>1</sup> of the Infineon Technologies AG, may only be used in life-support devices or systems<sup>2</sup> with the express written approval of the Infineon Technologies AG.

- 1 A critical component is a component used in a life-support device or system whose failure can reasonably be expected to cause the failure of that life-support device or system, or to affect its safety or effectiveness of that device or system.
- 2 Life support devices or systems are intended (a) to be implanted in the human body, or (b) to support and/or maintain and sustain human life. If they fail, it is reasonable to assume that the health of the user may be endangered.

## Product Info

### General Description

- New B6HF bipolar technology, 25GHz ft
- Frequency range up to 3.0 GHz
- Small outline P-TSSOP 16 package
- 2.7-4.5V supply voltage
- -40°C to +85°C operational temperature range
- Standby function
- Reduced external components
- High isolation between mixer ports
- Good crosstalk performance

### Package

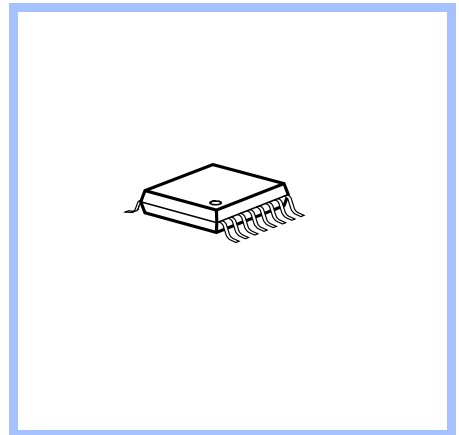

### Features

#### MIXER

- Universal Gilbert cell mixer with adjustable mixer current
- Frequency range up to 3GHz
- Comparable with SO42P or TBB042G
- LO can be driven with external source or internal oscillator

#### OSCILLATOR :

- Internal biased single transistor stage
- Multi purpose operation possible (oscillator, amplifier)
- Low noise performance
- Current adjustable

### Application

- All wireless systems
- Various TV and SAT applications

### Ordering Information

Type	Ordering Code	Package
TDA 6131XS	Q67036-A1021-A702	P-TSSOP-16

# 1

## Table of Contents

<b>1</b>	<b>Table of Contents</b> .....	1-1
<b>2</b>	<b>Product Description</b> .....	2-1
2.1	Overview .....	2-2
2.2	Features .....	2-2
2.3	Application .....	2-3
2.4	Package Outlines .....	2-3
<b>3</b>	<b>Functional Description</b> .....	3-1
3.1	Pin Configuration .....	3-2
3.2	Pin Definition and Function .....	3-2
3.3	Functional Block Diagram .....	3-3
3.4	Circuit Description .....	3-4
3.4.1	MIXER .....	3-4
3.4.2	OSCILLATOR / AMPLIFIER .....	3-4
3.4.3	COMMON .....	3-4
<b>4</b>	<b>Applications</b> .....	4-1
4.1	Test Circuits .....	4-2
4.1.1	Test Circuit 1 .....	4-2
4.1.2	Test Circuit 2 .....	4-3
4.1.3	Test Circuit 3 .....	4-4
4.2	Hints .....	4-5
<b>5</b>	<b>Reference</b> .....	5-1
5.1	Absolute Maximum Ratings .....	5-2
5.2	Operating Range .....	5-3
5.3	AC/DC Characteristics .....	5-3

# 2 Product Description

## Contents of this Chapter

2.1	Overview . . . . .	2-2
2.2	Features . . . . .	2-2
2.3	Application . . . . .	2-3
2.4	Package Outlines . . . . .	2-3

## 2.1 Overview

- Functional Description, Benefits
- New B6HF bipolar technology, 25GHz ft
- Frequency range up to 3.0 GHz
- Small outline P-TSSOP 16 package
- 2.7-4.5V supply voltage
- -40°C to +85°C operational temperature range
- Standby function
- Reduced external components
- High isolation between mixer ports
- Good crosstalk performance

## 2.2 Features

### MIXER:

- Universal Gilbert cell mixer with adjustable mixer current
- Frequency range up to 3GHz
- Comparable with SO42P or TBB042G
- LO can be driven with external source or internal oscillator

### OSCILLATOR :

- Internal biased single transistor stage
- Multi purpose operation possible (oscillator, amplifier)
- Low noise performance
- Current adjustable

## 2.3 Application

- All wireless systems
- Various TV and SAT applications

## 2.4 Package Outlines

P-TSSOP-16

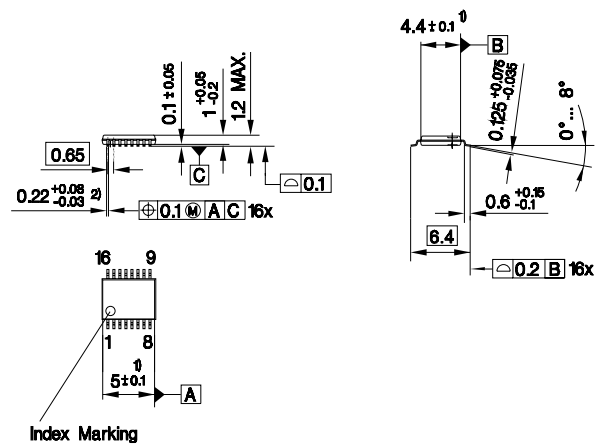

- Index Marking
- 1) Does not include plastic or metal protrusion of 0.15 max. per side
  - 2) Does not include dambar protrusion

# 3 Functional Description

## Contents of this Chapter

3.1	Pin Configuration .....	3-2
3.2	Pin Definition and Function .....	3-2
3.3	Functional Block Diagram .....	3-3
3.4	Circuit Description .....	3-4



### 3.1 Pin Configuration

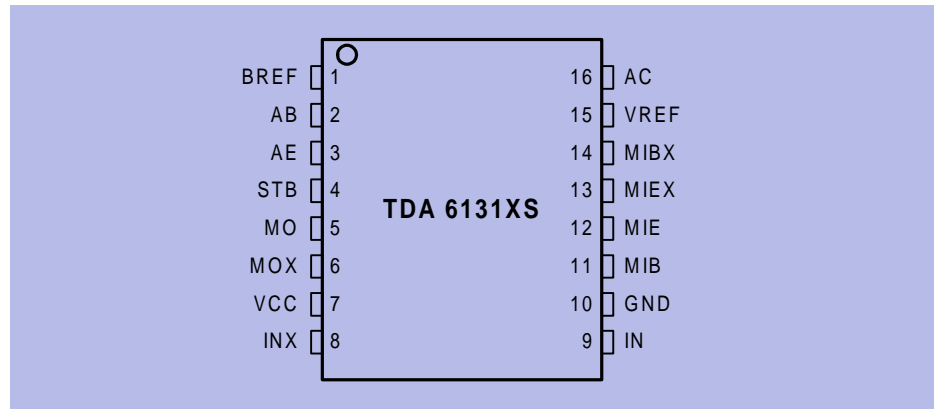

Pin\_config.wmf

Figure 3-1 Pin Configuration

### 3.2 Pin Definition and Function

Table 3-1 Pin Definition and Function			
Pin No.	Symbol	Equivalent I/O-Schematic	Function
1	BREF		Reference voltage for amplifier/oscillator $V_{BE}$
2	AB		Amplifier / Oscillator base
3	AE		Amplifier / Oscillator emitter
4	STB		Standby circuit
5	MO		Mixer signal open collector output, not inverted
6	MOX		Mixer signal open collector output, inverted,
7	VCC		Voltage supply
8	INX		Mixer signal base input, inverted
9	IN		Mixer signal base input, not inverted
10	GND		Ground
11	MIB		Mixer local oscillator base input, not inverted
12	MIE		Mixer local oscillator emitter input, not inverted
13	MIEX		Mixer local oscillator emitter input, inverted
14	MIBX		Mixer local oscillator base input, inverted
15	VREF		Constant reference voltage
16	AC		Amplifier / Oscillator collector

### 3.3 Functional Block Diagram

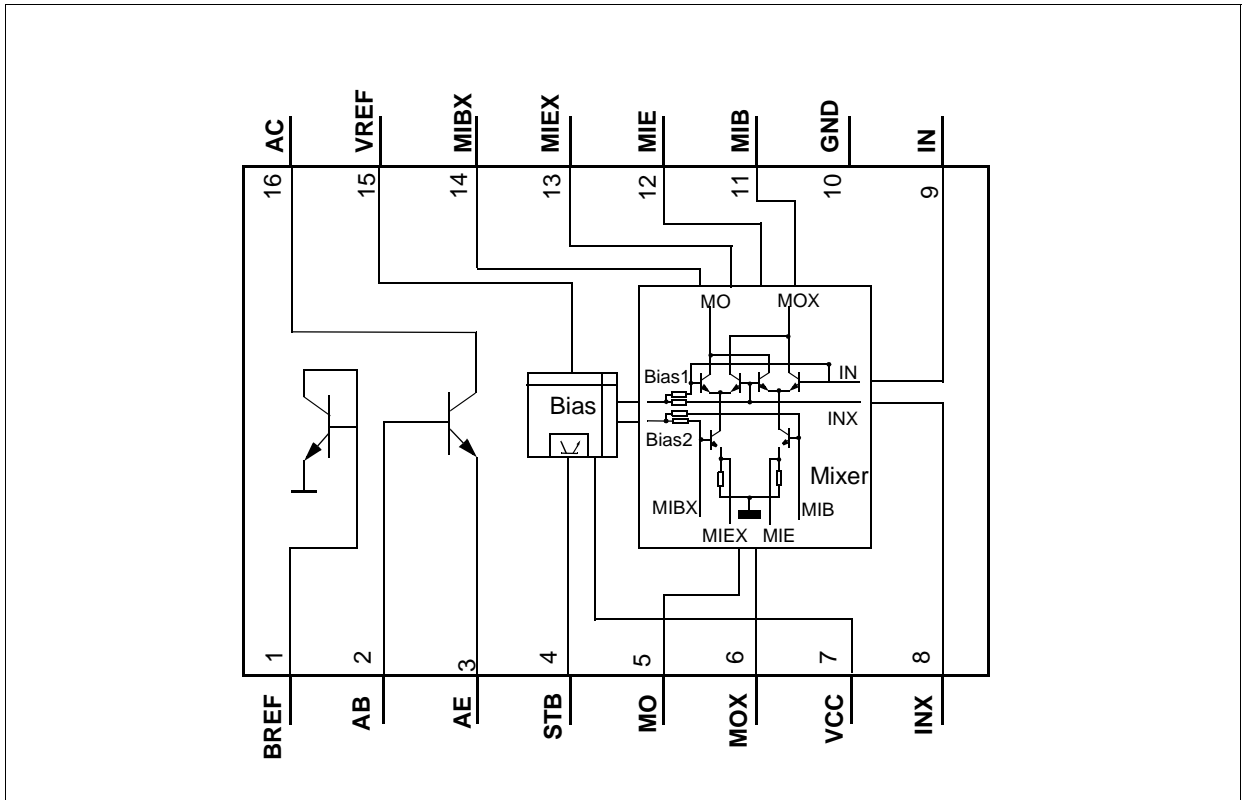

Figure 3-2 Functional Block Diagram

## 3.4 Circuit Description

### 3.4.1 MIXER

The mixer used in this design is a general purpose up-/down conversion gilbert cell mixer that can be used in various configurations. The RF can enter the IC either via the pins MIE/MIEX or via MIB/MIBX. Using an external supplied local oscillator at IN/INX a converted output signal is created at the open collector output pins MO/MOX. In a second configuration the RF should be connected to the pins IN/INX and the pins MIB/MIBX/MIE/MIEX need to be connected to an external tank circuit, thus forming for example an colpitts oscillator using the internal transistor stages. In both cases the open collector pins MO/MOX need to be connected to an external supply voltage. To improve the mixer performance external resistors at MIE/MIEX make it possible to adjust the mixer current. The RF connections to the mixer input can be single ended or balanced, capacitive or inductive. Supply voltage for the mixer has to be connected to the pin VCC and to GND.

### 3.4.2 OSCILLATOR / AMPLIFIER

Using the additional transistor stage it is possible to realize via external components an oscillator or an amplifier circuit. Base AB, emitter AE and collector AC are external available. To adjust the amplifier/oscillator current using a current mirror the internal reference voltage at VREF has to be connected to BREF with an external resistor and BREF needs to be connected to the base AB. This can be done via a resistor and/or a choke. External matching networks at the in- and output of the transistor stage will improve the amplifier performance.

### 3.4.3 COMMON

Differential signals and symmetrical circuits are used throughout the mixer part of the IC.

An internal bias driver generates supply voltage and temperature compensated reference voltages. The STB pin allows the IC to be switched in a low power mode. The pins BREF, VREF, STB, VCC, IN, INX, and MO, MOX are ESD protected.

# 4 Applications

## Contents of this Chapter

4.1	Test Circuits .....	4-2
4.1.1	Test Circuit 1.....	4-2
4.1.2	Test Circuit 2.....	4-3
4.1.3	Test Circuit 3.....	4-4
4.2	Hints .....	4-5

## 4.1 Test Circuits

### 4.1.1 Test Circuit 1

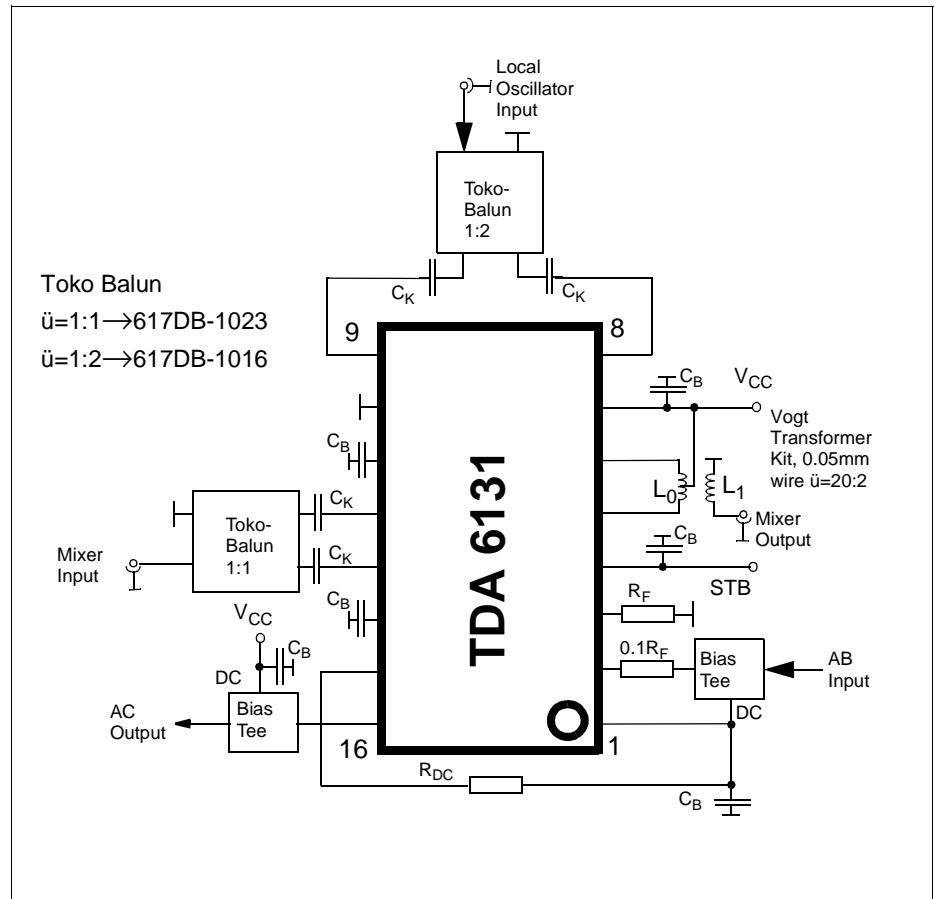

Figure 4-1 Test Circuit 1

Mixer Circuit Base Grounded,  
 Amplifier With Feedback Resistor

### 4.1.2 Test Circuit 2

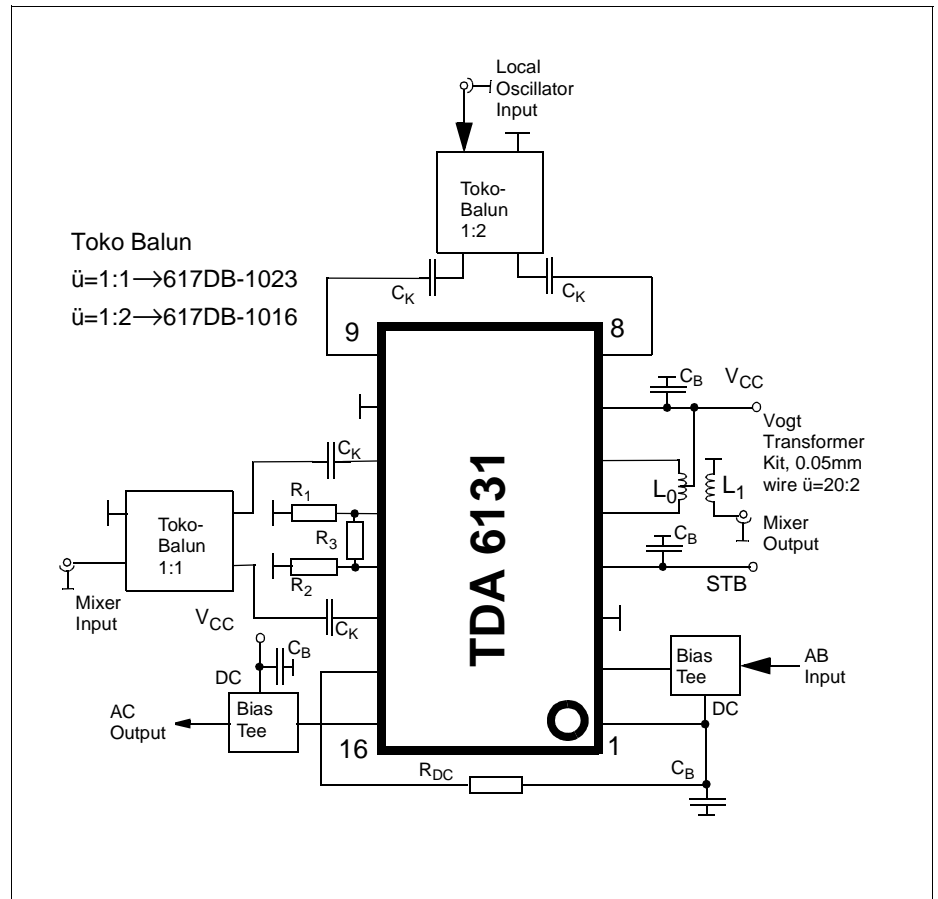

Figure 4-2 Test Circuit 2

Mixer Circuit Emitter Grounded,  
Mixer Current Increased With Resistor R<sub>1</sub>,R<sub>2</sub>

### 4.1.3 Test Circuit 3

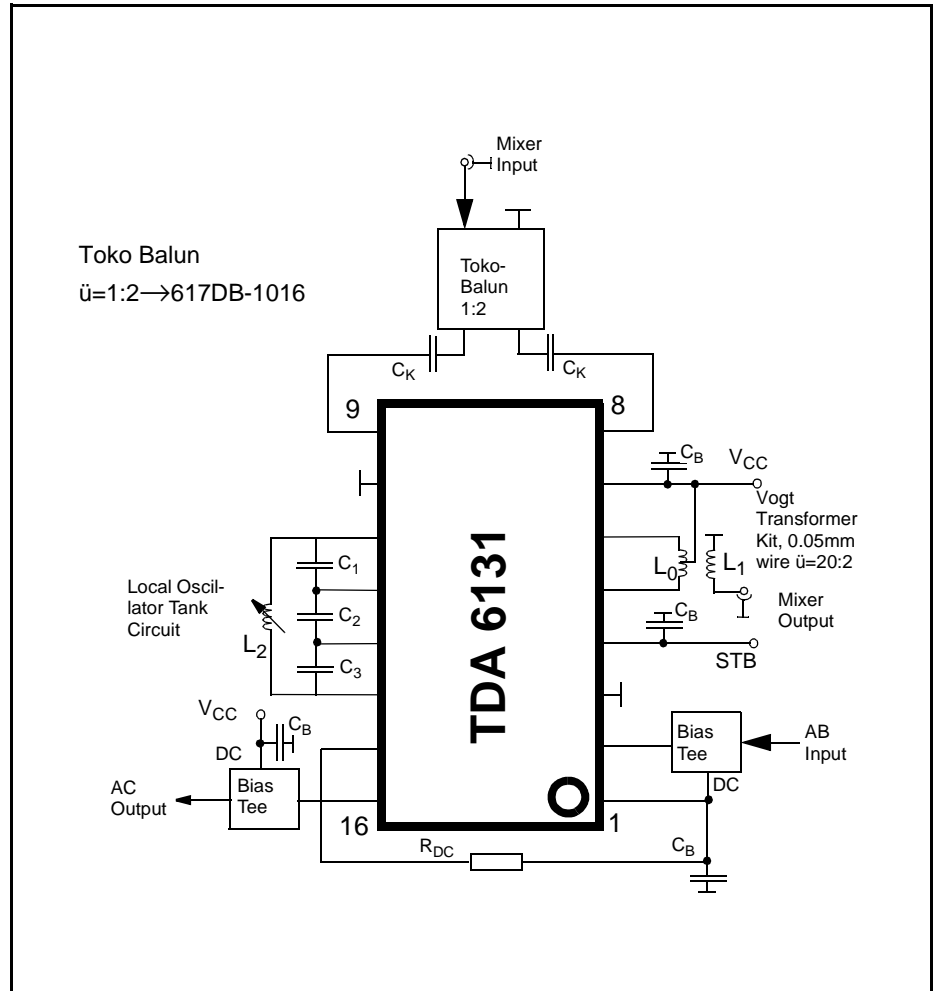

Figure 4-3 Test Circuit 3

Mixer With Internal Oscillator

## **4.2 Hints**



# 5 Reference

## Contents of this Chapter

5.1	Absolute Maximum Ratings . . . . .	5-2
5.2	Operating Range . . . . .	5-3
5.3	AC/DC Characteristics . . . . .	5-3

## 5.1 Absolute Maximum Ratings

**WARNING**

The maximum ratings may not be exceeded under any circumstances, not even momentarily and individually, as permanent damage to the IC will result.

**Table 5-1 Absolute Maximum Ratings, Ambient temperature  $T_{AMB} = -40^{\circ}\text{C} \dots + 85^{\circ}\text{C}$** 

#	Parameter	Symbol	Limit Values		Unit	Remarks
			min	max		
1	Supply Voltage	$V_S$	-0.3	5.0	V	
2	Input Voltage MIE/X	$V_{MIE/MIE X}$	-0.3	1.9	V	$V_S = 0$ , MIB/X open
3	Input Voltage MIB/X	$V_{MIB/MIB X}$	-0.3	1.9	V	
4	Input Voltage IN/INX	$V_{IN/IN X}$	0.6	$V_S + 0.3$ 5.0max.	V V	
5	Input Voltage AB	$V_{AB}$	-0.3	$V_{AC} + 0.3$ 3.5max.	V V	
6	Input Voltage AE	$V_{AE}$	-0.3	0.6	V	
7	Output Voltage VREF	$V_{VREF}$	1.3	2.0	V	
8	Input Voltage STB	$V_{STB}$	-0.3	$V_S + 0.3$ 5.0max.	V V	
9	Output Voltage BREF	$V_{BREF}$	-0.3	3.5	V	
10	Open Collector Output Voltage	$V_{MO/MOX}$	1.7	$V_S + 0.3$ 5.0max.	V V	
11	Open Collector Output Voltage	$V_{AC}$	-0.3	3.5	V	Base open
12	Open Collector Output Voltage	$V_{AC}$	-0.3	7.0	V	$R_B < 50\text{K}\Omega$
13	Amplifier / Oscillator Current	$I_{AC}$		30	mA	
14	Reference Current	$I_{BREF}$		3	mA	
15	Differential Input Voltage	$V_{DIFF}$		2.0	$V_{PP}$	
16	Junction Temperature	$T_j$		125	$^{\circ}\text{C}$	
17	Storage Temperature	$T_S$	-40	125	$^{\circ}\text{C}$	
18	Thermal Resistance	$R_{thJA}$		213	K/W	1)
19	ESD integrity, pins 1,5,6,7,8,9,15	$V_{ESD}$	-1000	1000	V	2)

1) **Attention: Do not exceed the maximum. junction temperature**

2) HBM according to MIL STD 883D, method 3015.7 and EOS/ESD Assn. Standard S5.1-1993

## 5.2 Operating Range

Within the operating range the IC operates as described in the circuit description. The AC/DC characteristic limits are not guaranteed.

**Table 5-2 Operating Range**

#	Parameter	Symbol	Limit Values		Unit	Test Conditions	L	Item
			min	max				
1	AB Input Frequency	$f_{AI}$		3000	MHz			
2	MIE/X or MIB/X Input Frequency	$f_{MI}$		3000	MHz			
3	IN/X Input Frequency	$f_{IN}$		3000	MHz			
4	MO/X Intermediate Frequency	$f_{MO}$		3000	MHz			
5	Standby Voltage On	$STB_{ON}$	2.0	$V_S$	V			
6	Standby Voltage Off	$STB_{OFF}$	0	0.5	V			

■ This value is only guaranteed in lab.

## 5.3 AC/DC Characteristics

AC/DC characteristics involve the spread of values guaranteed within the specified supply voltage and ambient temperature range. Typical characteristics are the median of the production.

**Table 5-3 AC/DC Characteristics with  $T_A$  25 °C,  $V_{VCC} = 2.7V \dots 4.5V$** 

#	Parameter	Symbol	Limit Values			Unit	Test Conditions	L	Test Circuit
			min	typ	max				
<b>Supply Current</b>									
1a	Supply current, total IC	$I_{4,5,6,7,16}$		7.8		mA	STB ON, $R_1=R_2=\infty$ $R_{DC}=820\Omega$		1, $I_{AC}=5.5mA$
1b	Supply current, total IC	$I_{4,5,6,7,16}$		13.1		mA	STB ON, $R_1=R_2=\infty$ $R_{DC}=330\Omega$		1, $I_{AC}=10mA$
1c	Supply current, total IC	$I_{4,5,6,7,16}$		11.1		mA	STB ON, $R_1=R_2=180\Omega$ $R_{DC}$ $=820\Omega$		1, $I_{AC}=5.5mA$
2	Supply current, total IC	$I_{4,5,6,7,16}$		<20		$\mu A$	STB OFF, $R_{DC}=820\Omega$		1

■ This value is only guaranteed in lab.

\* Minimum value for external resistors at MIE/MIEX:  $R_1=R_2=68\Omega$

\* Minimum value for external resistor between VREF and BREF:  $R_{DC}=180\Omega$

**Table 5-3 AC/DC Characteristics with  $T_A$  25 °C,  $V_{CC} = 2.7V \dots 4.5V$  (continued)**

#	Parameter	Symbol	Limit Values			Unit	Test Condi- tions	L	Test Circuit
			min	typ	max				
<b>Mixer, Signal Input MIE/MIEX, Downconversion, R1,2=180 <math>\Omega</math></b>									
3	Max. input level, 1db compression at MO/X, IF= 45MHz	$P_{MI}$		-15		dBm	f=0.9GHz	■	1
4	Input intercept point, $\Delta f=800kHz$ , IF= 45MHz	$IICP3_{MI}$		0		dBm	f=0.9GHz	■	1
5	Noise figure, ssb (NF <sub>ssb</sub> ≈NF <sub>dsb</sub> +3dB) IF=45MHz	$F_{MI}$		9		dB	f=0.9GHz	■	1*
<b>Mixer, Local Oscillator Input IN/INX, Downconversion, R1,2=180 <math>\Omega</math></b>									
6	Input level	$P_{LO}$		-3		dBm	f=0.9GHz		1**
<b>Mixer, Signal Output MO/MOX, Downconversion, R1,2=180 <math>\Omega</math></b>									
7	Output current	$I_{MO+MOX}$		4.0		mA	incl. R1,R2		1
8	Output resistance	$R_{MODiff}$		32		k $\Omega$	IF=45MHz	■	1
9	Output capacitance	$C_{MODiff}$		0.36		pF	IF=45MHz	■	1
10	Power gain, IF=45MHz	$P_{MI}$		15		db	f=0.9GHz	■	1

■ This value is only guaranteed in lab.

\*matching network used

\*\* referenced for specified mixer performance