

**LOW NOISE PREAMPLIFIER COMPRESSOR**

- SINGLE SUPPLY OPERATION (10 to 30V)
- HIGH SUPPLY VOLTAGE REJECTION
- COMPRESSOR FACILITY
- VERY LOW NOISE AND DISTORTION
- HIGH COMMON MODE REJECTION
- SHORT CIRCUIT PROTECTION

**DESCRIPTION**

The TDA 7232 is a preamplifier mainly intended for car-radio applications, requiring very low noise and distortion performance.

It consists of a unity gain differential input amplifier with a very high common mode rejection, a compressor which avoids the output clipping and three multipurpose operational amplifiers.

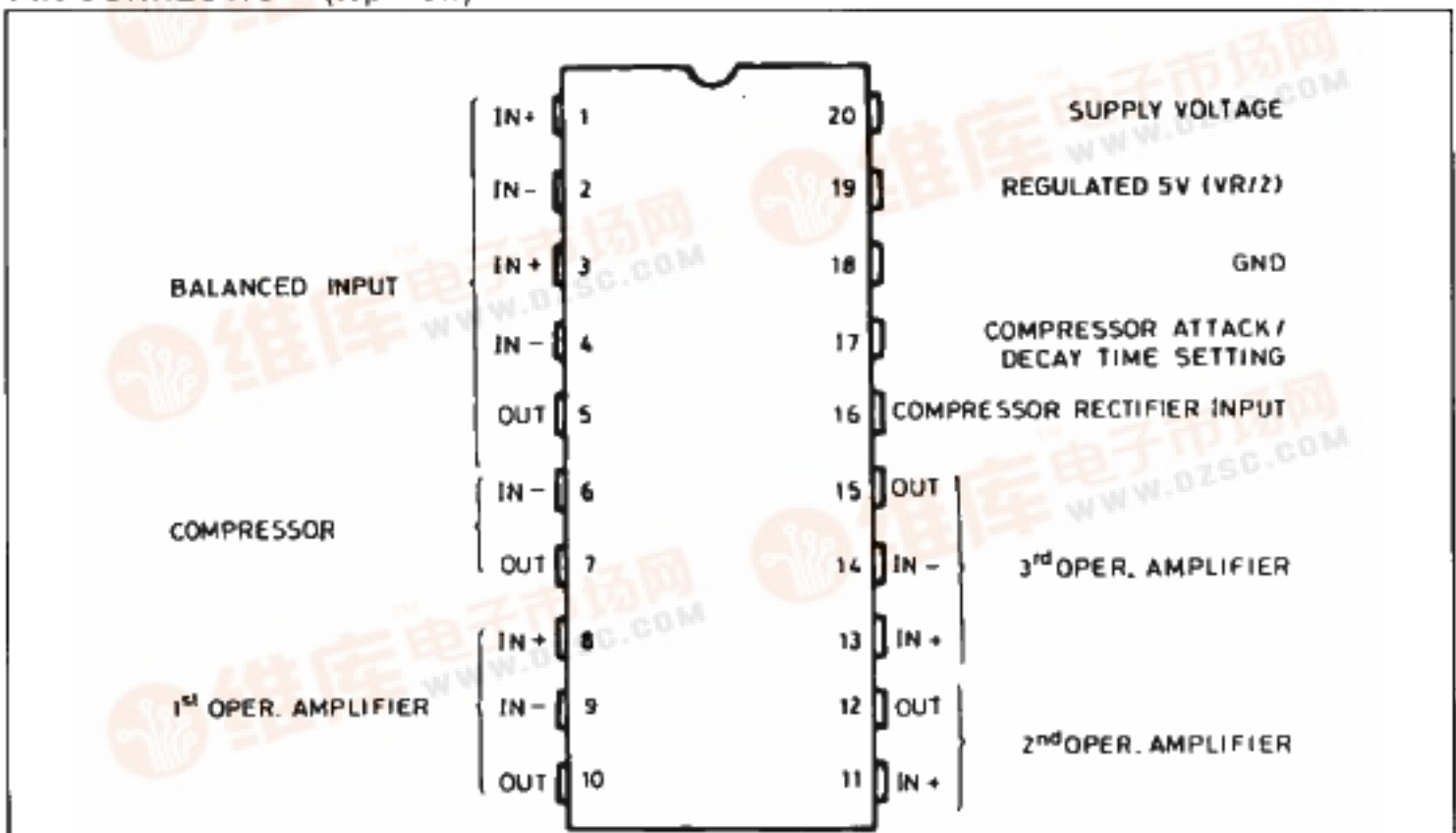
A high stability voltage regulator is also included. The TDA 7232 is assembled in a 20 lead dual in line plastic package.



**DIP-20**  
(Plastic 0.4)

**ORDER CODE : TDA7232**

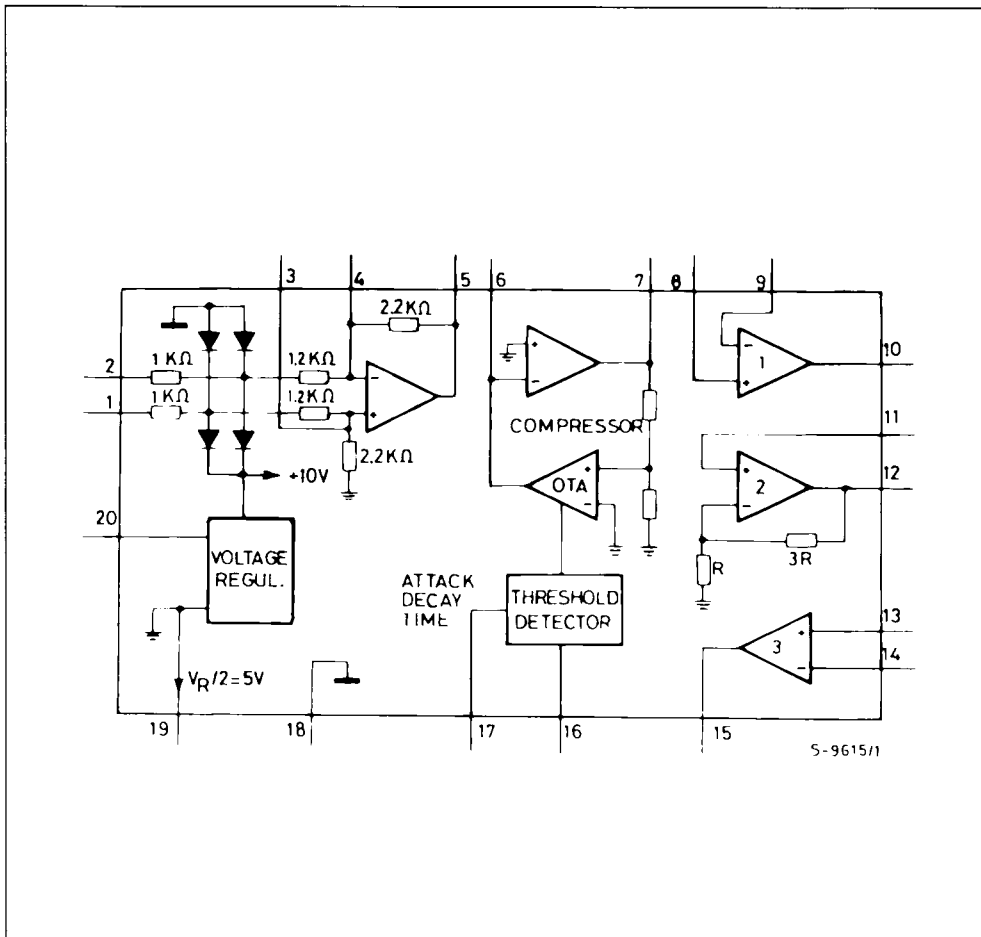
**PIN CONNECTION (top view)**



S-9584/2

## TDA7232

### BLOCK DIAGRAM



### ABSOLUTE MAXIMUM RATINGS

Symbol	Parameter	Value	Unit
$V_s$	Operating Supply Voltage	30	V
$V_s$	Peak Supply Voltage (for 50 ms)	40	V
$V_i$	Input Voltage	$\pm V_s$	
$T_{op}$	Operating Temperature	- 25 to 85	°C
$P_{tot}$	Total Power Dissipation at $T_{amb} = 70$ °C	1	W

### THERMAL DATA

$R_{th\ j-amb}$	Thermal Resistance Junction-ambient	Max	80	°C/W
-----------------	-------------------------------------	-----	----	------

## TDA7232

**ELECTRICAL CHARACTERISTICS** ( $T_{amb} = 25\text{ }^{\circ}\text{C}$ ,  $V_s = 14.4\text{ V}$ ,  $G_v = 30\text{ dB}$ , refer to test circuit amplifier fig. 1)

Symbol	Parameter	Test Conditions	Min.	Typ.	Max.	Unit
$V_s$	Supply Voltage		10		30	V
$I_s$	Supply Current			10	16	mA
$G_v$	Closed Loop Gain	Pin 1–2 to Pin 15	29	30	31	dB
d	Total Harmonic Distortion	f = 1 KHz out of Compression $V_o = 2 V_{RMS}$		0.03	0.12	%
		in compression $V_i = 0.7 V_{RMS}$		0.15	0.5	%
$V_o$	Output Volt. Swing		7.5	8.4		V
$e_N$	Total Output Noise	$R_g = 50\ \Omega$		160		$\mu\text{V}$
		B = 22 Hz to 22 KHz Curve A		120		$\mu\text{V}$
SVR	Supply Volt. Rejection (*)	$R_g = 50\ \Omega$ f = 100 Hz $V_R = 1 V_{RMS}$	90	110		dB

### INPUT DIFFERENTIAL AMPLIFIER

Symbol	Parameter	Test Conditions	Min.	Typ.	Max.	Unit
$V_{OS}$	Input Offset Voltage			1	7	mV
$G_v$	Voltage Gain	f = 20 Hz to 20 KHz	0.98	1	1.02	V/V
$e_N$	Total Input Noise Voltage	$R_g = 50\ \Omega$ ; B = 22 Hz to 22 KHz		1.5		$\mu\text{V}$
		$R_g = 50\ \Omega$ ; Curve A		1.1		$\mu\text{V}$
d	Distortion	$R_L = 2\ \text{K}\Omega$ $V_o = 1 V_{RMS}$ f = 1 KHz		0.01		%
$V_o$	Output Swing	$R_L = 2\ \text{K}\Omega$	7.5	8.4		$V_{pp}$
SR	Slew Rate			1		$\text{V}/\mu\text{S}$
CMR	Common Mode Reject.	f = 20 Hz to 20 KHz	36	50		dB

### COMPRESSOR

Symbol	Parameter	Test Conditions	Min.	Typ.	Max.	Unit
$I_b$	Input Bias Current			60	300	nA
$V_{os}$	Input Offset Voltage	$R_g \leq 10\ \text{K}\Omega$ out of Compression		1	3.5	mV
$V_{os}$	Output Offset Voltage	in Compression $V_{pin.17} = 0.7\text{ V}$			350	mV
$e_N$	Total Input Noise Voltage	$R_g = 50\ \Omega$ ; B = 22 Hz to 22 KHz		1.8		$\mu\text{V}$
		$R_g = 50\ \Omega$ ; Curve A		1.3		$\mu\text{V}$
d	Distortion	$R_L = 2\ \text{K}\Omega$ $V_o = 1 V_{RMS}$ f = 1 KHz $G_v = 20\text{ dB}$		0.01		%
SVR	Supply Voltage Rejection	$V_R = 1\text{ V}$ , f = 100 Hz, $R_g = 50\ \Omega$	86			dB

(\*) Referred to the input.

## TDA7232

### ELECTRICAL CHARACTERISTICS (continued)

Symbol	Parameter	Test Conditions	Min.	Typ.	Max.	Unit
$V_o$	DC Output Voltage Swing	$R_L = 2\text{ K}\Omega$	7.5	8.4		V
SR	Slew Rate			0.7		V/ $\mu$ S

### 1st AND 3rd OPERATION AMPLIFIER

Symbol	Parameter	Test Conditions	Min.	Typ.	Max.	Unit
$I_b$	Input Bias Current			60	300	nA
$I_{os}$	Input Offset Current			20	50	nA
$V_{os}$	Input Offset Voltage	$R_g \leq 10\text{ K}\Omega$		1	3.5	mV
CMR	Common Mode Rejection		86			dB
SVR	Supply Voltage Rejection	$V_R = 1\text{ V}$ , $f = 100\text{ Hz}$ , $R_g = 50\ \Omega$	86			dB
$e_N$	Total Input Noise Voltage	$R_g = 50\ \Omega$ ; $B = 22\text{ Hz to }22\text{ KHz}$		1.4		$\mu$ V
		$R_g = 50\ \Omega$ ; Curve A		1.1		$\mu$ V
$V_o$	Output Voltage Swing	$R_L = 2\text{ K}\Omega$	7.5	8.4		$V_{pp}$
d	Total Harmonic Distortion	$R_L = 2\text{ K}\Omega$ , $V_o = 1\text{ V}_{RMS}$ $f = 1\text{ KHz}$ , $G_v = 20\text{ dB}$		0.01		%
$G_v$	Open Loop Gain	$R_L = 2\text{ K}\Omega$	86	100		dB
SR	Slew Rate	$R_L = 2\text{ K}\Omega$		1		V/ $\mu$ S

### 2nd OPERATIONAL AMPLIFIER ( $G_v = 12\text{ dB}$ internally set)

Symbol	Parameter	Test Conditions	Min.	Typ.	Max.	Unit
$V_{os}$	Output Offset Voltage			4	15	mV
SVR	Supply Voltage Rejection	$V_R = 1\text{ V}$ , $f = 100\text{ Hz}$	86			dB
$e_N$	Total Input Noise Voltage	$R_g = 50\ \Omega$ ; $B = 22\text{ Hz to }22\text{ KHz}$		2.2		$\mu$ V
		$R_g = 50\ \Omega$ ; Curve A		1.4		$\mu$ V
$V_o$	DC Output Voltage Swing	$R_L = 2\text{ K}\Omega$	7.5	8.4		V
d	Total Harmonic Distortion	$R_L = 2\text{ K}\Omega$ , $f = 1\text{ KHz}$ $V_o = 1\text{ V}_{RMS}$		0.01		%
$G_v$	Voltage Gain	$f = 20\text{ Hz to }20\text{ KHz}$	11.5	12	12.5	dB
SR	Slew Rate	$R_L = 2\text{ K}\Omega$		1		V/ $\mu$ S

### VOLTAGE REGULATOR

Symbol	Parameter	Test Conditions	Min.	Typ.	Max.	Unit
$V_o$	Output Voltage	Pin 19 $I_{sink, source}$ from 0 to 12 mA	4.6	5	5.4	V
$I_o$	Output Max. Current	$I_{source}$		12		mA
		$I_{sink}$		12		mA

Figure 1 : Test Circuit.

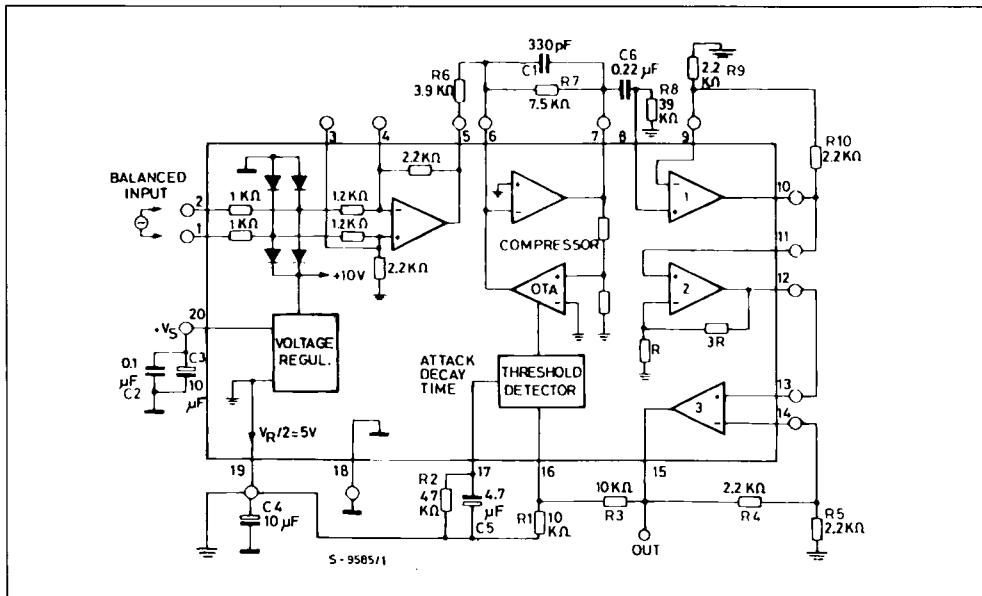
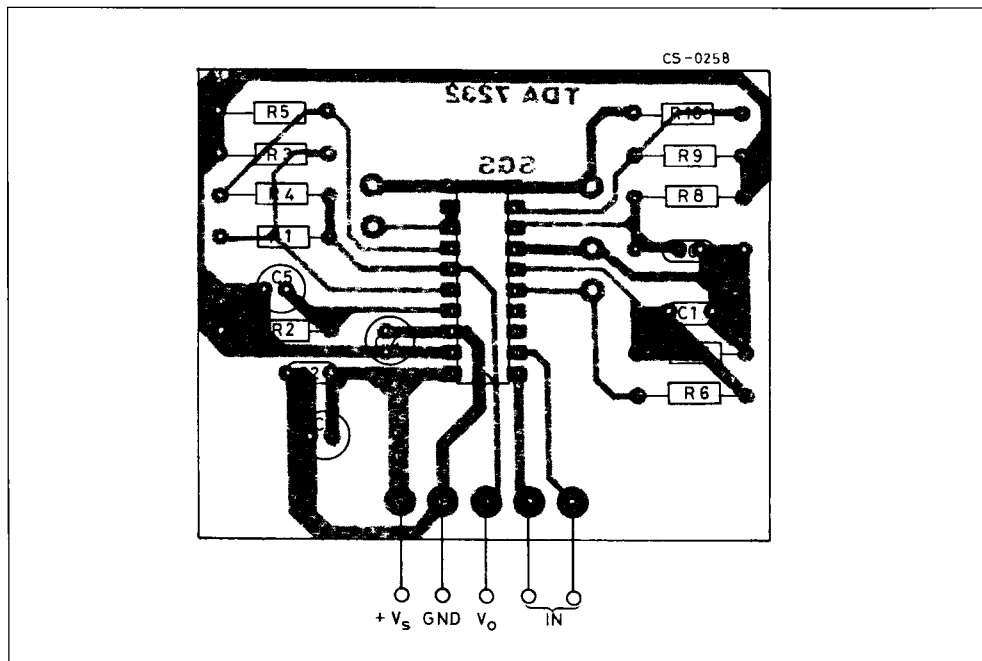


Figure 2 : P.C. Board and Components Layout of the Test Circuit of Fig. 1 (1 : 1 scale).



TDA7232

Figure 3 : Supply Current vs. Supply Voltage (complete test circuit).

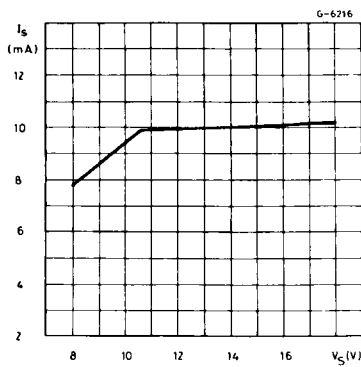


Figure 4 : Compression Characteristics.

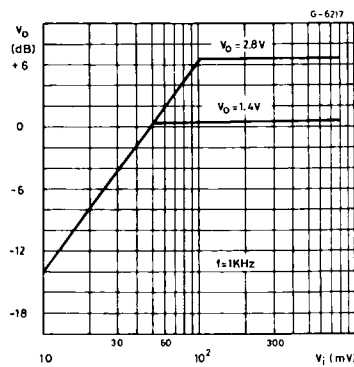


Figure 5 : Distortion vs. Frequency (complete test circuit).

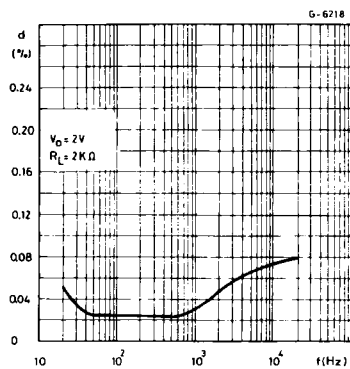


Figure 6 : Distortion vs. Input Signal Level (complete test circuit).

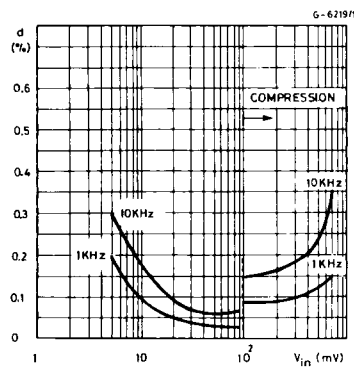


Figure 7 : Supply Voltage Rejection vs. Frequency (complete test circuit).

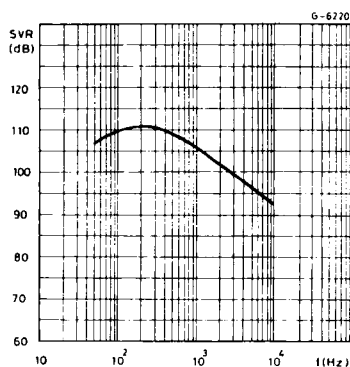
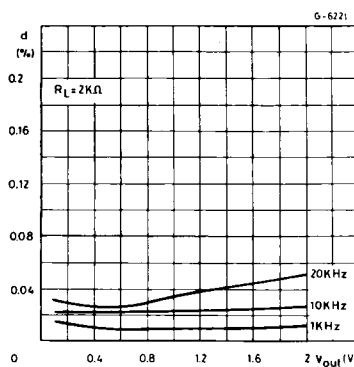
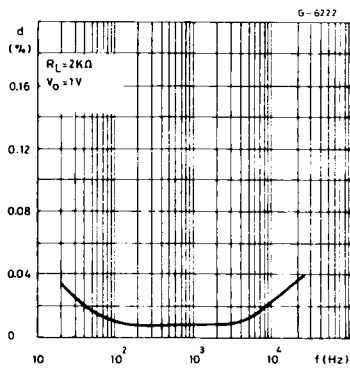


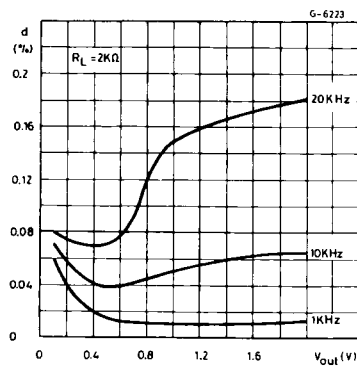
Figure 8 : Distortion vs. Output Voltage (input differ. amplifier).



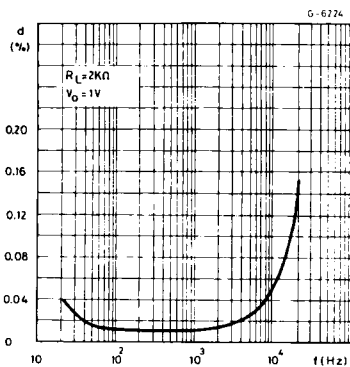
**Figure 9 :** Distortion vs. Frequency (input differ. amplifier).



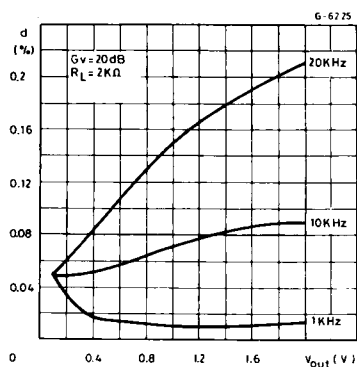
**Figure 10 :** Distortion vs. Output Voltage (compressor).



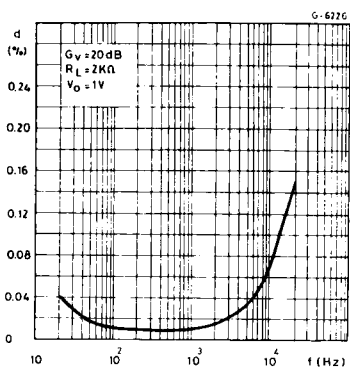
**Figure 11 :** Distortion vs. Frequency (compressor).



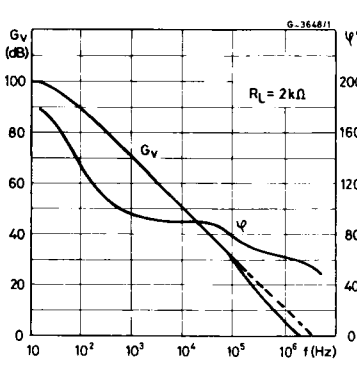
**Figure 12 :** Distortion vs. Output Voltage (op. amp. 1 & 3).



**Figure 13 :** Distortion vs. Frequency (op. amp. 1 & 3).

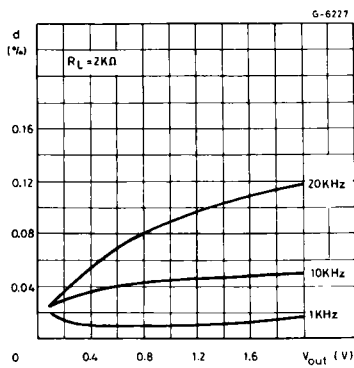


**Figure 14 :** Open Loop Frequency and Phase Response (op. amp. 1 & 3).

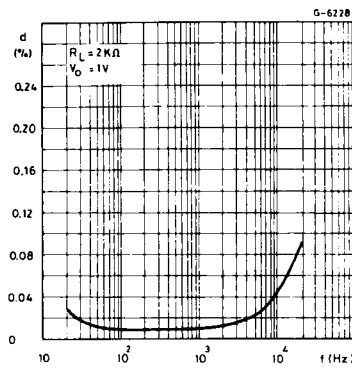


## TDA7232

**Figure 15** : Distortion vs. Output Voltage  
(op. amp. 2).



**Figure 16** : Distortion vs. Frequency  
(op. amp. 2).



### APPLICATION INFORMATION

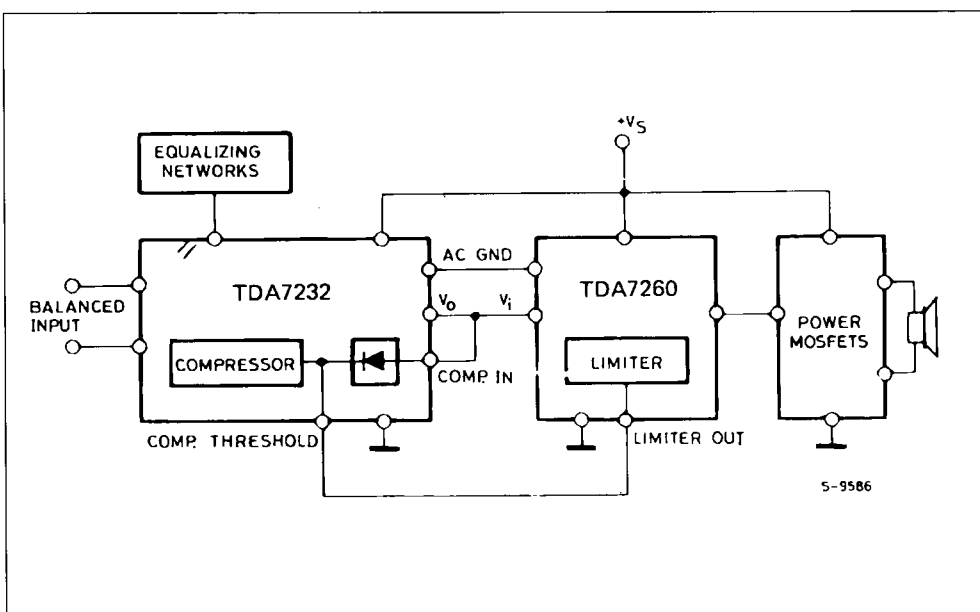
The devices TDA7232 and TDA7260 realize with four external POWER MOS an exclusive audio system for car radio, thanks to their unique feature as:

- 25 W output power ( $d = 0.3\%$ ) without heatsink, thanks to the extra-high efficiency (85 % typ. at rated output power) of the power stage, which operates in class "D" (pulse width modulation).
- In-car frequency response compensation,

thanks to the availability of several operational amplifiers for the necessary equalization.

- High-quality sound at all listening levels, thanks to an appropriate compressor circuit that avoids clipping in the system.
- Low distortion, low noise, fully protected operation of the whole system.

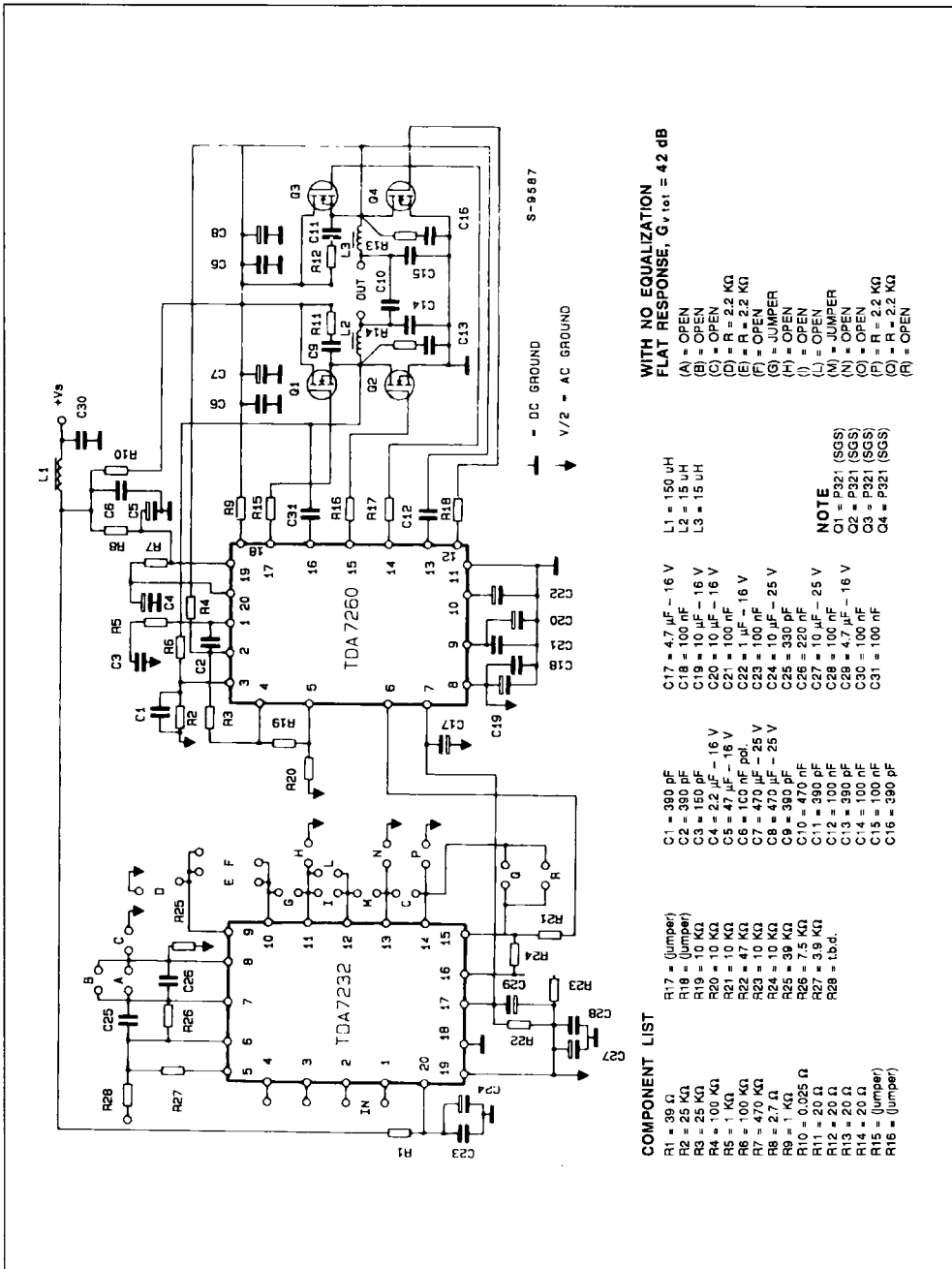
**Figure 17** : Suggested Application Using the TDA7260 Audio PWM Amplifier.





# TDA7232

Figure 18 : 25 W Application Circuit Using the TDA7260 Audio PWM.



- COMPONENT LIST**
- R1 = 20 Ω
  - R2 = 25 KΩ
  - R3 = 25 KΩ
  - R4 = 100 KΩ
  - R5 = 1 KΩ
  - R6 = 100 KΩ
  - R7 = 470 KΩ
  - R8 = 27 Ω
  - R9 = 1 KΩ
  - R10 = 0.025 Ω
  - R11 = 20 Ω
  - R12 = 20 Ω
  - R13 = 20 Ω
  - R14 = 20 Ω
  - R15 = (Jumper)
  - R16 = (Jumper)
  - R17 = (Jumper)
  - R18 = (Jumper)
  - R19 = 10 KΩ
  - R20 = 10 KΩ
  - R21 = 10 KΩ
  - R22 = 47 KΩ
  - R23 = 10 KΩ
  - R24 = 10 KΩ
  - R25 = 39 KΩ
  - R26 = 7.5 KΩ
  - R27 = 3.9 KΩ
  - R28 = t.b.d.
  - C1 = 390 pF
  - C2 = 330 pF
  - C3 = 150 pF
  - C4 = 2.2 μF - 16 V
  - C5 = 47 μF - 16 V
  - C6 = 100 nF
  - C7 = 470 μF - 25 V
  - C8 = 470 μF - 25 V
  - C9 = 390 pF
  - C10 = 470 nF
  - C11 = 390 pF
  - C12 = 100 nF
  - C13 = 390 pF
  - C14 = 100 nF
  - C15 = 100 nF
  - C16 = 390 pF
  - C17 = 4.7 μF - 16 V
  - C18 = 100 nF
  - C19 = 10 μF - 16 V
  - C20 = 10 μF - 16 V
  - C21 = 100 nF
  - C22 = 1 μF - 16 V
  - C23 = 100 nF
  - C24 = 10 μF - 25 V
  - C25 = 330 pF
  - C26 = 220 nF
  - C27 = 10 μF - 25 V
  - C28 = 100 nF
  - C29 = 4.7 μF - 16 V
  - C30 = 100 nF
  - C31 = 100 nF
  - L1 = 150 μH
  - L2 = 15 μH
  - L3 = 15 μH
- NOTE**
- O1 = P321 (SGS)
  - O2 = P321 (SGS)
  - O3 = P321 (SGS)
  - O4 = P321 (SGS)
- WITH NO EQUALIZATION,  $G_{v, tot} = 42$  dB**
- (A) = OPEN
  - (B) = OPEN
  - (C) = OPEN
  - (D) = R = 2.2 KΩ
  - (E) = R = 2.2 KΩ
  - (F) = OPEN
  - (G) = JUMPER
  - (H) = OPEN
  - (I) = OPEN
  - (L) = OPEN
  - (M) = JUMPER
  - (N) = OPEN
  - (O) = OPEN
  - (P) = R = 2.2 KΩ
  - (Q) = R = 2.2 KΩ
  - (R) = OPEN

TDA7232

Figure 19 : P.C. Board and Components Layout for the Circuit of Fig. 18 (1 : 1 scale).

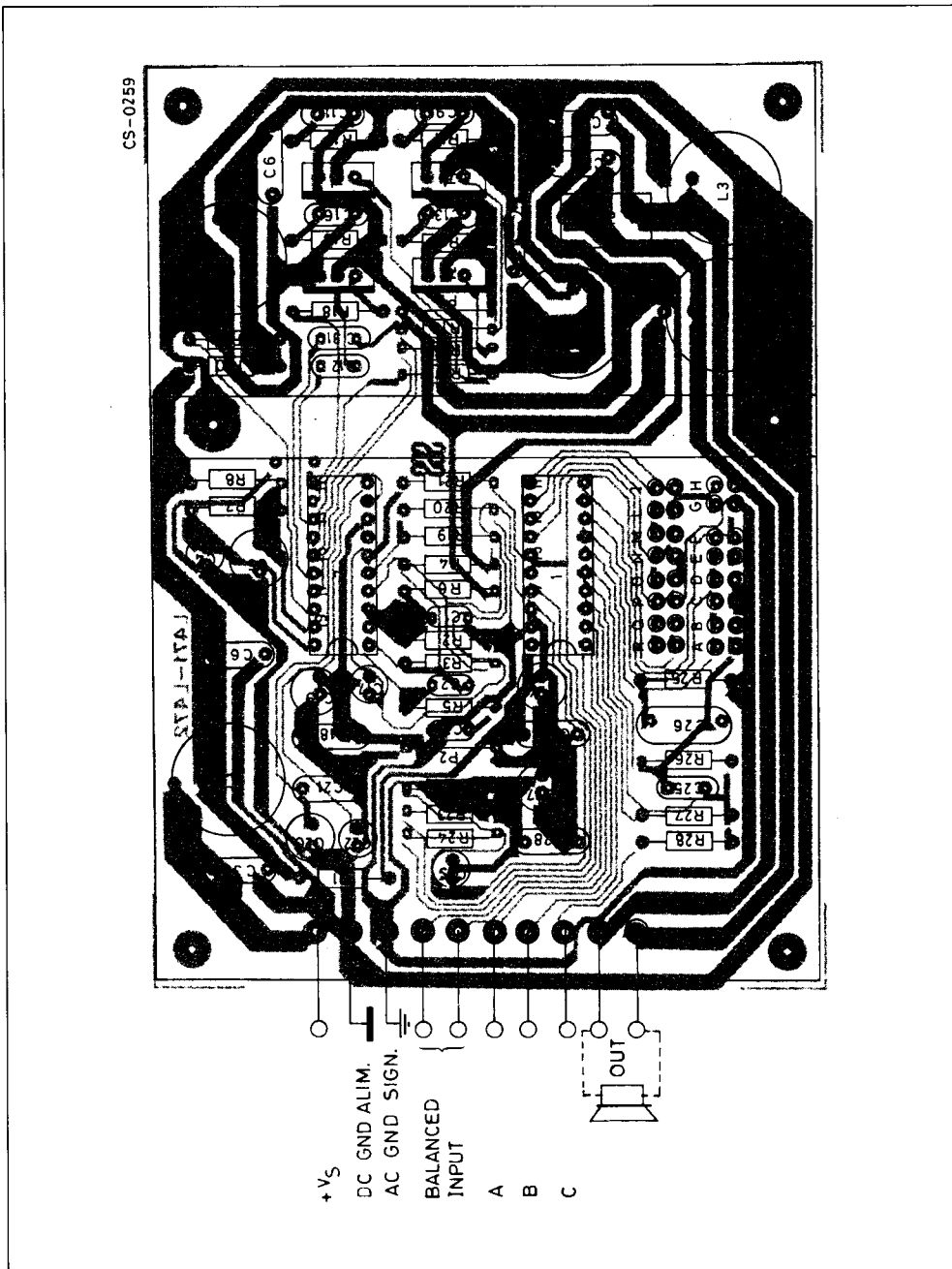
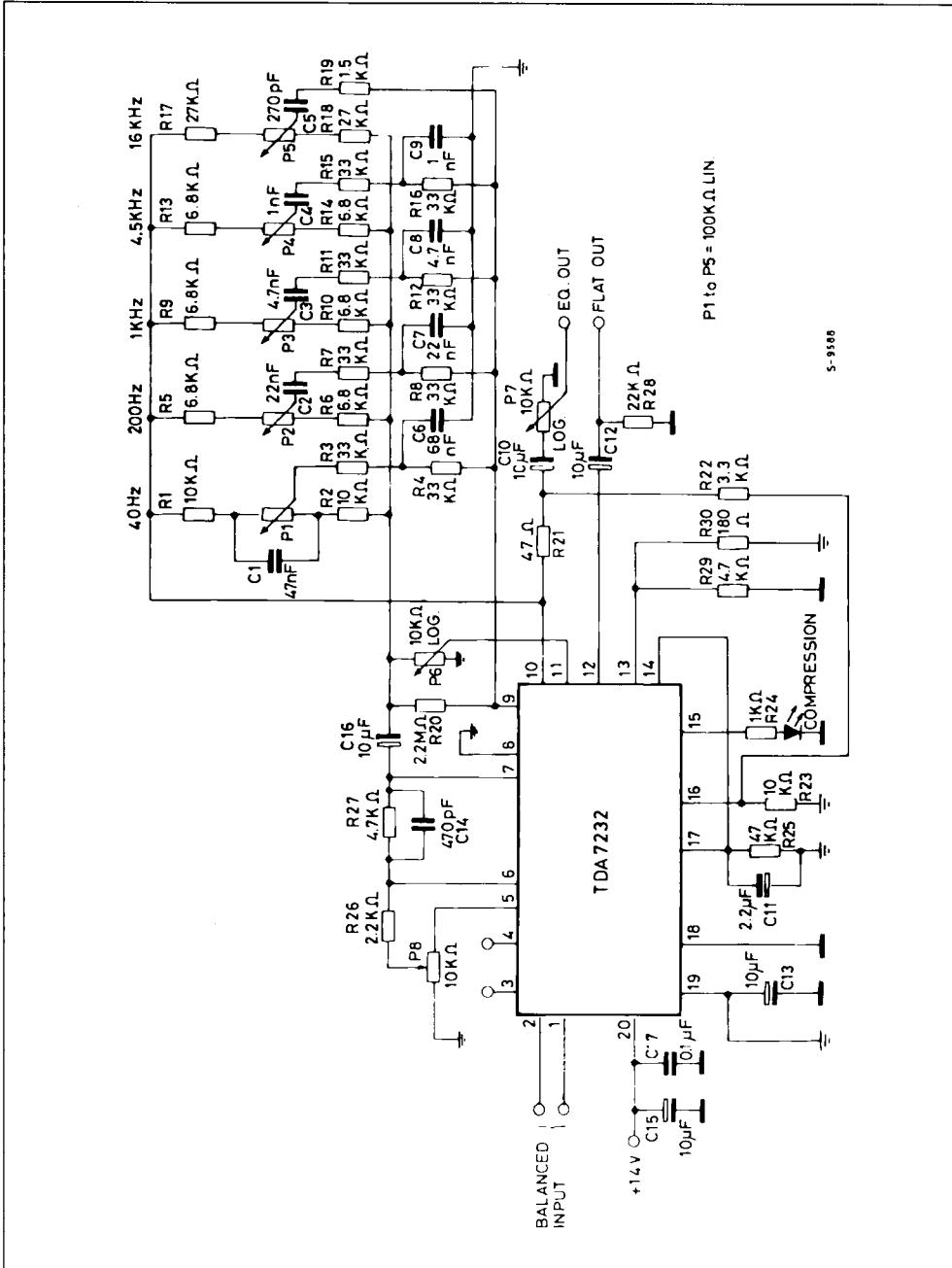


Figure 20 : Five Bands Equalizer with Compression Indicator.



TDA7232

Figure 21 : P.C. and Components Layout for the Circuit of Fig. 20 (1 : 1 scale).

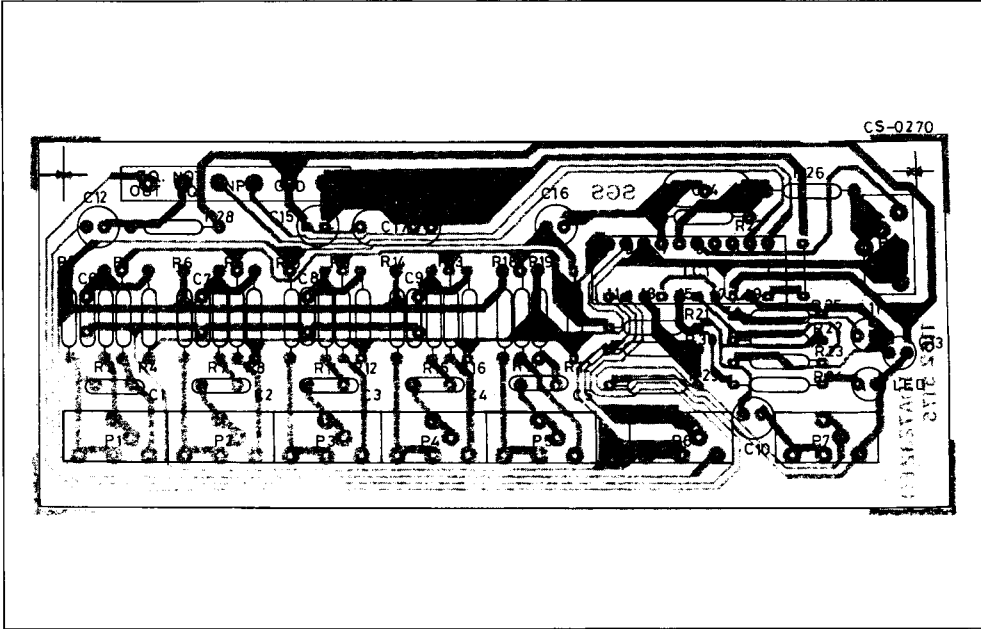


Figure 22 : Frequency Response of the five Bands Equalizer Circuit.

