



TDA7340

AUDIO SIGNAL PROCESSOR

AUDIOPROCESSOR:

- MUTE, SOFT MUTE AND ZERO CROSSING MUTE
- ONE DIFFERENTIAL, TWO STEREO AND TWO MONO INPUTS
- DIFFERENTIAL PHONE INPUT
- VOLUME, BASS, TREBLE AND LOUDNESS CONTROL
- FOUR SPEAKER ATTENUATORS WITH INDEPENDENT ATTENUATION CONTROL

STEREODECODER:

- ADJUSTMENT FREE INTEGRATED 456KHz VCO
- HIGH CUT CONTROL
- STEREO BLEND

NOISE BLANKER:

- INTEGRATED HIGH-PASS FILTER
- NOISE RECTIFIER OUTPUT FOR QUALITY DETECTION
- PROGRAMMABLE TRIGGER THRESHOLD

PAUSE DETECTOR:

- PROGRAMMABLE THRESHOLD

ALLFUNCTIONS PROGRAMMABLE VIA I²C BUS

DESCRIPTION

The TDA7340 I²C bus controlled audio signal processor contains all signal processing blocks of a high performance car radio, including audio-processor, stereodecoder, noise blanker, pause

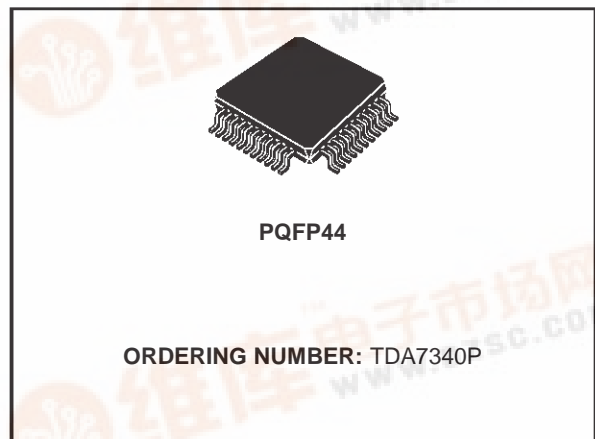

detector and different mute functions.

The use of BICMOS technology allows the implementation of several filter functions with switched capacitor techniques like fully integrated, adjustment free PLL Loop filter, pilot detector with integrator and two 19KHz notch filters.

This minimizes the number of external components.

Due to a highly linear signal processing, using CMOS-switching techniques instead of standard bipolar multipliers, very low distortion and very low noise are obtained also in the stereodecoder part. The audioprocessor contains several new features like softmute, zero-crossing mute and pause detector.

Very low Dc stepping is obtained by use of a BICMOS technology.

TDA7340

AUDIO PROCESSOR PART

FEATURES:

Input Multiplexer:

- DIFFERENTIAL CD STEREO INPUT
- CASSETTE STEREO INPUT
- FM STEREO INPUT FROM STEREO DECODER
- AM INPUT:
MONO OR STEREO MODE (PROGRAMMABLE)
- BEEP INPUT (ONLY IN AM MONO MODE)
- TELEPHONE DIFFERENTIAL MONO INPUT
- GAIN PROGRAMMABLE IN 3 x 3.75dB STEPS

Loudness:

- FULLY PROGRAMMABLE
- 15 x 1.25dB STEPS

Volume Control:

- 1.25dB COARSE ATTENUATOR
- 0.31dB FINE ATTENUATORS
- MAX GAIN 20dB
- MAX ATTENUATION 59.7dB (PLUS LOUDNESS)

Bass Control

- ± 7 x 2dB STEPS
- 2nd ORDER SYMMETRICAL OR NON SYMMETRICAL FREQUENCY RESPONSE (PROGRAMMABLE)

Treble Control

± 7 x 2dB STEPS

Speaker Control

- 4 INDEPENDENT SPEAKER CONTROL IN 1.25dB STEPS
- CONTROL RANGE 37.5dB
- INDEPENDENT SPEAKER MUTE

Mute Functions

- DIRECT MUTE

- ZERO CROSSING MUTE WITH PROGRAMMABLE THRESHOLD
- SOFT MUTE WITH EXTERNAL DEFINED SLOPE

Pause Detector

- PROGRAMMABLE THRESHOLD
- DELAY TIME DEFINED BY AN EXTERNAL CAPACITOR

STEREO DECODER PART

FEATURES:

- INTEGRATED 19KHZ NOTCH FILTER FOR PILOT CANCELLATION
- ON CHIP FILTER FOR PILOT DETECTOR AND PLL
- ADJUSTMENT FREE VOLTAGE CONTROLLED OSCILLATOR
- AUTOMATIC PILOT DEPENDENT MONO/STEREO SWITCHING
- VERY HIGH INTERMODULATION AND INTERFERENCE SUPPRESSION
- I²C BUS CONTROLLED (STD OFF, FORCED MONO, STEREO)
- HIGH CUT CONTROL
- STEREO BLEND

NOISE BLANKER PART

FEATURES:

- INTERNAL 2nd ORDER HIGH-PASS FILTER
- NOISE RECTIFIER OUTPUT FOR SIGNAL QUALITY DETECTION
- PROGRAMMABLE TRIGGER THRESHOLD
- TRIGGER THRESHOLD DEPENDENT ON HIGH FREQUENCY NOISE
- BLANKING TIME PROGRAMMABLE BY EXTERNAL CAPACITOR
- VERY LOW OFFSET CURRENT DURING HOLD TIME DUE TO OPAMPS WITH MOS INPUTS
- LEVEL INPUT FOR ADDITIONAL SPIKE DETECTION ON FIELD STRENGTH

BLOCK DIAGRAM

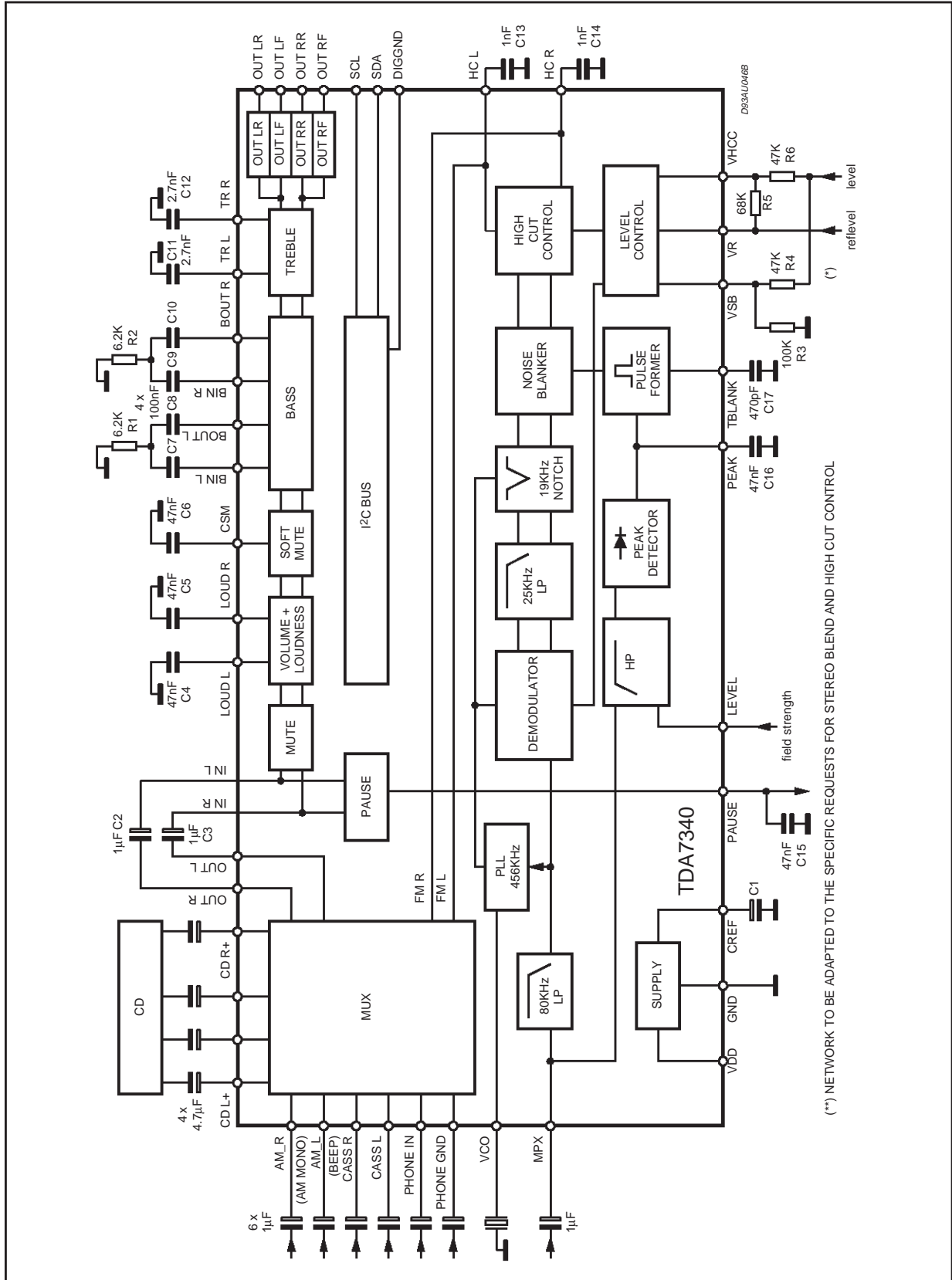

(**) NETWORK TO BE ADAPTED TO THE SPECIFIC REQUESTS FOR STEREO BLEND AND HIGH CUT CONTROL

TDA7340

ABSOLUTE MAXIMUM RATINGS

Symbol	Parameter	Value	Unit
V _s	Operating Supply Voltage	10.5	V
T _{amb}	Operating Temperature Range	-40 to 85	°C
T _{stg}	Storage Temperature Range	-55 to 150	°C

PIN CONNECTION

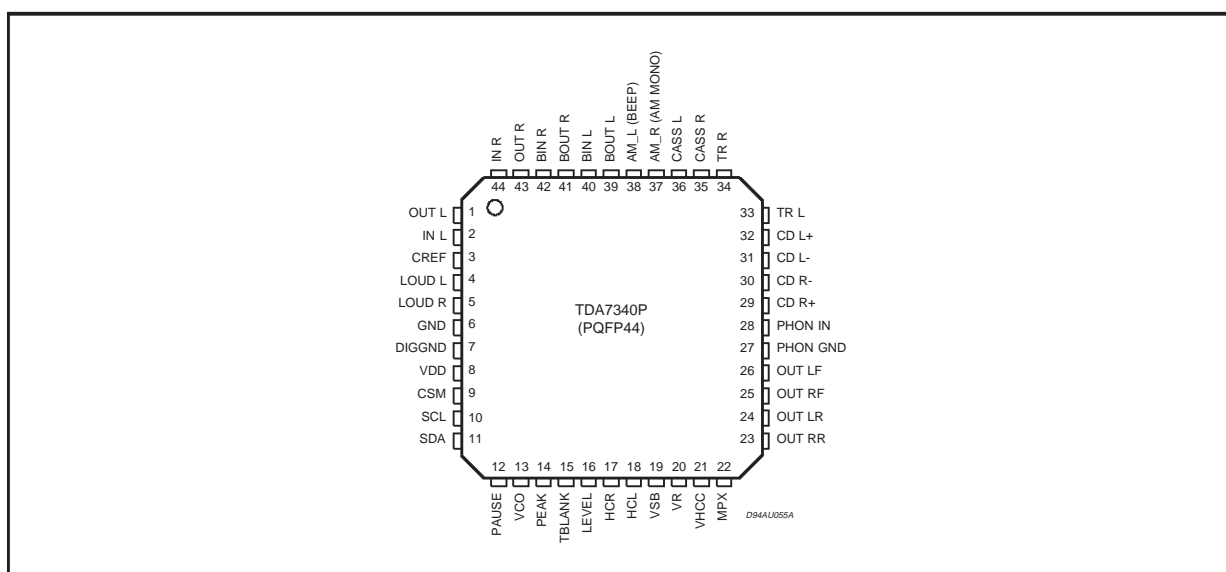

THERMAL DATA

Symbol	Parameter	Value	Unit
R _{thj-pins}	Thermal Resistance Junction-pins	max 85	°C/W

ELECTRICAL CHARACTERISTICS (V_s = 9V; T_{amb} = 25°C; R_L = 10KΩ; all gains = 0dB; f = 1KHz; unless otherwise specified, refer to the Test Circuit.)

Symbol	Parameter	Test Condition	Min.	Typ.	Max.	Unit
SUPPLY						
V _s	Supply Voltage		6	9	10	V
I _s	Supply Current	Stereo Decoder = ON	10	20	25	mA
		Stereo Decoder = OFF	5	12.5	20	mA
SVR	Ripple Rejection	Audioprocessor		90		dB
		Stereo Decoder + Audioprocessor		55		dB
INPUT SECTION						
R _I	Input Resistance		70	100	130	KΩ
V _{CL}	Clipping Level	d ≤ 0.3%	2.1	2.6		V _{rms}
S _I	Input Separation		80	100		dB
R _L	Output Load Resistance		2			KΩ
G _{I MIN}	Minimum Input Gain		-0.75	0	0.75	dB
G _{I MAX}	Max Input Gain		10.25	11.25	12.25	dB
G _{STEP}	Step Resolution		2.75	3.75	4.75	dB
e _{IN}	Input Noise	Single Ended Input		2.3		μV
V _{DC}	Dc Steps	Adjacent Gain Step		2	10	mV
		G _{MIN} to G _{MAX}		3		mV

ELECTRICAL CHARACTERISTICS (continued.)

Symbol	Parameter	Test Condition	Min.	Typ.	Max.	Unit
DIFFERENTIAL CD STEREO INPUT						
R _I	Input Resistance	Input selector BIT D6 = 0 (0dB)	10	15	20	K Ω
		Input selector BIT D6 = 1(-6dB)	14	20	30	K Ω
CMRR	Common Mode Rejection Ratio	V _{CM} = 1V _{RMS} ; f = 1KHz f = 10KHz	48	75		dB
			45	70		dB
d	Distortion	V _I = 1V _{RMS}		0.01	0.08	%
e _{IN}	Input Noise	20Hz to 20KHz; Flat; D6 = 0		5		μ V
G _{DIFF}	Differential Gain	D6 = 0	-1	0	1	dB
		D6 = 1	-7	-6	-5	dB
DIFFERENTIAL TELEPHONE MONO INPUT						
R _I	Input Resistance		14	20	26	K Ω
CMRR	Common Mode Rejection Ratio	V _{CM} = 1V _{RMS} ; f = 1KHz	45	60		dB
d	Distortion	V _I = 1V _{RMS}		0.15	0.5	%
e _{IN}	Input Noise	20Hz to 3 KHz; Flat		10		μ V
G _{DIFF}	Differential Gain		-4.75	-3.75	-2.75	dB
VOLUME CONTROL						
R _I	Input Resistance (INR, INL)		24	35	46	K Ω
C _{MAX}	Max Gain		18.75	20	21.25	dB
A _{MAX}	Max Attenuation		57.7	59.7	62.7	dB
A _{STEP} C	Step Resolution Coarse Attenuation		0.50	1.25	2.00	dB
A _{STEP} F	Step Resolution Fine Attenuation		0.11	0.31	0.51	dB
E _A	Attenuation Set Error	G = -20 to 20dB	-1.25	0	1.25	dB
		G = -20 to -59.7dB	3		2	dB
E _T	Tracking Error				2	dB
V _{DC}	DC Steps	Adjacent Attenuation Steps	-3	0.1	3	mV
		from 0dB to A _{MAX}		0.5	5	mV
LOUDNESS CONTROL (LOUDL, LOUDR)						
R _I	Internal Resistance		35	50	65	K Ω
A _{STEP}	Step Resolution		0.5	1.25	2.0	dB
A _{MAX}	Max Attenuation		17.5	18.75	20.0	dB
ZERO CROSSING MUTE						
V _{TH}	Zero Crossing Threshold (1)	WIN = 11		20		mV
		WIN = 10		40		mV
		WIN = 01		80		mV
		WIN = 00		160		mV
A _{MUTE}	Mute Attenuation		80	100		dB
V _{DC}	DC Step	0dB to Mute		0.3	3	mV
SOFT MUTE						
A _{MUTE}	Mute Attenuation		45	60		dB
t _D	Delay Time	C _{EXT} = 22nF; 0 to -20dB; I = I _{MAX} I = I _{MIN}	0.8	1.5	2.0	ms
			15	25	45	ms

(1) WIN represents the MUTE programming bit pair D6,D5 for the zero crossing window threshold

TDA7340

ELECTRICAL CHARACTERISTICS (continued.)

Symbol	Parameter	Test Condition	Min.	Typ.	Max.	Unit
BASS CONTROL						
C _{RANGE}	Control Range		±11.5	±14	±16	dB
A _{STEP}	Step Resolution		1	2	3	dB
R _B	Internal Feedback Resistance		35	50	65	KΩ
TREBLE CONTROL						
C _{RANGE}	Control Range		±13	±14	±15	dB
A _{STEP}	Step Resolution		1	2	3	dB
SPEAKER ATTENUATORS						
C _{RANGE}	Control Range		35.0	37.5	40.0	dB
A _{STEP}	Step Resolution		0.5	1.25	2.0	dB
A _{MUTE}	Output Mute Attenuation	Data Word = 38.75dB	80	100		dB
E _A	Attenuation Set Error				1.50	dB
V _{DC}	DC Step	Adjacent Attenuation Steps		0.1	3	mV
AUDIO OUTPUTS						
V _{CLIP}	Clipping Level	d = 0.3%	2.1	2.6		V _{RMS}
R _L	Output Load Resistance		2			KΩ
R _{OUT}	Output Impedance			30	100	Ω
V _{DC}	DC Voltage Level		3.5	3.8	4.1	V
PAUSE DETECTOR						
V _{TH}	Zero Crossing Threshold (1)	WIN = 11		20		mV
		WIN = 10		40		mV
		WIN = 01		80		mV
		WIN = 00		160		mV
I _{DELAY}	Pull-up Current		15	25	35	μA
V _{THP}	Pause Threshold			3.0		V
GENERAL						
E _{NO}	Output Noise	BW = 20Hz to 20KHz, flat Output Muted All gains = 0dB		2.5 5	15	μV μV
S/N	Signal to Noise Ratio	All gains 0dB; V _O = 1V _{RMS} ;		106		dB
d	Distortion	V _I = 1V _{RMS} ;		0.01	0.08	%
S _C	Channel Separation Left/Right		80	100		dB
E _T	Total Tracking Error	A _V = 0 to -20dB;		0	1	dB
		A _V = -20 to -60dB;		0	2	dB
BUS INPUT						
V _{IL}	Input Low Voltage				1	V
V _{IH}	Input High Voltage		3			V
I _{IN}	Input Current	V _{IN} = 0.4V	-5		5	μA
V _O	Output Voltage SDA Acknowledge	I _O = 1.6mA		0.4	0.8	V

(1) WIN represent the MUTE programming bit pair D6,D5 for the zero crossing window threshold

STEREO DECODER PART

ELECTRICAL CHARACTERISTICS ($V_S = 9V$; modulation frequency: 1KHz; de-emphasis time: $T = 50\mu s$; nominal MPX input voltage: $V_{MPX} = 0.5V_{RMS}$ (75KHz deviation); $G_I = 3.5dB$; $T_{amb} = 27^\circ C$; unless otherwise specified)

Symbol	Parameter	Test Condition	Min.	Typ.	Max.	Unit
V_{IN}	MPX Input Level			0.5	1.25	V_{RMS}
R_{IN}	Input Resistance		35	50	65	$K\Omega$
G_{MIN}	Minimum Input Gain		2.5	3.5	4.5	dB
G_{MAX}	Maximum Input Gain		9.5	11	12.5	dB
G_{STEP}	Step Resolution		1.75	2.5	3.25	dB
SVRR	Supply Voltage Ripple Rejection	$V_{RIPPLE} = 100mV$; $f = 1KHz$	50	60		dB
V_O	DC Output Voltage (HCL, HCR)		4.2	4.5	4.8	V
α	Channel Separation	$V_{SB} - V_R = 100mV_{DC}$		50		dB
THD	Total Harmonic distortion			0.02	0.2	%
$\frac{S+N}{N}$	Signal plus noise to noise ratio	$f = 200Hz$ to $16KHz$; $S = 2V_{RMS}$		91		dB
CARRIER AND HARMONIC SUPPRESSION AT THE OUTPUT						
α_{19}	Pilot Signal $f = 19KHz$		55	75		dB
α_{38}	Subcarrier $f = 38KHz$			75		dB
α_{57}	Subcarrier $f = 57KHz$			62		dB
α_{76}	Subcarrier $f = 76KHz$			90		dB
INTERMODULATION (note 1)						
α_2	$f_{mod} = 10KHz$; $f_{spur} = 1KHz$			65		dB
α_3	$f_{mod} = 13KHz$; $f_{spur} = 1KHz$			75		dB
TRAFFIC RADIO (note 2)						
α_{57}	Signal $f = 57KHz$			70		dB
SCA - SUBSIDIARY COMMUNICATIONS AUTHORIZATION (note 3)						
α_{67}	Signal $f = 67KHz$			75		dB
ACI - ADJACENT CHANNEL INTERFERENCE (note 4)						
α_{114}	Signal $f = 114KHz$			95		dB
α_{190}	Signal $f = 190KHz$			84		dB
MONO/STEREO SWITCH						
V_{INTH}	Pilot Threshold Voltage	for stereo "ON" $P_{th} = 1$ $P_{th} = 0$	11 18	15 25	22 34	mV_{RMS} mV_{RMS}
V_{INTH}	Pilot Threshold Voltage	for stereo "OFF" $P_{th} = 1$ $P_{th} = 0$	6 13	12 19	18 25	mV_{RMS} mV_{RMS}
STEREO BLEND						
V_{SB-VR}	Control Voltage for Channel Separation	$\alpha = 6dB$; $V_R = 3.6V$ (note 5)	-0.31	-0.26	-0.23	V
V_{SB-VR}	Control Voltage for Channel Separation	$\alpha = 26dB$;		-50		mV
HIGH CUT CONTROL						
τ_{deemp}	De-Emphasis Time Constant	$C_{13}, C_{14} = 1nF$; $V_{HCC-VR} = 100mV$		50		μs
R_{HCC}	High Cut Control Resistance	$V_{HCC-VR} = 100mV$		50		$K\Omega$
R_{HCC}	High Cut Control Resistance	$V_{HCC-VR} = -1.3V$ (note 6)	115	150	185	$K\Omega$
VCO						
f_{OSC}	Oscillator Frequency				456	
$\Delta f/f$	Capture and Holding Range				1	

TDA7340

ELECTRICAL CHARACTERISTICS (continued)

Symbol	Parameter	Test Condition	Min.	Typ.	Max.	Unit
NOISE INTERFERENCE DETECTOR						
V _{TR}	Trigger Threshold (1) (see pulse slope fig 3)	meas. with V _{RECT} = 1.2V	NTB = 00		100	mV _P
			NTB = 10		130	mV _P
			NTB = 11		170	mV _P
		meas. with V _{RECT} = 1.4V	NTB = 00		150	mV _P
			NTB = 10		200	mV _P
			NTB = 11		250	mV _P
V _{RECT}	Rectifier Voltage	V _{MPXIN} = 0mV	0.5	0.9	1.3	V
		V _{MPXIN} = 50mV; f = 150KHz		1.5		V
		V _{MPXIN} = 100mV; f = 150KHz	2.0	2.5	3.0	V
T _S	Suppression Pulse Duration	C _{BLANK} = 470pF		40		μs
I _{os}	Input Offset Current During Suppression Time			10		pA

(1) NTB represent the STDEC programming bit pair D₆, D₅ for the noise blanker trigger threshold

NOTES TO THE CHARACTERISTICS

1 INTERMODULATION SUPPRESSION

$$\alpha_2 = \frac{V_O \text{ (signal) (at1KHz)}}{V_O \text{ (spurious) (at1KHz)}} ; f_s = (2 \times 10\text{KHz}) - 19\text{KHz}$$

$$\alpha_3 = \frac{V_O \text{ (signal) (at1KHz)}}{V_O \text{ (spurious) (at1KHz)}} ; f_s = (3 \times 13\text{KHz}) - 38\text{KHz}$$

measured with : 91% mono signal; 9% pilot signal; f_m=10KHz or 13KHz

2. TRAFFIC RADIO (V.F.) suppression

$$\alpha_{57} \text{ (V.W.F.)} = \frac{V_O \text{ (signal) (at1KHz)}}{V_O \text{ (spurious) (at1KHz} \pm 23\text{Hz})}$$

measured with : 91% stereo signal; 9% pilot signal; f_m=1KHz; 5% subcarrier
(f=57KHz, f_m = 23Hz AM, m = 60%)

3. SCA (SUBSIDIARY COMMUNICATIONS AUTHORIZATION)

$$\alpha_{67} = \frac{V_O \text{ (signal) (at1KHz)}}{V_O \text{ (spurious) (at9KHz)}} ; f_s = (2 \times 38\text{KHz}) - 67\text{KHz}$$

measured with : 81% mono signal; 9% pilot signal; f_m=1KHz;
10% SCA - subcarrier (f_s = 67KHz, unmodulated)

4. ACI (ADJACENT CHANNEL INTERFERENCE)

$$\alpha_{114} = \frac{V_O \text{ (signal) (at1KHz)}}{V_O \text{ (spurious) (at4KHz)}} ; f_s = 110\text{KHz} - (3 \times 38\text{KHz})$$

$$\alpha_{190} = \frac{V_O \text{ (signal) (at1KHz)}}{V_O \text{ (spurious) (at4KHz)}} ; f_s = 186\text{KHz} - (5 \times 38\text{KHz})$$

measured with : 90% mono signal; 9% pilot signal; f_m=1KHz; 1% spurious signal
(f_s = 110KHz or 186KHz, unmodulated)

NOTES TO THE CHARACTERISTICS (continued)

- 5. Control range typ 11% of V_R (see figure 2)
- 6. Control range typ 30% of V_R (see figure 1)

Figure 1: High Cut Control

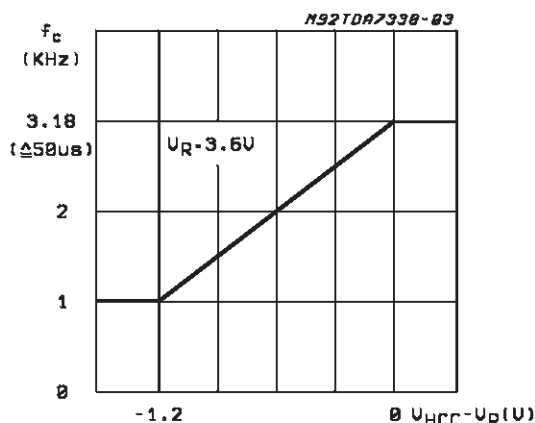

Figure 2: Stereo Blend

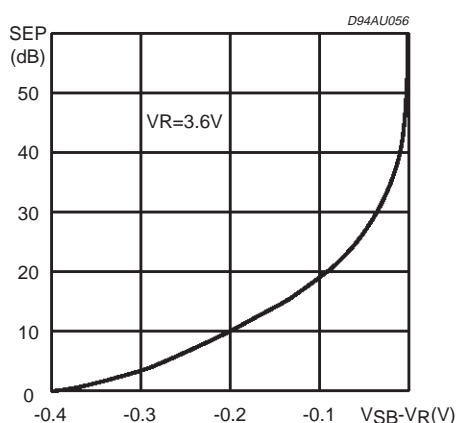
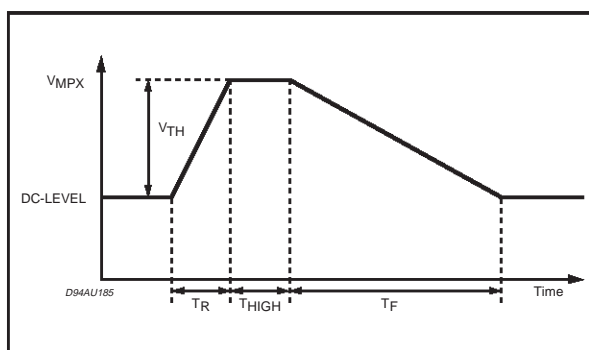

Figure 3



(*) All thresholds are measured by using a pulse with $T_R = 2\mu s$, $T_{HIGH} = 2\mu s$ and $T_F = 10\mu s$. The repetition rate must not increase the PEAK voltage.

I²C BUS INTERFACE
Interface Protocol

The interface protocol comprises:

- A start condition (S)
- A chip address byte, (the LSB bit determines read/write transmission).
- A subaddress byte
- A sequence of data (N-bytes + acknowledge)
- A stop condition (P)

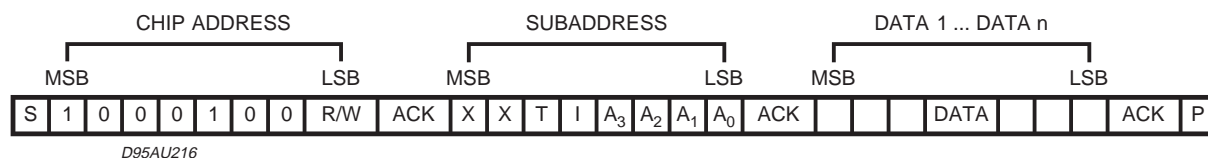

ACK = Acknowledge

S = Start

P = Stop

I = Autoincrement

MAX CLOCK SPEED 500kbits/s

Autoincrement

If bit I in the subaddress byte is set to "1", the autoincrement of subaddress is enabled.

TDA7340

SUBADDRESS (RECEIVE MODE)

MSB				LSB				FUNCTION
X	X	T	I	A ₃	A ₂	A ₁	A ₀	
				0	0	0	0	Input Selector
				0	0	0	1	Loudness
				0	0	1	0	Volume
				0	0	1	1	Bass, Treble
				0	1	0	0	Speaker Attenuator LF
				0	1	0	1	Speaker Attenuator LR
				0	1	1	0	Speaker Attenuator RF
				0	1	1	1	Speaker Attenuator RR
				1	0	0	0	Mute
				1	0	0	1	Stereodecoder

T = Testmode I = Autoincrement X = Not Used

TRANSMITTED DATA (SEND MODE)

MSB							LSB
X	X	X	X	ST	SM	ZM	\bar{P}

P = Pause (low active)

ZM = Zero Crossing Muted (HIGH = active)

SM = Soft mute activated (HIGH = active)

ST = Stereo (HIGH = active)

X = Not used

The transmitted data is automatically updated after each 9th clock pulse.

Transmission can be repeated without new chip address.

DATA BYTE SPECIFICATION

X = not relevant; set to "1" during testing

INPUT SELECTOR

MSB				LSB				FUNCTION
D7	D6	D5	D4	D3	D2	D1	D0	
0					0	0	0	Quasi Diff CD
1					0	0	0	Full Diff CD
					0	0	1	Stereo Decoder
					0	1	0	Cassette Stereo
		1			0	1	1	AM Mono
					1	0	0	Telephone Mono
		1			1	0	1	Beep Mono
		0			0	1	1	AM Stereo
		0			1	0	1	Not allowed
					1	1	0	Not allowed
					1	1	1	Not allowed
			0	0				11.25dB gain
			0	1				7.5dB Gain
			1	0				3.75dB Gain
			1	1				0 dB Gain
	0							0dB Differential input Gain (CD Input)
	1							-6dB Differential input Gain (CD Input)

For example to select quasi diff CD input with 0dB diff gain and 7.5dB input gain the Data Byte is: 00001000

LOUDNESS

MSB				LSB				LOUDNESS
D7	D6	D5	D4	D3	D2	D1	D0	
X	X	X	0	0	0	0	0	0dB
X	X	X	0	0	0	0	1	-1.25dB
X	X	X	0	0	0	1	0	-2.5dB
X	X	X	0	0	0	1	1	-3.75dB
X	X	X	0	0	1	0	0	-5dB
X	X	X	0	0	1	0	1	-6.25dB
X	X	X	0	0	1	1	0	-7.5dB
X	X	X	0	0	1	1	1	-8.75dB
X	X	X	0	1	0	0	0	-10dB
X	X	X	0	1	0	0	1	-11.25dB
X	X	X	0	1	0	1	0	-12.5dB
X	X	X	0	1	0	1	1	-13.75dB
X	X	X	0	1	1	0	0	-15dB
X	X	X	0	1	1	0	1	-16.25dB
X	X	X	0	1	1	1	0	-17.5dB
X	X	X	0	1	1	1	1	-18.75dB
X	X	X	1	D ₃	D ₂	D ₁	D ₀	loudness OFF (1)

For example to select -17.5dB loudness the Data Byte is: XXX01110

Note (1):

If the loudness is switched OFF, the loudness stage is acting like a volume attenuator with flat frequency response. D0 to D3 determine the attenuation level.

MUTE

MSB				LSB				FUNCTION
D7	D6	D5	D4	D3	D2	D1	D0	
							1	Soft Mute On
							0	Soft Mute with fast slope (I = I _{MAX})
							1	Soft Mute with slow slope (I = I _{MIN})
				1				Direct Mute
			0		1			Zero Crossing Mute ON
			0		0			ZC Mute OFF (delayed until next zero crossing)
			1					Zero Crossing Mute and Pause Detector Reset
	0	0						160mV ZC Window Threshold (WIN = 00)
	0	1						80mV ZC Window Threshold (WIN = 01)
	1	0						40mV ZC Window Threshold (WIN = 10)
	1	1						20mV ZC Window Threshold (WIN = 11)
0								Nonsymmetrical Bass Cut
1								Symmetrical Bass Cut

An additional direct mute function is included in the Speaker Attenuators

TDA7340

SPEAKER ATTENUATORS

MSB							LSB	SPEAKER ATTENUATORS LF, LR, RF, RR
D7	D6	D5	D4	D3	D2	D1	D0	
								-1.25dB STEPS
1	1	1			0	0	0	0dB
1	1	1			0	0	1	-1.25dB
1	1	1			0	1	0	-2.5dB
1	1	1			0	1	1	-3.75dB
1	1	1			1	0	0	-5dB
1	1	1			1	0	1	-6.25dB
1	1	1			1	1	0	-7.5dB
1	1	1			1	1	1	-8.75dB
								10dB STEPS
1	1	1	0	0				0dB
1	1	1	0	1				-10dB
1	1	1	1	0				-20dB
1	1	1	1	1				-30dB
1	1	1	1	1	1	1	1	Speaker Mute

For example an attenuation of 25dB on a selected output is given by: 11110100

STEREO DECODER

MSB							LSB	FUNCTION
D7	D6	D5	D4	D3	D2	D1	D0	
						0	0	11dB Input Gain
						0	1	8.5dB Input Gain
						1	0	6dB Input Gain
						1	1	3.5dB Input Gain
					1			Stereo Decoder Muted
				1				Stereo Decoder Off
			1					Forced Mono
	0	0						Noise Blanker Threshold 1 (NTB = 00)
	1	0						Noise Blanker Threshold 2 (NTB = 10)
	1	1						Noise Blanker Threshold 3 (NTB = 11)
0								Pilot Threshold High ($P_{th} = 0$)
1								Pilot Threshold Low ($P_{th} = 1$)

For example pilot threshold low, noise blanker threshold 2 (NTB = 10), Stereo decoder ON, 6dB input gain is given by: 11000010.

BASS/TREBLE

MSB				LSB				FUNCTION
D7	D6	D5	D4	D3	D2	D1	D0	
								TREBLE STEPS
				0	0	0	0	-14dB
				0	0	0	1	-12dB
				0	0	1	0	-10dB
				0	0	1	1	-8dB
				0	1	0	0	-6dB
				0	1	0	1	-4dB
				0	1	1	0	-2dB
				0	1	1	1	0dB
				1	1	1	1	0dB
				1	1	1	0	2dB
				1	1	0	1	4dB
				1	1	0	0	6dB
				1	0	1	1	8dB
				1	0	1	0	10dB
				1	0	0	1	12dB
				1	0	0	0	14dB
								BASS STEPS
0	0	0	0					-14dB
0	0	0	1					-12dB
0	0	1	0					-10dB
0	0	1	1					-8dB
0	1	0	0					-6dB
0	1	0	1					-4dB
0	1	1	0					-2dB
0	1	1	1					0dB
1	1	1	1					0dB
1	1	1	0					2dB
1	1	0	1					4dB
1	1	0	0					6dB
1	0	1	1					8dB
1	0	1	0					10dB
1	0	0	1					12dB
1	0	0	0					14dB

For example 12dB TREBLE and -8dB BASS give the following Data Byte : 00111001

TDA7340

VOLUME

MSB				LSB				FUNCTION
D7	D6	D5	D4	D3	D2	D1	D0	
								0.31dB FINE ATTENUATION STEPS
						0	0	0
						0	1	-0.31dB
						1	0	-0.62dB
						1	1	-0.94dB
								1.25dB COARSE ATTENUATION STEPS
			0	0	0			0dB
			0	0	1			-1.25dB
			0	1	0			-2.5dB
			0	1	1			-3.75dB
			1	0	0			-5dB
			1	0	1			-6.25dB
			1	1	0			-7.5dB
			1	1	1			-8.75dB
								10dB GAIN ATTENUATION STEPS
0	0	0						20dB
0	0	1						10dB
0	1	0						0dB
0	1	1						-10dB
1	0	0						-20dB
1	0	1						-30dB
1	1	0						-40dB
1	1	1						-50dB

For example to select -47.81dB Volume the Data Byte is: 11011001

STATUS AFTER POWER ON RESET

VOLUME	-59.69dB
BASS, TREBLE	Treble = +2dB, Bass = 0dB, symmetrical
SPKRS LF, RF, LR, RR	-37.5dB
LOUDNESS	OFF, -17.5dB
INPUT	No input selected, GAIN = 0dB, DIFF CD GAIN = -06dB, FULLY DIFF MODE
STEREODEC	OFF, FORCED MONO, 6dB GAIN, PILOT THRESHOLD LOW, NOISE BLANKER =11
MUTE	DIRECTLY MUTED, SOFT OFF, ZEROCROSS RESET, WINDOW THRESHOLD =11

DIM.	mm			inch		
	MIN.	TYP.	MAX.	MIN.	TYP.	MAX.
A			2.45			0.096
A1	0.25			0.010		
A2	1.95	2.00	2.10	0.077	0.079	0.083
B	0.30		0.45	0.012		0.018
c	0.13		0.23	0.005		0.009
D	12.95	13.20	13.45	0.51	0.52	0.53
D1	9.90	10.00	10.10	0.390	0.394	0.398
D3		8.00			0.315	
e		0.80			0.031	
E	12.95	13.20	13.45	0.510	0.520	0.530
E1	9.90	10.00	10.10	0.390	0.394	0.398
E3		8.00			0.315	
L	0.65	0.80	0.95	0.026	0.031	0.037
L1		1.60			0.063	
K	0°(min.), 7°(max.)					

OUTLINE AND MECHANICAL DATA

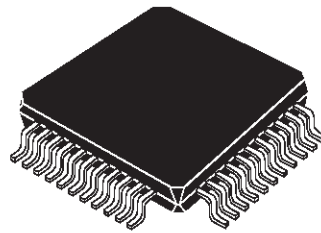

PQFP44 (10 x 10)

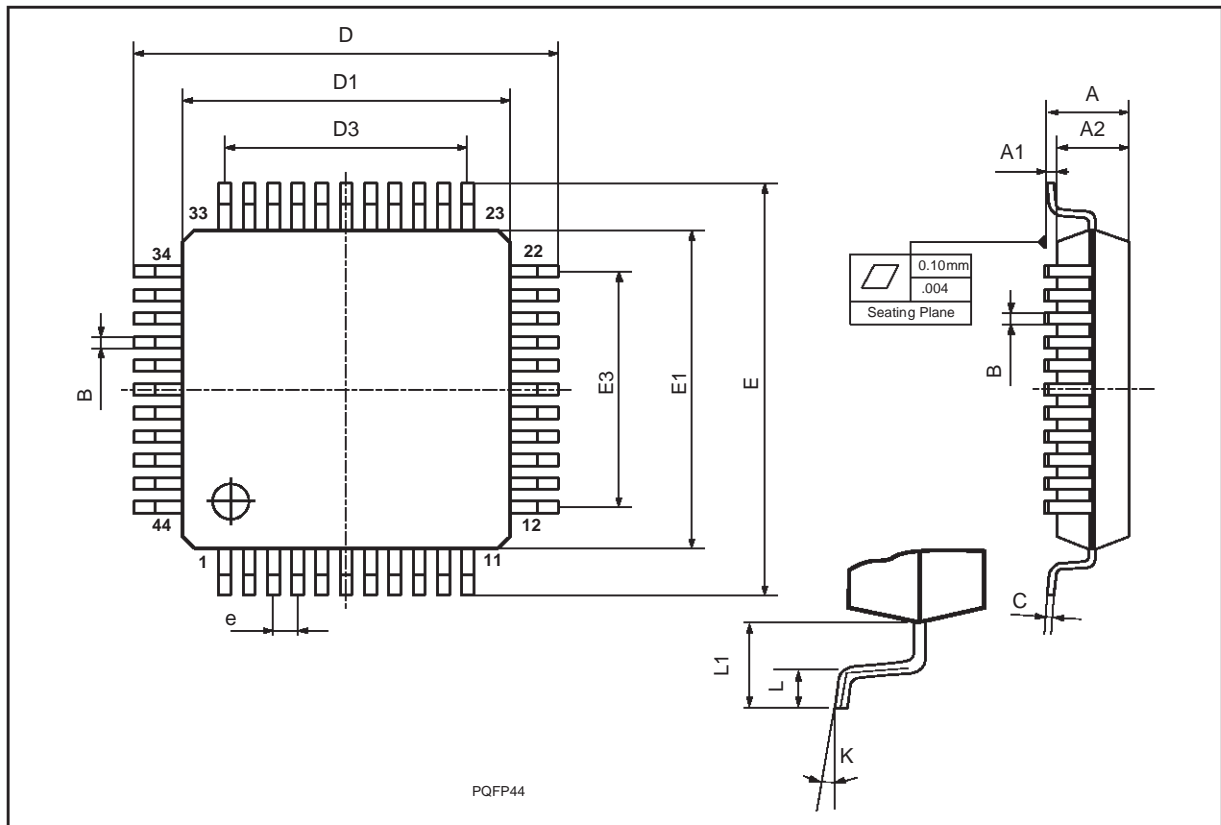

Information furnished is believed to be accurate and reliable. However, STMicroelectronics assumes no responsibility for the consequences of use of such information nor for any infringement of patents or other rights of third parties which may result from its use. No license is granted by implication or otherwise under any patent or patent rights of STMicroelectronics. Specification mentioned in this publication are subject to change without notice. This publication supersedes and replaces all information previously supplied. STMicroelectronics products are not authorized for use as critical components in life support devices or systems without express written approval of STMicroelectronics.

The ST logo is a registered trademark of STMicroelectronics

© 1999 STMicroelectronics – Printed in Italy – All Rights Reserved

STMicroelectronics GROUP OF COMPANIES

Australia - Brazil - China - Finland - France - Germany - Hong Kong - India - Italy - Japan - Malaysia - Malta - Morocco -
Singapore - Spain - Sweden - Switzerland - United Kingdom - U.S.A.

<http://www.st.com>