



16-BIT, ULTRA-LOW GLITCH, VOLTAGE OUTPUT DIGITAL-TO-ANALOG CONVERTER

FEATURES

- **16-Bit Monotonic Over Temperature**
- **Relative Accuracy: 8 LSB (Max)**
- **Glitch Energy: 0.1 nV-s**
- **Settling Time: 10 μ s to $\pm 0.003\%$ FSR**
- **Power Supply: +2.7 V to +5.5 V**
- **MicroPower Operation: 200 μ A at 5 V**
- **Rail-to-Rail Output Amplifier**
- **Power-On Reset to Zero**
- **Power-Down Capability**
- **Schmitt-Triggered Digital Inputs**
- **SYNC Interrupt Facility**
- **Drop-In Compatible With DAC8531/01**
- **Operating Temperature Range: -40°C to 105°C**
- **Available Package:**
 - 3 mm \times 5 mm MSOP-8

APPLICATIONS

- **Process Control**
- **Data Acquisition Systems**
- **Closed-Loop Servo-Control**
- **PC Peripherals**
- **Portable Instrumentation**
- **Programmable Attenuation**

DESCRIPTION

The DAC8551 is a small, low-power, voltage output, 16-bit digital-to-analog converter (DAC). It is monotonic, provides good linearity, and minimizes undesired code-to-code transient voltages. The DAC8551 uses a versatile 3-wire serial interface that operates at clock rates to 30 MHz and is compatible with standard SPI™, QSPI™, Microwire™, and digital signal processor (DSP) interfaces.

The DAC8551 requires an external reference voltage to set its output range. The DAC8551 incorporates a power-on-reset circuit that ensures the DAC output powers up at 0 V and remains there until a valid write takes place to the device. The DAC8551 contains a power-down feature, accessed over the serial interface, that reduces the current consumption of the device to 200 nA at 5 V.

The low-power consumption of this device in normal operation makes it ideally suited for portable battery-operated equipment. The power consumption is 1.00 mW at 5 V, reducing to 1 μ W in power-down mode.

The DAC8551 is available in an MSOP-8 package.

FUNCTIONAL BLOCK DIAGRAM

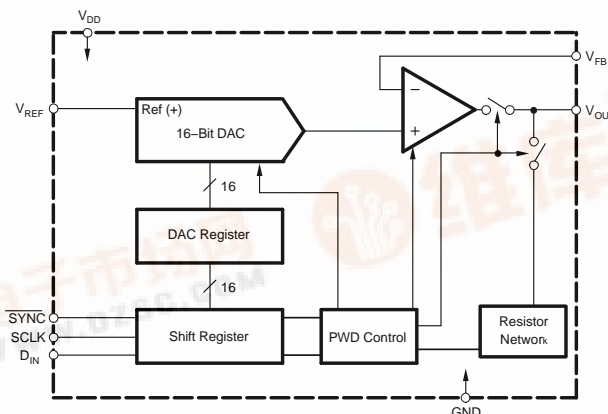

Please be aware that an important notice concerning availability, standard warranty, and use in critical applications of Texas Instruments semiconductor products and disclaimers thereto appears at the end of this data sheet.

SPI, QSPI are trademarks of Motorola.

Microwire is a trademark of National Semiconductor.



This integrated circuit can be damaged by ESD. Texas Instruments recommends that all integrated circuits be handled with appropriate precautions. Failure to observe proper handling and installation procedures can cause damage.

ESD damage can range from subtle performance degradation to complete device failure. Precision integrated circuits may be more susceptible to damage because very small parametric changes could cause the device not to meet its published specifications.

PACKAGING/ORDERING INFORMATION

PRODUCT	MINIMUM RELATIVE ACCURACY (LSB)	DIFFERENTIAL NONLINEARITY (LSB)	PACKAGE LEAD	PACKAGE DESIGNATOR ⁽¹⁾	SPECIFICATION TEMPERATURE RANGE	PACKAGE MARKING	ORDERING NUMBER	TRANSPORT MEDIA, QUANTITY
DAC8551I	±8	±1	MSOP-8	DGK	-40°C TO 105°C	D81	DAC8551IDGK	Tube, 80
							DAC8551IDGKT	Tape and Reel, 250
							DAC8551IDGKR	Tape and Reel, 2500

(1) For the most current specifications and package information, refer to our web site at www.ti.com.

ABSOLUTE MAXIMUM RATINGS⁽¹⁾

	UNIT	
V _{DD} to GND	-0.3 V to 6 V	
Digital input voltage to GND	-0.3 V to +V _{DD} + 0.3 V	
V _{OUT} to GND	-0.3 V to +V _{DD} + 0.3 V	
Operating temperature range	-40°C to 105°C	
Storage temperature range	-65°C to 150°C	
Junction temperature range (T _J max)	150°C	
Power dissipation (DGK)	(T _J max - T _A)/θ _{JA}	
θ _{JA} Thermal impedance	206°C/W	
θ _{JC} Thermal impedance	44°C/W	
Lead temperature, soldering	Vapor phase (60 s)	215°C
	Infrared (15 s)	220°C

(1) Stresses above those listed under *absolute maximum ratings* may cause permanent damage to the device. Exposure to absolute maximum conditions for extended periods may affect device reliability.

ELECTRICAL CHARACTERISTICS

V_{DD} = 2.7 V to 5.5 V, - 40°C to 105°C range (unless otherwise noted)

PARAMETER	TEST CONDITIONS	MIN	TYP	MAX	UNIT
STATIC PERFORMANCE⁽¹⁾					
Resolution		16			Bits
Relative accuracy	Measured by line passing through codes 485 and 64741		±3	±8	LSB
Differential nonlinearity	16-bit Monotonic		±0.25	±1	LSB
Zero-code error	Measured by line passing through codes 485 and 64741.		±2	±12	mV
Full-scale error			±0.05	±0.5	% of FSR
Gain error			±0.02	±0.15	% of FSR
Zero-code error drift			±5		µV/°C
Gain temperature coefficient			±1		ppm of FSR/°C
Power supply rejection ratio (PSRR)	R _L = 2 kΩ, C _L = 200 pF		8		mV
				0.75	mV/V

(1) Linearity calculated using a reduced code range of 485 to 64741; output unloaded.

ELECTRICAL CHARACTERISTICS (continued)
 $V_{DD} = 2.7\text{ V to }5.5\text{ V}$, $-40^{\circ}\text{C to }105^{\circ}\text{C}$ range (unless otherwise noted)

PARAMETER	TEST CONDITIONS	MIN	TYP	MAX	UNIT
OUTPUT CHARACTERISTICS⁽²⁾					
Output voltage range		0		V_{REF}	V
Output voltage settling time	$T_o \pm 0.003\%$ FSR, 0200 _H to FD00 _H , $R_L = 2\text{ k}\Omega$, $0\text{ pF} < C_L < 200\text{ pF}$		8	10	μs
	$R_L = 2\text{ k}\Omega$, $C_L = 500\text{ pF}$		12		μs
Slew rate			1.8		V/ μs
Capacitive load stability	$R_L = \infty$		470		pF
	$R_L = 2\text{ k}\Omega$		1000		pF
Code change glitch impulse	1 LSB change around major carry		0.1		nV-s
Digital feedthrough	SCLK toggling, FSYNC high		0.1		
DC output impedance	At mid-code input		1		Ω
Short-circuit current	$V_{DD} = 5\text{ V}$		50		mA
	$V_{DD} = 3\text{ V}$		20		
Power-up time	Coming out of power-down mode $V_{DD} = 5\text{ V}$		2.5		μs
	Coming out of power-down mode $V_{DD} = 3\text{ V}$		5		
AC PERFORMANCE					
SNR (1st 19 harmonics removed)	BW = 20 kHz, $V_{DD} = 5\text{ V}$, $F_{OUT} = 1\text{ kHz}$		95		dB
THD			85		
SFDR			87		
SINAD			84		
REFERENCE INPUT					
V_{REF} Voltage		0		V_{DD}	V
Reference input range	$V_{REF} = V_{DD} = 5\text{ V}$		50	75	μA
	$V_{REF} = V_{DD} = 3.6\text{ V}$		30	45	μA
Reference input impedance			125		k Ω
LOGIC INPUTS⁽³⁾					
Input current			± 1		μA
V_{INL} Logic input LOW voltage	$V_{DD} = 5\text{ V}$			0.8	V
	$V_{DD} = 3\text{ V}$			0.6	
V_{INH} Logic input HIGH voltage	$V_{DD} = 5\text{ V}$	2.4			V
	$V_{DD} = 3\text{ V}$	2.1			
Pin capacitance				3	pF
POWER REQUIREMENTS					
V_{DD}		2.7		5.5	V
I_{DD} (normal mode)	Input code = 32768, reference current included, no load				
$V_{DD} = 3.6\text{ V to }5.5\text{ V}$	$V_{IH} = V_{DD}$ and $V_{IL} = \text{GND}$		200	250	μA
$V_{DD} = 2.7\text{ V to }3.6\text{ V}$			180	240	
I_{DD} (all power-down modes)					
$V_{DD} = 3.6\text{ V to }5.5\text{ V}$	$V_{IH} = V_{DD}$ and $V_{IL} = \text{GND}$		0.2	1	μA
$V_{DD} = 2.7\text{ V to }3.6\text{ V}$			0.05	1	
POWER EFFICIENCY					
I_{OUT}/I_{DD}	$I_{LOAD} = 2\text{ mA}$, $V_{DD} = 5\text{ V}$		89%		
TEMPERATURE RANGE					
Specified performance		-40		105	$^{\circ}\text{C}$

(2) Ensured by design and characterization, not production tested.

(3) Ensured by design and characterization, not production tested.

PIN CONFIGURATION

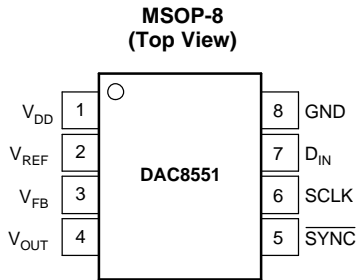

PIN DESCRIPTIONS

PIN	NAME	DESCRIPTION
1	V _{DD}	Power supply input, 2.7 V to 5.5 V.
2	V _{REF}	Reference voltage input.
3	V _{FB}	Feedback connection for the output amplifier. For voltage output operation, tie to V _{OUT} externally.
4	V _{OUT}	Analog output voltage from DAC. The output amplifier has rail-to-rail operation.
5	$\overline{\text{SYNC}}$	Level-triggered control input (active LOW). This is the frame synchronization signal for the input data. When $\overline{\text{SYNC}}$ goes LOW, it enables the input shift register and data is transferred in on the falling edges of the following clocks. The DAC is updated following the 24th clock (unless $\overline{\text{SYNC}}$ is taken HIGH before this edge in which case the rising edge of $\overline{\text{SYNC}}$ acts as an interrupt and the write sequence is ignored by the DAC8551).
6	SCLK	Serial clock input. Data can be transferred at rates up to 30 MHz.
7	D _{IN}	Serial data input. Data is clocked into the 24-bit input shift register on each falling edge of the serial clock input.
8	GND	Ground reference point for all circuitry on the part.

TIMING REQUIREMENTS⁽¹⁾⁽²⁾

$V_{DD} = 2.7\text{ V to }5.5\text{ V}$, all specifications $-40^{\circ}\text{C to }105^{\circ}\text{C}$ (unless otherwise noted)

PARAMETER	TEST CONDITIONS	MIN	TYP	MAX	UNIT
$t_1^{(3)}$ SCLK cycle time	$V_{DD} = 2.7\text{ V to }3.6\text{ V}$	50			ns
	$V_{DD} = 3.6\text{ V to }5.5\text{ V}$	33			
t_2 SCLK HIGH time	$V_{DD} = 2.7\text{ V to }3.6\text{ V}$	13			ns
	$V_{DD} = 3.6\text{ V to }5.5\text{ V}$	13			
t_3 SCLK LOW time	$V_{DD} = 2.7\text{ V to }3.6\text{ V}$	22.5			ns
	$V_{DD} = 3.6\text{ V to }5.5\text{ V}$	13			
t_4 $\overline{\text{SYNC}}$ to SCLK rising edge setup time	$V_{DD} = 2.7\text{ V to }3.6\text{ V}$	0			ns
	$V_{DD} = 3.6\text{ V to }5.5\text{ V}$	0			
t_5 Data setup time	$V_{DD} = 2.7\text{ V to }3.6\text{ V}$	5			ns
	$V_{DD} = 3.6\text{ V to }5.5\text{ V}$	5			
t_6 Data hold time	$V_{DD} = 2.7\text{ V to }3.6\text{ V}$	4.5			ns
	$V_{DD} = 3.6\text{ V to }5.5\text{ V}$	4.5			
t_7 SCLK falling edge to $\overline{\text{SYNC}}$ rising edge	$V_{DD} = 2.7\text{ V to }3.6\text{ V}$	0			ns
	$V_{DD} = 3.6\text{ V to }5.5\text{ V}$	0			
t_8 Minimum $\overline{\text{SYNC}}$ HIGH time	$V_{DD} = 2.7\text{ V to }3.6\text{ V}$	50			ns
	$V_{DD} = 3.6\text{ V to }5.5\text{ V}$	33			

(1) All input signals are specified with $t_R = t_F = 3\text{ ns}$ (10% to 90% of V_{DD}) and timed from a voltage level of $(V_{IL} + V_{IH})/2$.

(2) See Serial Write Operation timing diagram.

(3) Maximum SCLK frequency is 30 MHz at $V_{DD} = 3.6\text{ V to }5.5\text{ V}$ and 20 MHz at $V_{DD} = 2.7\text{ V to }3.6\text{ V}$.

SERIAL WRITE OPERATION

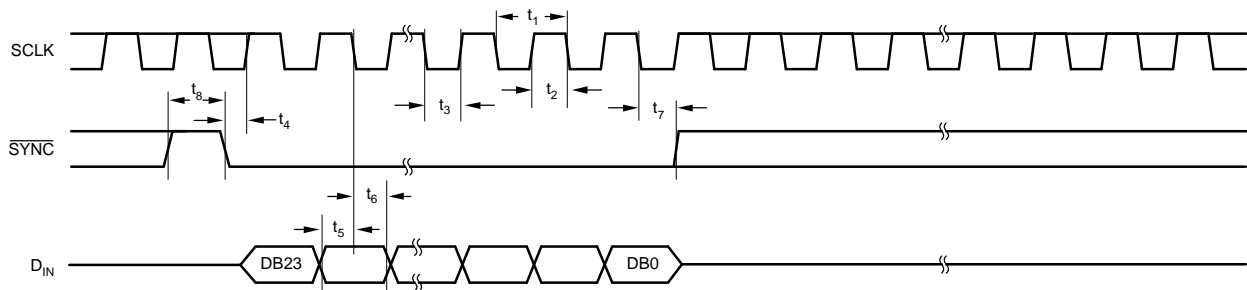

TYPICAL CHARACTERISTICS: $V_{DD} = 5\text{ V}$

At $T_A = 25^\circ\text{C}$, unless otherwise noted

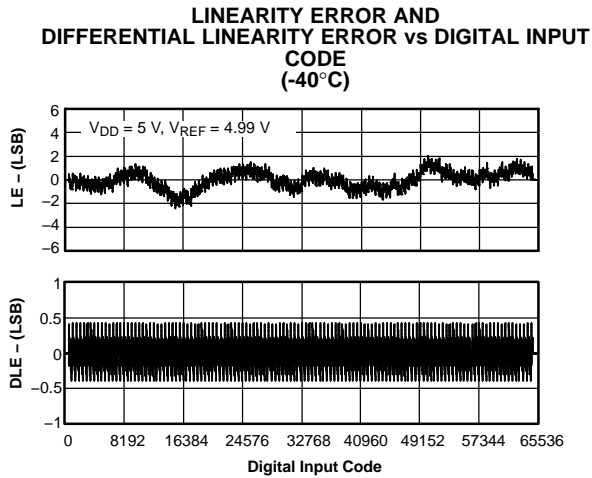

Figure 1.

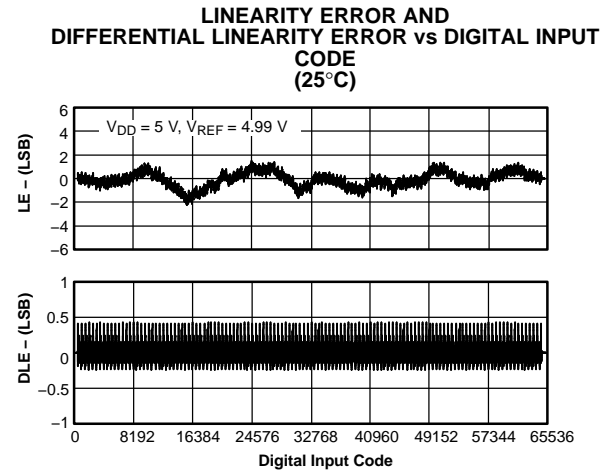

Figure 2.

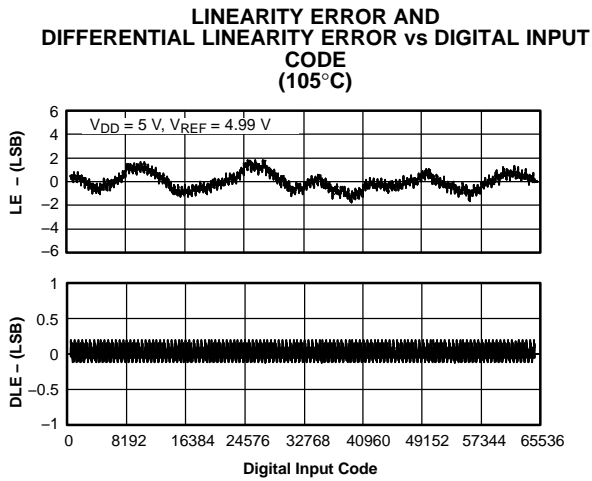

Figure 3.

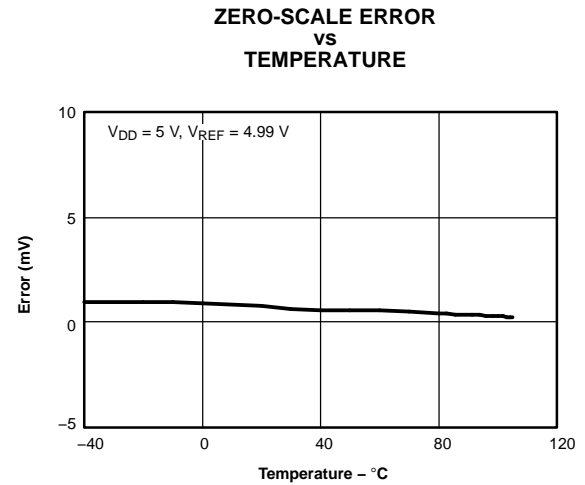

Figure 4.

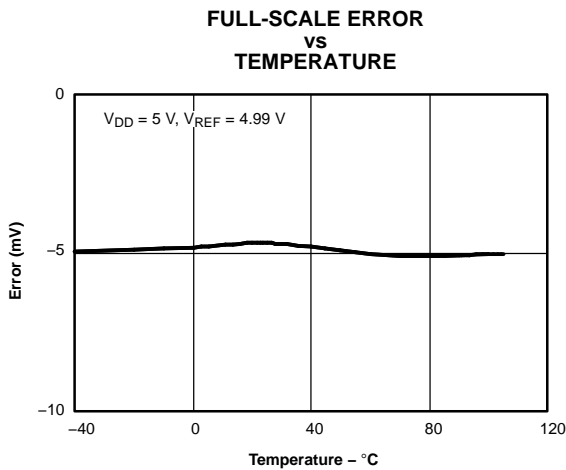

Figure 5.

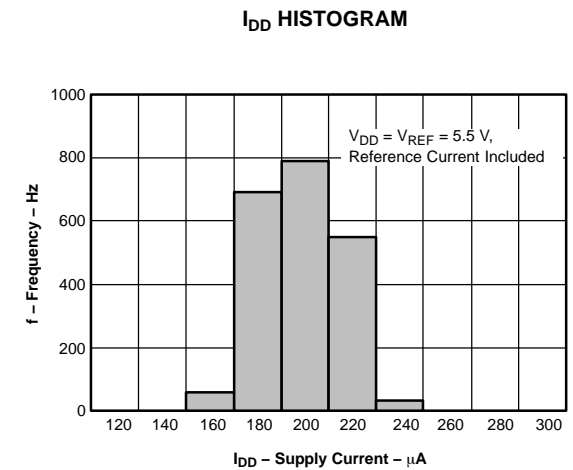

Figure 6.

TYPICAL CHARACTERISTICS: $V_{DD} = 5\text{ V}$ (continued)

At $T_A = 25^\circ\text{C}$, unless otherwise noted

SOURCE AND SINK CURRENT CAPABILITY

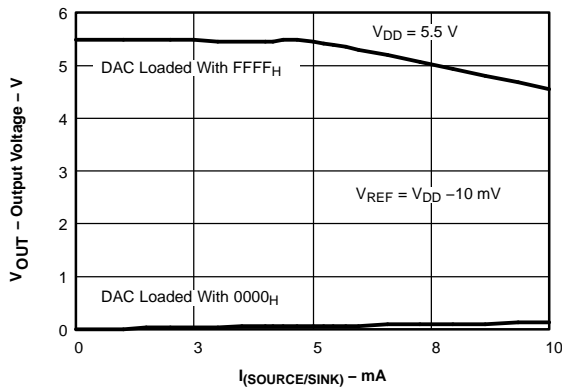

Figure 7.

**SUPPLY CURRENT
VS
DIGITAL INPUT CODE**

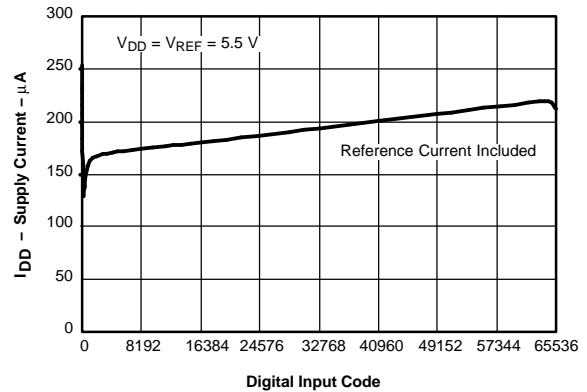

Figure 8.

**POWER-SUPPLY CURRENT
VS
TEMPERATURE**

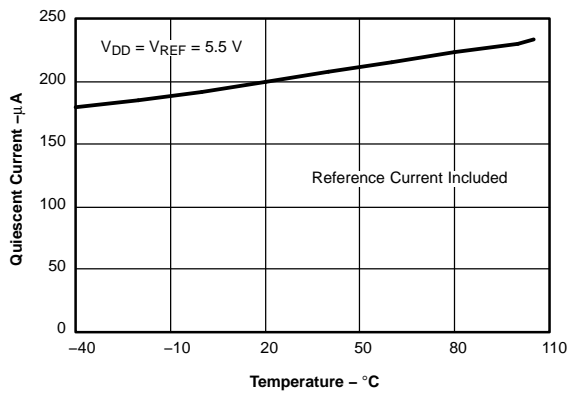

Figure 9.

**SUPPLY CURRENT
VS
SUPPLY VOLTAGE**

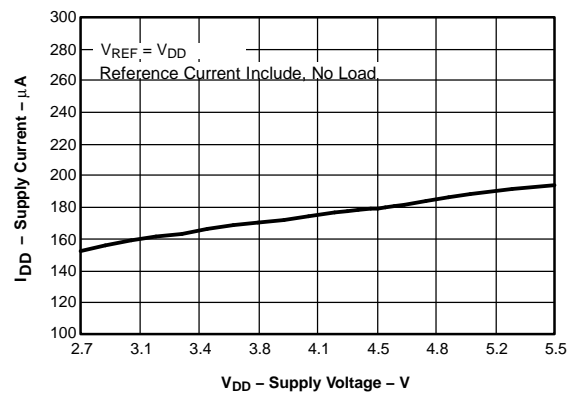

Figure 10.

**POWER-DOWN CURRENT
VS
SUPPLY VOLTAGE**

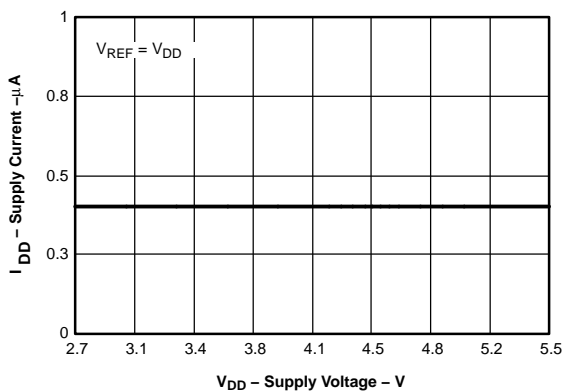

Figure 11.

**SUPPLY CURRENT
VS
LOGIC INPUT VOLTAGE**

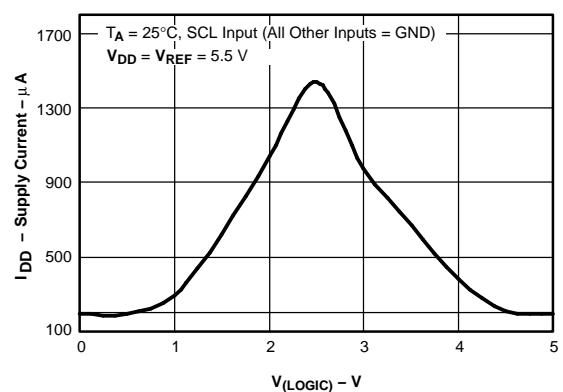

Figure 12.

SLAS429A—APRIL 2005—REVISED JULY 2005

TYPICAL CHARACTERISTICS: $V_{DD} = 5\text{ V}$ (continued)

At $T_A = 25^\circ\text{C}$, unless otherwise noted

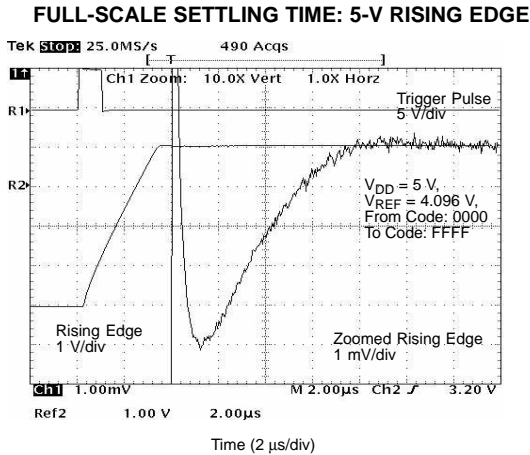

Figure 13.

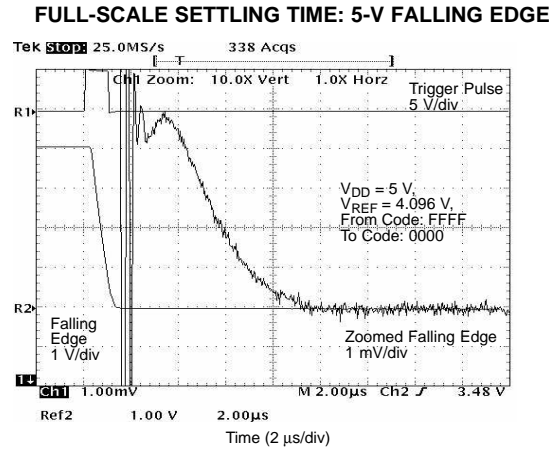

Figure 14.

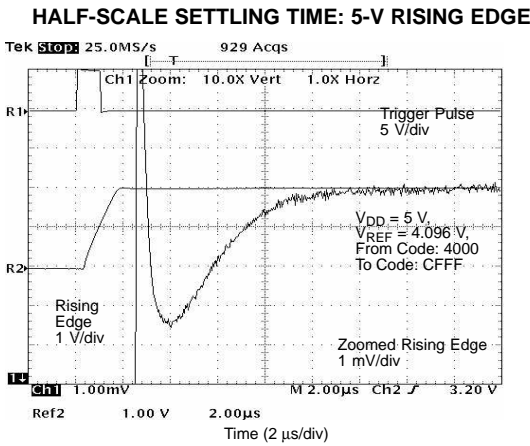

Figure 15.

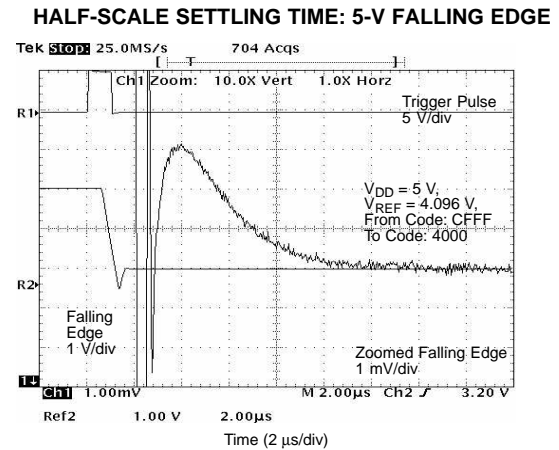

Figure 16.

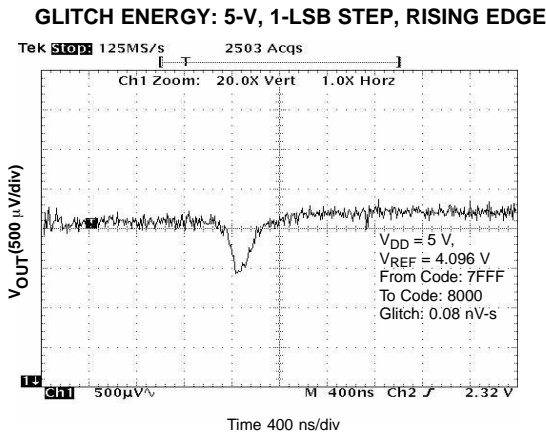

Figure 17.

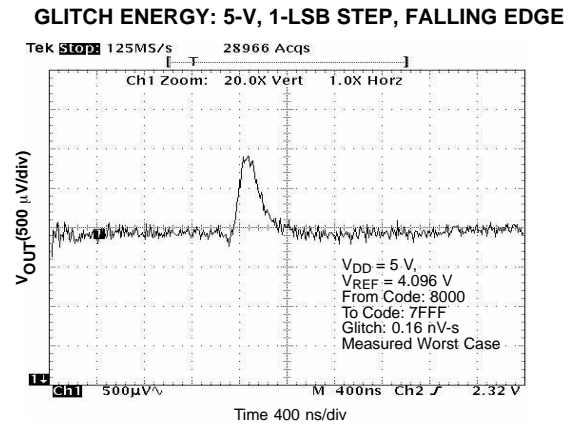

Figure 18.

TYPICAL CHARACTERISTICS: $V_{DD} = 5\text{ V}$ (continued)

At $T_A = 25^\circ\text{C}$, unless otherwise noted

GLITCH ENERGY: 5-V, 16-LSB STEP, RISING EDGE

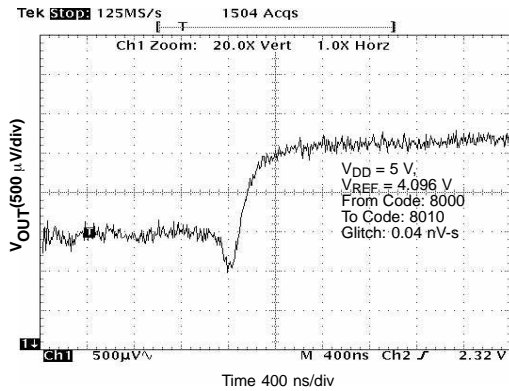

Figure 19.

GLITCH ENERGY: 5-V, 16-LSB STEP, FALLING EDGE

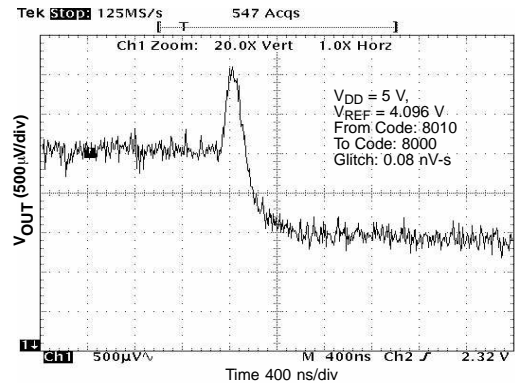

Figure 20.

GLITCH ENERGY: 5-V, 256-LSB STEP, RISING EDGE

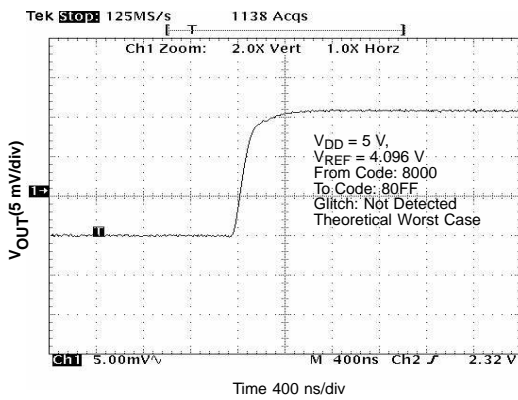

Figure 21.

GLITCH ENERGY: 5-V, 256-LSB STEP, FALLING EDGE

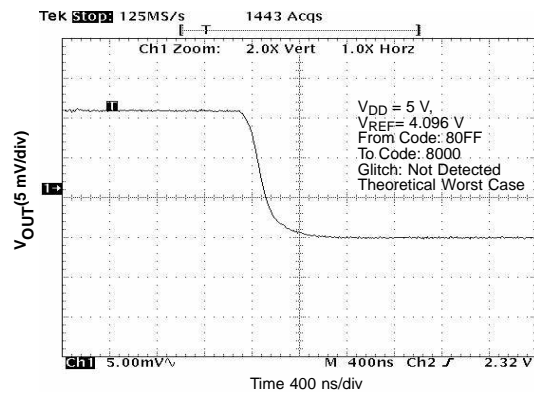

Figure 22.

TOTAL HARMONIC DISTORTION VS OUTPUT FREQUENCY

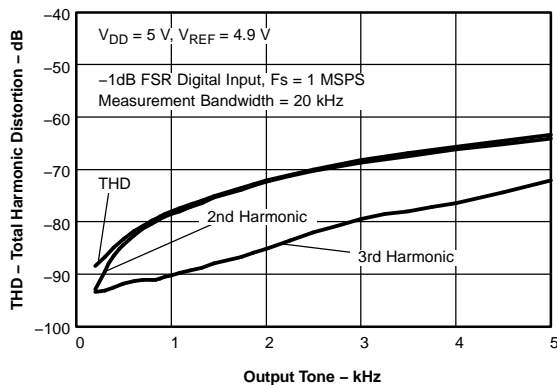

Figure 23.

SIGNAL-TO-NOISE RATIO VS OUTPUT FREQUENCY

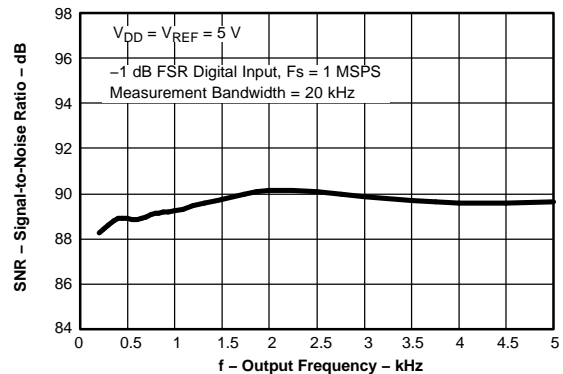

Figure 24.

TYPICAL CHARACTERISTICS: $V_{DD} = 5\text{ V}$ (continued)

At $T_A = 25^\circ\text{C}$, unless otherwise noted

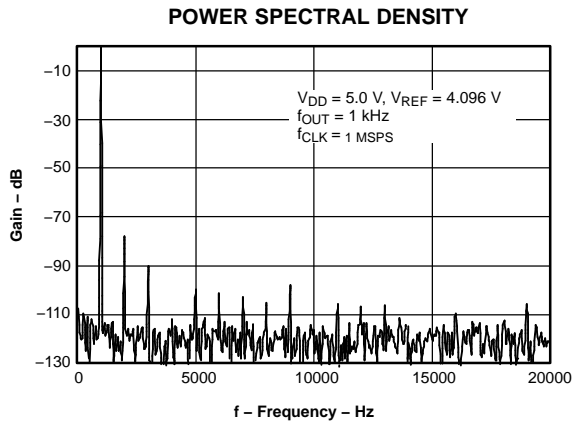

Figure 25.

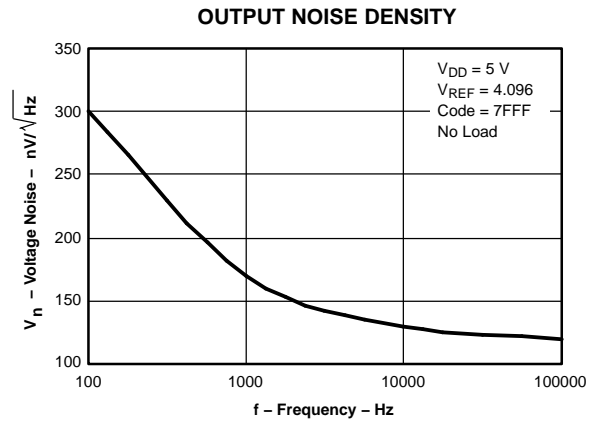

Figure 26.

TYPICAL CHARACTERISTICS: $V_{DD} = 2.7\text{ V}$

At $T_A = 25^\circ\text{C}$, unless otherwise noted

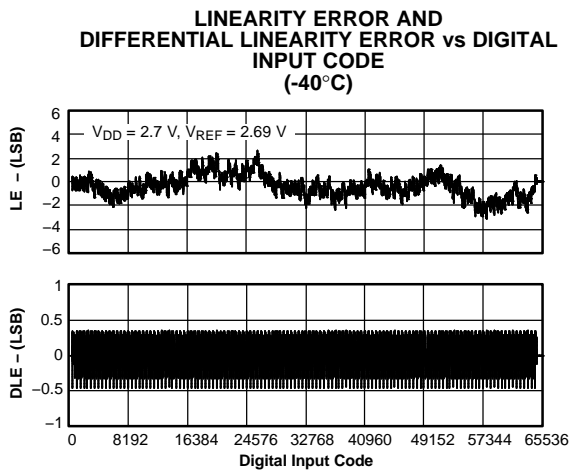

Figure 27.

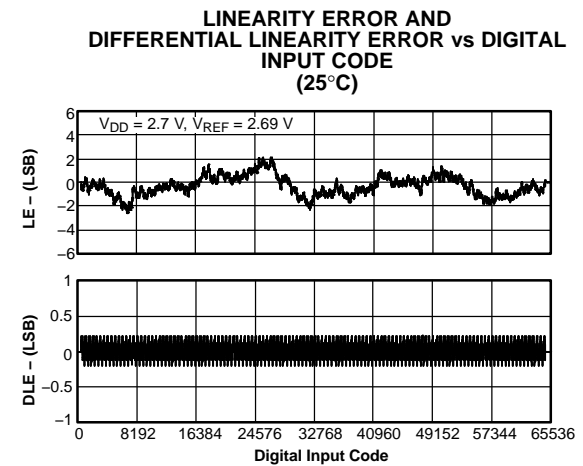

Figure 28.

TYPICAL CHARACTERISTICS: $V_{DD} = 2.7\text{ V}$ (continued)

At $T_A = 25^\circ\text{C}$, unless otherwise noted

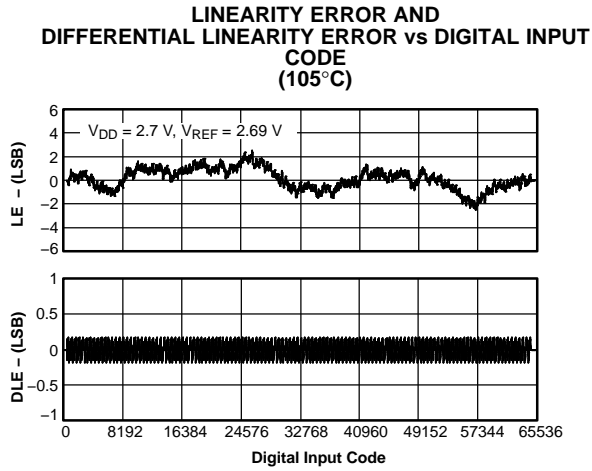

Figure 29.

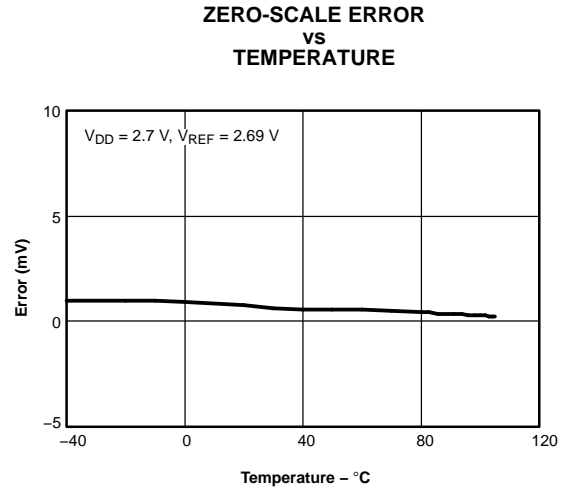

Figure 30.

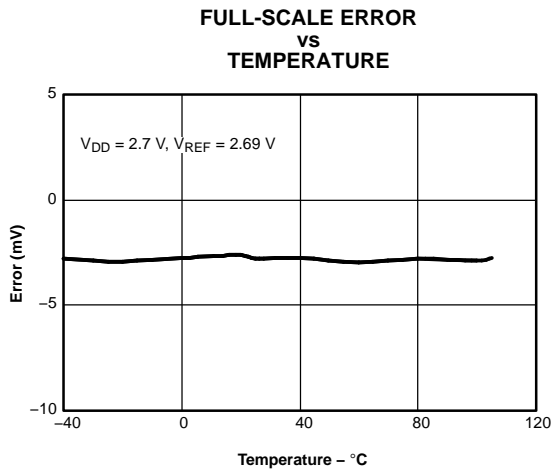

Figure 31.

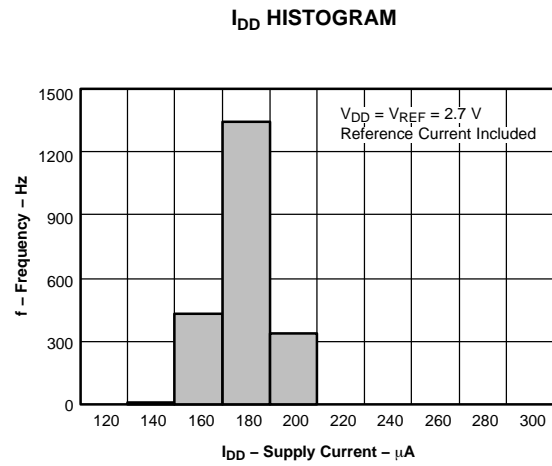

Figure 32.

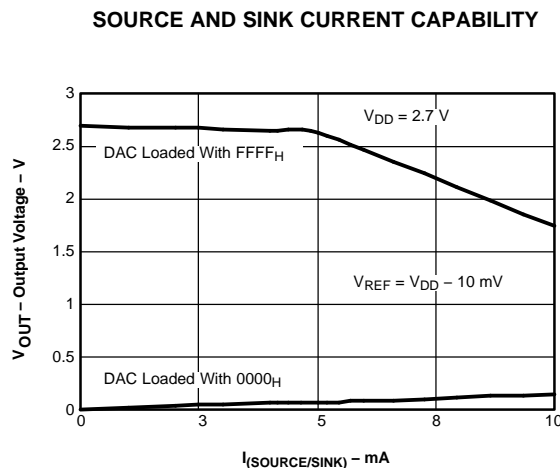

Figure 33.

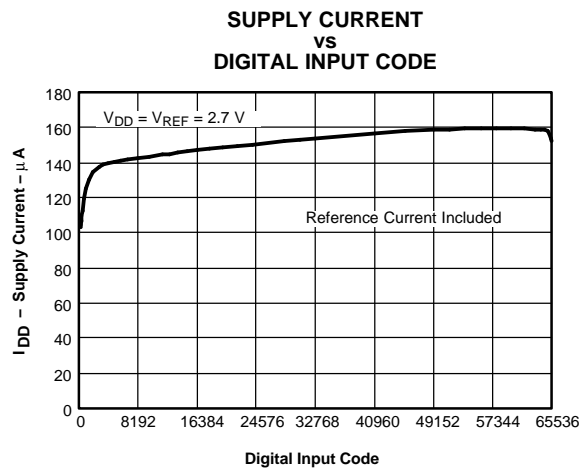

Figure 34.

TYPICAL CHARACTERISTICS: $V_{DD} = 2.7\text{ V}$ (continued)

At $T_A = 25^\circ\text{C}$, unless otherwise noted

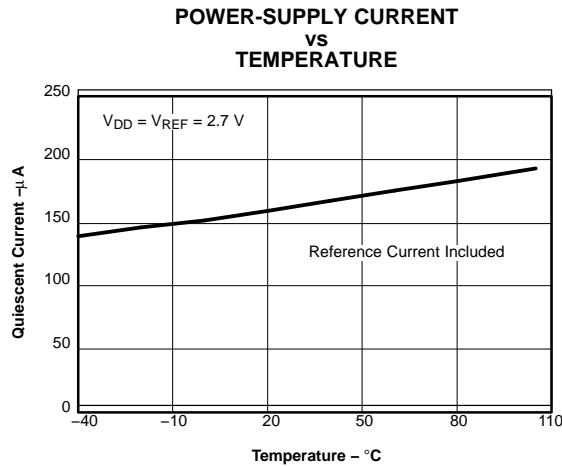

Figure 35.

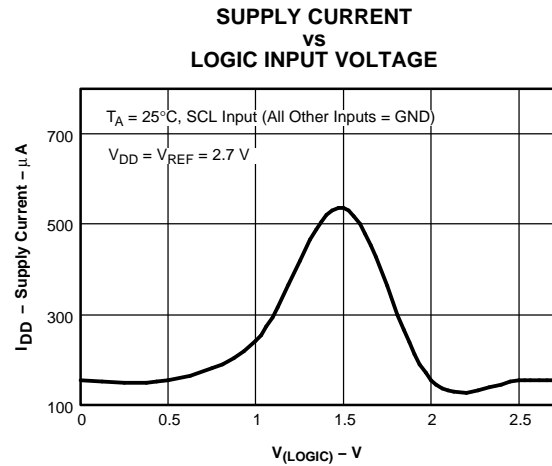

Figure 36.

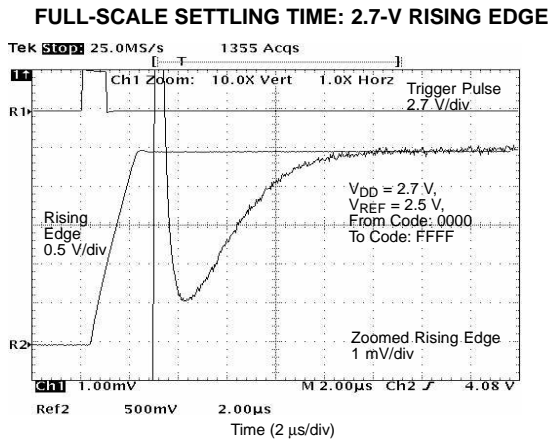

Figure 37.

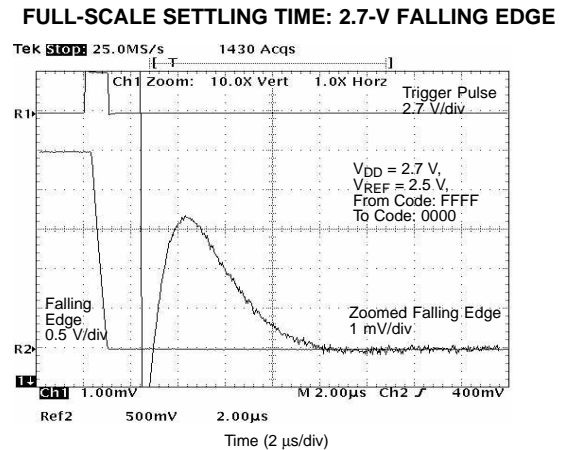

Figure 38.

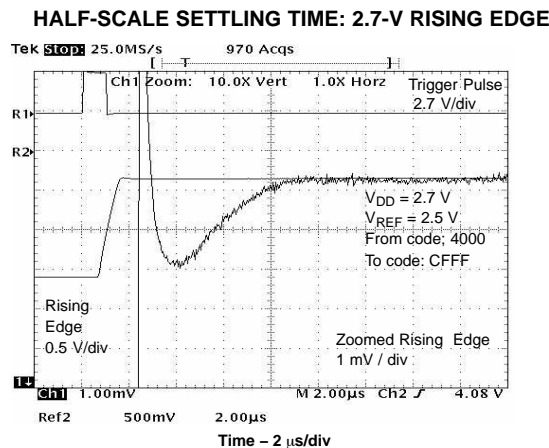

Figure 39.

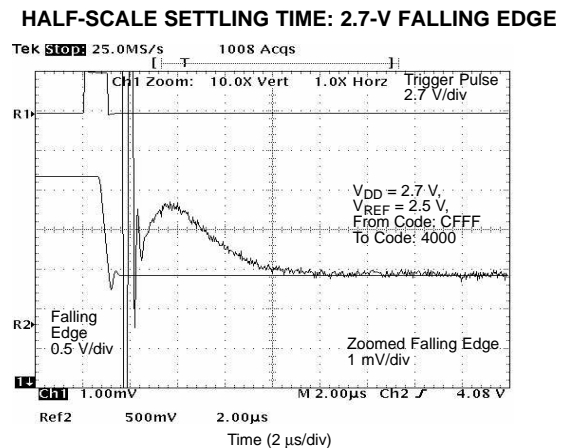

Figure 40.

TYPICAL CHARACTERISTICS: $V_{DD} = 2.7\text{ V}$ (continued)

At $T_A = 25^\circ\text{C}$, unless otherwise noted

GLITCH ENERGY: 2.7-V, 1-LSB STEP, RISING EDGE

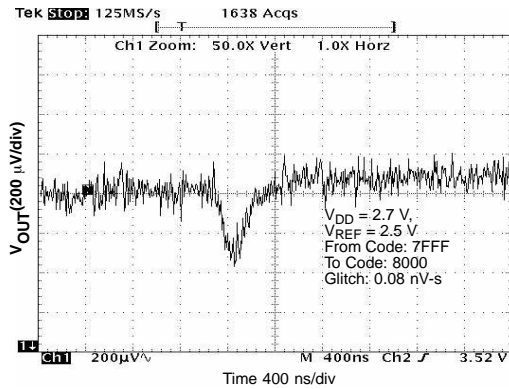

Figure 41.

GLITCH ENERGY: 2.7-V, 1-LSB STEP, FALLING EDGE

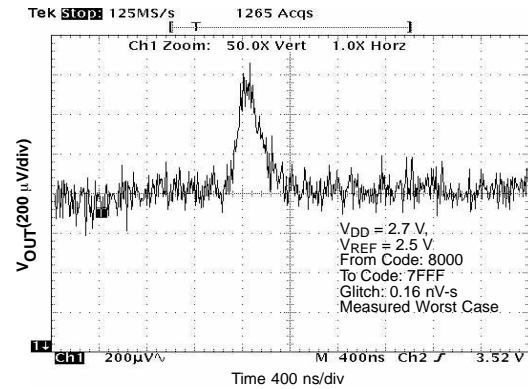

Figure 42.

GLITCH ENERGY: 2.7-V, 16-LSB STEP, RISING EDGE

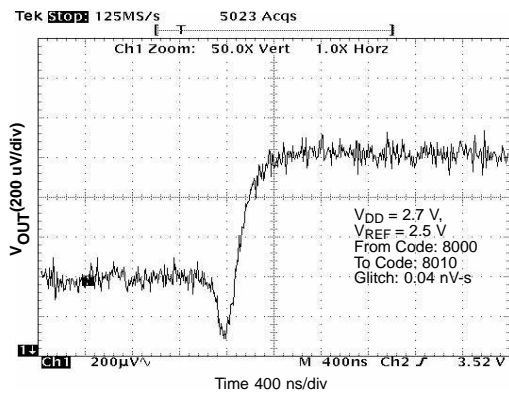

Figure 43.

GLITCH ENERGY: 2.7-V, 16-LSB STEP, FALLING EDGE

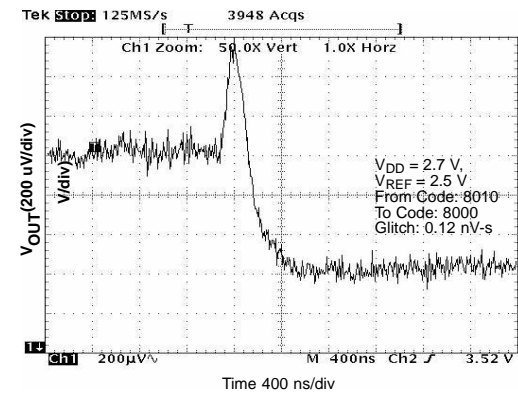

Figure 44.

GLITCH ENERGY: 2.7-V, 256-LSB STEP, RISING EDGE

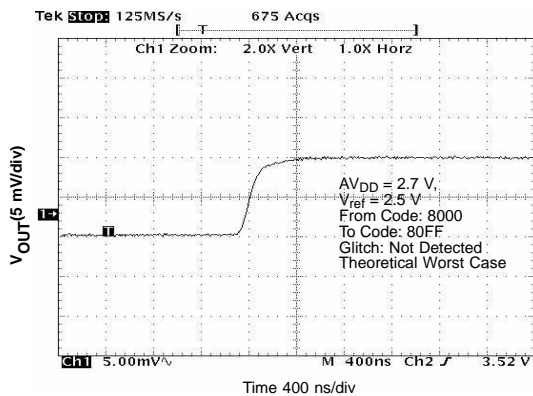

Figure 45.

GLITCH ENERGY: 2.7-V, 256-LSB STEP, FALLING EDGE

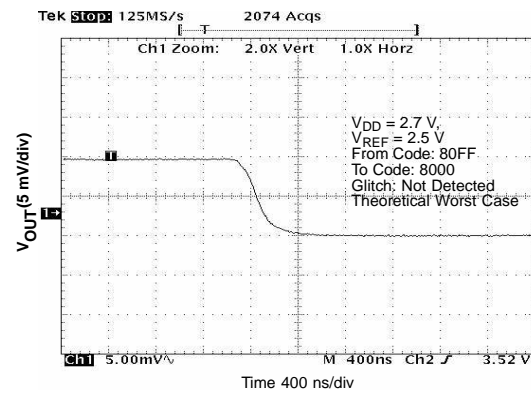

Figure 46.

THEORY OF OPERATION

DAC SECTION

The architecture consists of a string DAC followed by an output buffer amplifier. Figure 47 shows a block diagram of the DAC architecture.

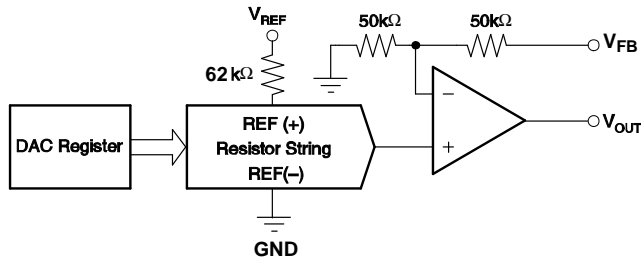

Figure 47. DAC8551 Architecture

The input coding to the DAC8551 is straight binary, so the ideal output voltage is given by:

$$V_{OUT}^X = \frac{D_{IN}}{65536} \times V_{REF}$$

where D_{IN} = decimal equivalent of the binary code that is loaded to the DAC register; it can range from 0 to 65535.

RESISTOR STRING

The resistor string section is shown in Figure 48. It is simply a string of resistors, each of value R. The code loaded into the DAC register determines at which node on the string the voltage is tapped off to be fed into the output amplifier by closing one of the switches connecting the string to the amplifier. It is monotonic because it is a string of resistors.

OUTPUT AMPLIFIER

The output buffer amplifier is capable of generating rail-to-rail voltages on its output, which gives an output range of 0 V to V_{DD} . It is capable of driving a load of 2 kΩ in parallel with 1000 pF to GND. The source and sink capabilities of the output amplifier can be seen in the typical curves. The slew rate is 1.8 V/μs with a full-scale setting time of 8 μs with the output unloaded.

The inverting input of the output amplifier is brought out to the V_{FB} pin. This allows for better accuracy in critical applications by tying the V_{FB} point and the amplifier output together directly at the load. Other signal conditioning circuitry may also be connected between these points for specific applications.

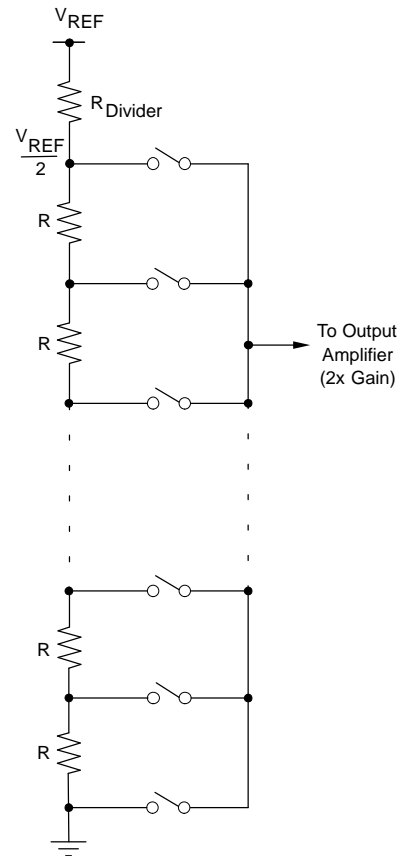

Figure 48. Resistor String

SERIAL INTERFACE

The DAC8551 has a 3-wire serial interface (\overline{SYNC} , SCLK, and D_{IN}), which is compatible with SPI™, QSPI™, and Microwire™ interface standards, as well as most DSPs. See the Serial Write Operation timing diagram for an example of a typical write sequence.

The write sequence begins by bringing the \overline{SYNC} line LOW. Data from the D_{IN} line is clocked into the 24-bit shift register on each falling edge of SCLK. The serial clock frequency can be as high as 30 MHz, making the DAC8551 compatible with high-speed DSPs. On the 24th falling edge of the serial clock, the last data bit is clocked in and the programmed function is executed (i.e., a change in DAC register contents and/or a change in the mode of operation).

At this point, the \overline{SYNC} line may be kept LOW or brought HIGH. In either case, it must be brought HIGH for a minimum of 33 ns before the next write sequence so that a falling edge of \overline{SYNC} can initiate the next write sequence. As previously mentioned, it must be brought HIGH again just before the next write sequence.

INPUT SHIFT REGISTER

The input shift register is 24 bits wide, as shown in Figure 49. The first six bits are *don't cares*. The next two bits (PD1 and PD0) are control bits that control which mode of operation the part is in (normal mode or any one of three power-down modes). A more complete description of the various modes is located in the Power-Down Modes section. The next 16 bits are the data bits. These are transferred to the DAC register on the 24th falling edge of SCLK.

SYNC INTERRUPT

In a normal write sequence, the $\overline{\text{SYNC}}$ line is kept LOW for at least 24 falling edges of SCLK and the DAC is updated on the 24th falling edge. However, if $\overline{\text{SYNC}}$ is brought HIGH before the 24th falling edge, it acts as an interrupt to the write sequence. The shift register is reset, and the write sequence is seen as invalid. Neither an update of the DAC register contents, or a change in the operating mode occurs, as shown in Figure 50.

POWER-ON RESET

The DAC8551 contains a power-on-reset circuit that controls the output voltage during power up. On power up, the DAC registers is filled with zeros and the output voltages is 0 V; it remains there until a valid write sequence is made to the DAC. This is useful in applications where it is important to know the state of the output of the DAC while it is in the process of powering up.

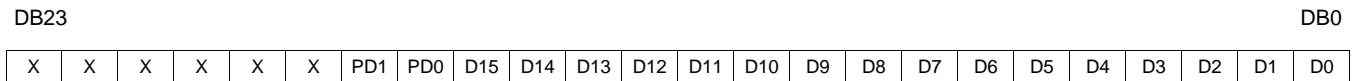

Figure 49. DAC8551 Data Input Register Format

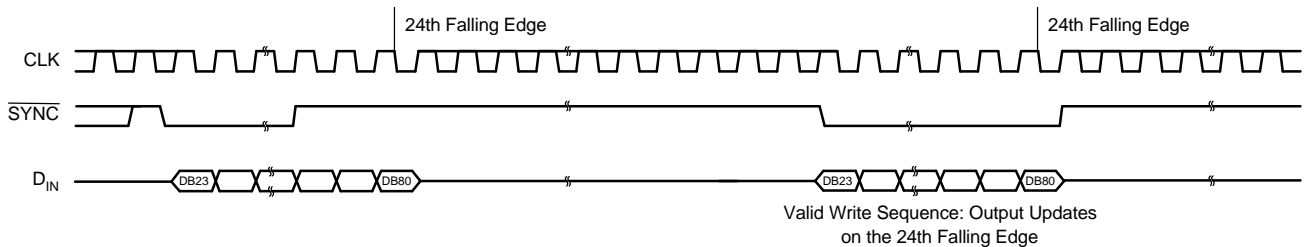

Figure 50. $\overline{\text{SYNC}}$ Interrupt Facility

POWER-DOWN MODES

The DAC8551 supports four separate modes of operation. These modes are programmable by setting two bits (PD1 and PD0) in the control register. Table 1 shows how the state of the bits corresponds to the mode of operation of the device.

Table 1. Modes of Operation for the DAC8551

PD1 (DB17)	PD0 (DB16)	OPERATING MODE
0	0	Normal Operation
–	–	Power-down modes
0	1	Output typically 1 kΩ to GND
1	0	Output typically 100 kΩ to GND
1	1	High-Z

When both bits are set to 0, the device works normally with its typical current consumption of 200 μA at 5 V. However, for the three power-down modes, the supply current falls to 200 nA at 5 V (50 nA at 3 V). Not only does the supply current fall, but the output stage is also internally switched from the output of the amplifier to a resistor network of known values. This has the advantage that the output impedance of the device is known while it is in power-down mode. There are three different options. The output is connected internally to GND through a 1-kΩ resistor, a 100-kΩ resistor, or it is left open-circuited (High-Z). The output stage is illustrated in Figure 51.

All analog circuitry is shut down when the power-down mode is activated. However, the contents of the DAC register are unaffected when in power down. The time to exit power-down is typically 2.5 μs for V_{DD} = 5 V, and 5 μs for V_{DD} = 3 V. See the Typical Characteristics for more information.

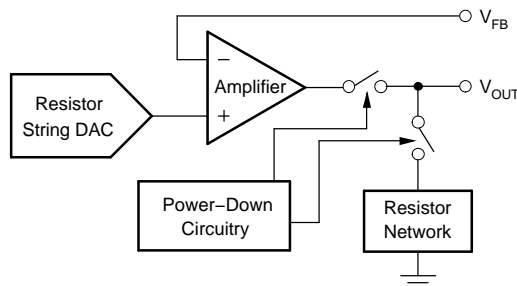

Figure 51. Output Stage During Power Down

MICROPROCESSOR INTERFACING

DAC8551 TO 8051 Interface

See Figure 52 for a serial interface between the DAC8551 and a typical 8051-type microcontroller.

The setup for the interface is as follows: TXD of the 8051 drives SCLK of the DAC8551, while RXD drives the serial data line of the device. The SYNC signal is derived from a bit-programmable pin on the port of the 8051. In this case, port line P3.3 is used. When data is to be transmitted to the DAC8551, P3.3 is taken LOW. The 8051 transmits data in 8-bit bytes; thus, only eight falling clock edges occur in the transmit cycle. To load data to the DAC, P3.3 is left LOW after the first eight bits are transmitted, then a second write cycle is initiated to transmit the second byte of data. P3.3 is taken HIGH following the completion of the third write cycle. The 8051 outputs the serial data in a format which has the LSB first. The DAC8551 requires its data with the MSB as the first bit received. The 8051 transmit routine must therefore take this into account, and mirror the data as needed.

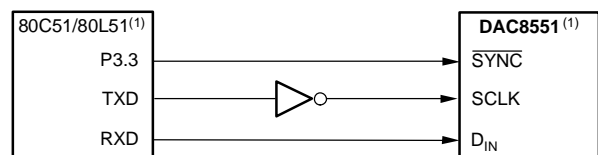

NOTE: (1) Additional pins omitted for clarity.

Figure 52. DAC8551 to 80C51/80L51 Interface

DAC8551 to Microwire Interface

Figure 53 shows an interface between the DAC8551 and any Microwire compatible device. Serial data is shifted out on the falling edge of the serial clock and is clocked into the DAC8551 on the rising edge of the SK signal.

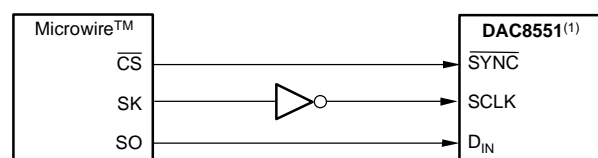

NOTE: (1) Additional pins omitted for clarity.

Figure 53. DAC8551 to Microwire Interface

DAC8551 to 68HC11 Interface

Figure 54 shows a serial interface between the DAC8551 and the 68HC11 microcontroller. SCK of the 68HC11 drives the SCLK of the DAC8551, while the MOSI output drives the serial data line of the DAC. The SYNC signal is derived from a port line (PC7), similar to the 8051 diagram.

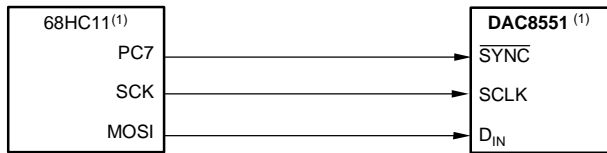

NOTE: (1) Additional pins omitted for clarity.

Figure 54. DAC8551 to 68HC11 Interface

The 68HC11 should be configured so that its CPOL bit is 0 and its CPHA bit is 1. This configuration causes data appearing on the MOSI output to be

valid on the falling edge of SCK. When data is being transmitted to the DAC, the $\overline{\text{SYNC}}$ line is held LOW (PC7). Serial data from the 68HC11 is transmitted in 8-bit bytes with only eight falling clock edges occurring in the transmit cycle. (Data is transmitted MSB first.) In order to load data to the DAC8551, PC7 is left LOW after the first eight bits are transferred, then a second and third serial write operation is performed to the DAC. PC7 is taken HIGH at the end of this procedure.

APPLICATION INFORMATION

USING THE REF02 AS A POWER SUPPLY FOR THE DAC8551

Due to the extremely low supply current required by the DAC8551, an alternative option is to use a REF02 +5-V precision voltage reference to supply the required voltage to the device, as shown in Figure 55.

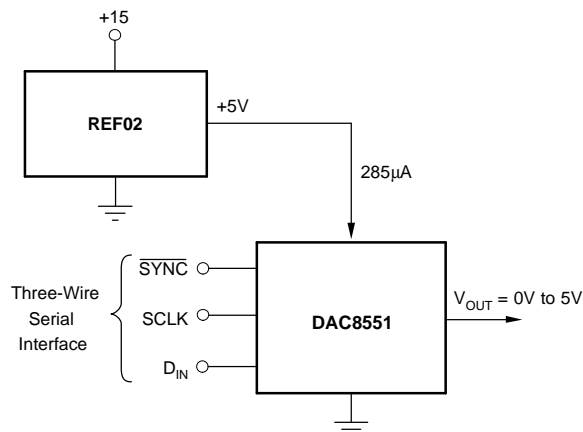

Figure 55. REF02 as a Power Supply to the DAC8551

This is especially useful if the power supply is quite noisy or if the system supply voltages are at some value other than 5 V. The REF02 outputs a steady supply voltage for the DAC8551. If the REF02 is used, the current it needs to supply to the DAC8551 is 200 μA . This is with no load on the output of the DAC. When a DAC output is loaded, the REF02 also needs to supply the current to the load. The total typical current required (with a 5-k Ω load on the DAC output) is:

$$200 \mu\text{A} + \frac{5 \text{ V}}{5 \text{ k}\Omega} = 1.2 \text{ mA} \quad (2)$$

The load regulation of the REF02 is typically 0.005%/mA, which results in an error of 299 μV for the 1.2-mA current drawn from it. This corresponds to a 3.9 LSB error.

BIPOLAR OPERATION USING THE DAC8551

The DAC8551 has been designed for single-supply operation, but a bipolar output range is also possible using the circuit in Figure 56. The circuit shown gives an output voltage range of $\pm V_{\text{REF}}$. Rail-to-rail operation at the amplifier output is achievable using an OPA703 as the output amplifier.

The output voltage for any input code can be calculated as follows:

$$V_{\text{O}} = \left[V_{\text{REF}} \times \left(\frac{D}{65536} \right) \times \left(\frac{R1 + R2}{R1} \right) - V_{\text{REF}} \times \left(\frac{R2}{R1} \right) \right]$$

where D represents the input code in decimal (0–65535).

With $V_{\text{REF}} = 5 \text{ V}$, $R1 = R2 = 10 \text{ k}\Omega$.

$$V_{\text{O}} = \left(\frac{10 \times D}{65536} \right) - 5 \text{ V} \quad (4)$$

This is an output voltage range of $\pm 5 \text{ V}$ with 0000_H corresponding to a -5 V output and FFFF_H corresponding to a 5 V output. Similarly, using $V_{\text{REF}} = 2.5 \text{ V}$, a $\pm 2.5\text{-V}$ output voltage range can be achieved.

LAYOUT

A precision analog component requires careful layout, adequate bypassing, and clean, well-regulated power supplies.

The DAC8551 offers single-supply operation, and it often is used in close proximity with digital logic,

microcontrollers, microprocessors, and digital signal processors. The more digital logic present in the design and the higher the switching speed, the more difficult it is to keep digital noise from appearing at the output.

Due to the single ground pin of the DAC8551, all return currents, including digital and analog return currents for the DAC, must flow through a single point. Ideally, GND would be connected directly to an analog ground plane. This plane would be separate from the ground connection for the digital components until they were connected at the power-entry point of the system.

The power applied to V_{DD} should be well regulated and low noise. Switching power supplies and DC/DC converters often have high-frequency glitches or spikes riding on the output voltage. In addition, digital components can create similar high-frequency spikes as their internal logic switches states. This noise can easily couple into the DAC output voltage through various paths between the power connections and analog output.

As with the GND connection, V_{DD} should be connected to a 5-V power-supply plane or trace that is separate from the connection for digital logic until they are connected at the power-entry point. In addition, a 1- μF to 10- μF capacitor and 0.1- μF bypass capacitor are strongly recommended. In some situations, additional bypassing may be required, such as a 100- μF electrolytic capacitor or even a *Pi* filter made up of inductors and capacitors – all designed to essentially low-pass filter the 5-V supply, removing the high-frequency noise.

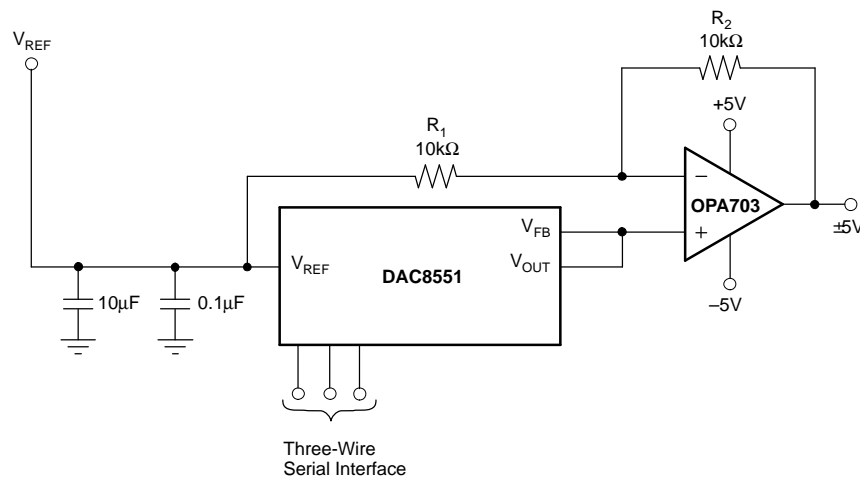

Figure 56. Bipolar Output Range

PACKAGING INFORMATION

Orderable Device	Status ⁽¹⁾	Package Type	Package Drawing	Pins	Package Qty	Eco Plan ⁽²⁾	Lead/Ball Finish	MSL Peak Temp ⁽³⁾
DAC8551IDGK	ACTIVE	MSOP	DGK	8	80	Green (RoHS & no Sb/Br)	CU	Level-1-260C-UNLIM
DAC8551IDGKR	ACTIVE	MSOP	DGK	8	2500	Green (RoHS & no Sb/Br)	CU	Level-1-260C-UNLIM
DAC8551IDGKRG4	ACTIVE	MSOP	DGK	8	2500	Green (RoHS & no Sb/Br)	CU	Level-1-260C-UNLIM
DAC8551IDGKT	ACTIVE	MSOP	DGK	8	250	Green (RoHS & no Sb/Br)	CU	Level-1-260C-UNLIM
DAC8551IDRBR	PREVIEW	SON	DRB	8	3000	TBD	Call TI	Call TI
DAC8551IDRBT	PREVIEW	SON	DRB	8	250	TBD	Call TI	Call TI

⁽¹⁾ The marketing status values are defined as follows:

ACTIVE: Product device recommended for new designs.

LIFEBUY: TI has announced that the device will be discontinued, and a lifetime-buy period is in effect.

NRND: Not recommended for new designs. Device is in production to support existing customers, but TI does not recommend using this part in a new design.

PREVIEW: Device has been announced but is not in production. Samples may or may not be available.

OBSOLETE: TI has discontinued the production of the device.

⁽²⁾ Eco Plan - The planned eco-friendly classification: Pb-Free (RoHS) or Green (RoHS & no Sb/Br) - please check <http://www.ti.com/productcontent> for the latest availability information and additional product content details.

TBD: The Pb-Free/Green conversion plan has not been defined.

Pb-Free (RoHS): TI's terms "Lead-Free" or "Pb-Free" mean semiconductor products that are compatible with the current RoHS requirements for all 6 substances, including the requirement that lead not exceed 0.1% by weight in homogeneous materials. Where designed to be soldered at high temperatures, TI Pb-Free products are suitable for use in specified lead-free processes.

Green (RoHS & no Sb/Br): TI defines "Green" to mean Pb-Free (RoHS compatible), and free of Bromine (Br) and Antimony (Sb) based flame retardants (Br or Sb do not exceed 0.1% by weight in homogeneous material)

⁽³⁾ MSL, Peak Temp. -- The Moisture Sensitivity Level rating according to the JEDEC industry standard classifications, and peak solder temperature.

Important Information and Disclaimer:The information provided on this page represents TI's knowledge and belief as of the date that it is provided. TI bases its knowledge and belief on information provided by third parties, and makes no representation or warranty as to the accuracy of such information. Efforts are underway to better integrate information from third parties. TI has taken and continues to take reasonable steps to provide representative and accurate information but may not have conducted destructive testing or chemical analysis on incoming materials and chemicals. TI and TI suppliers consider certain information to be proprietary, and thus CAS numbers and other limited information may not be available for release.

In no event shall TI's liability arising out of such information exceed the total purchase price of the TI part(s) at issue in this document sold by TI to Customer on an annual basis.

MECHANICAL DATA

DGK (S-PDSO-G8)

PLASTIC SMALL-OUTLINE PACKAGE

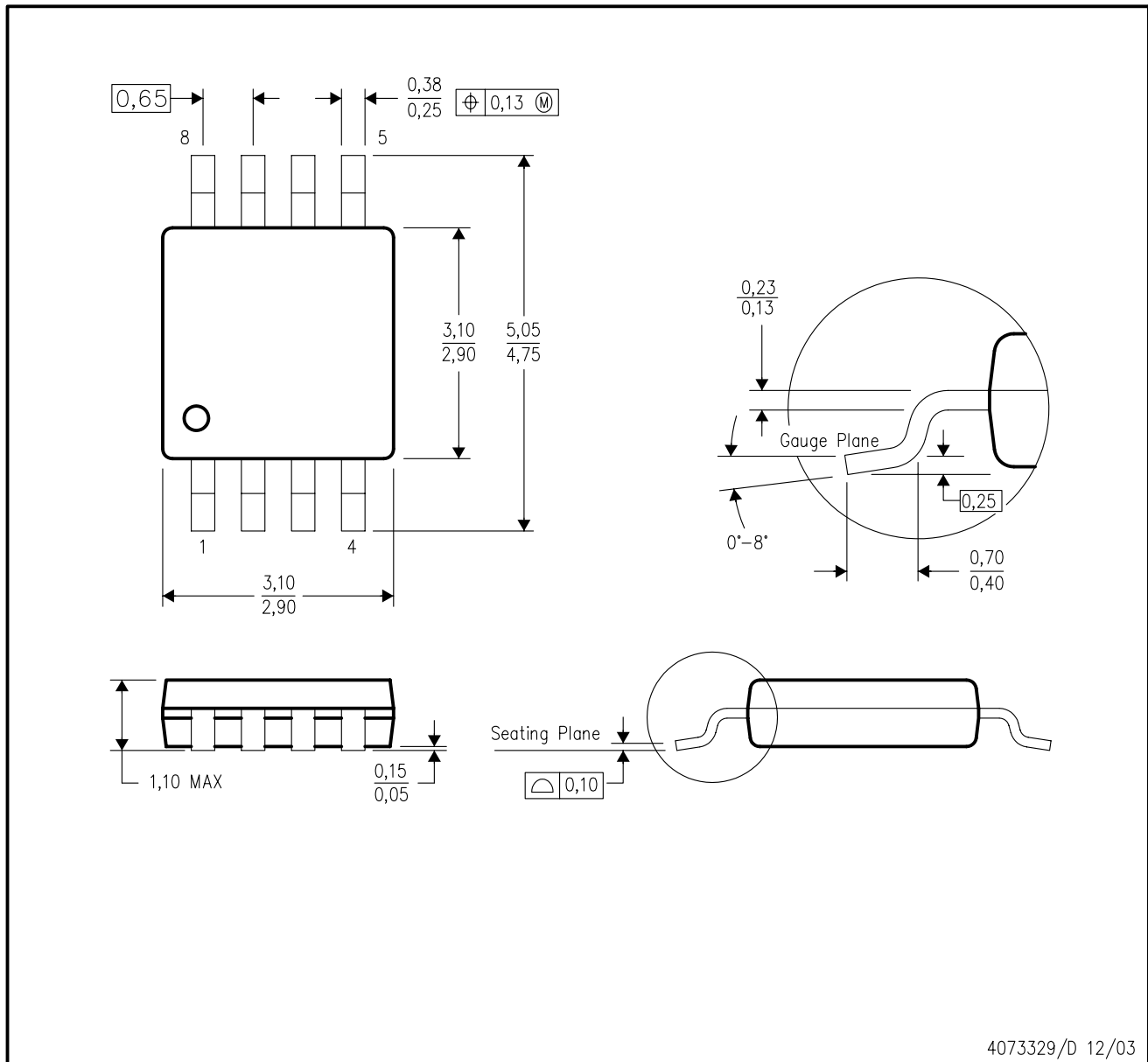

- NOTES:
- A. All linear dimensions are in millimeters.
 - B. This drawing is subject to change without notice.
 - C. Body dimensions do not include mold flash or protrusion.
 - D. Falls within JEDEC MO-187 variation AA.

IMPORTANT NOTICE

Texas Instruments Incorporated and its subsidiaries (TI) reserve the right to make corrections, modifications, enhancements, improvements, and other changes to its products and services at any time and to discontinue any product or service without notice. Customers should obtain the latest relevant information before placing orders and should verify that such information is current and complete. All products are sold subject to TI's terms and conditions of sale supplied at the time of order acknowledgment.

TI warrants performance of its hardware products to the specifications applicable at the time of sale in accordance with TI's standard warranty. Testing and other quality control techniques are used to the extent TI deems necessary to support this warranty. Except where mandated by government requirements, testing of all parameters of each product is not necessarily performed.

TI assumes no liability for applications assistance or customer product design. Customers are responsible for their products and applications using TI components. To minimize the risks associated with customer products and applications, customers should provide adequate design and operating safeguards.

TI does not warrant or represent that any license, either express or implied, is granted under any TI patent right, copyright, mask work right, or other TI intellectual property right relating to any combination, machine, or process in which TI products or services are used. Information published by TI regarding third-party products or services does not constitute a license from TI to use such products or services or a warranty or endorsement thereof. Use of such information may require a license from a third party under the patents or other intellectual property of the third party, or a license from TI under the patents or other intellectual property of TI.

Reproduction of information in TI data books or data sheets is permissible only if reproduction is without alteration and is accompanied by all associated warranties, conditions, limitations, and notices. Reproduction of this information with alteration is an unfair and deceptive business practice. TI is not responsible or liable for such altered documentation.

Resale of TI products or services with statements different from or beyond the parameters stated by TI for that product or service voids all express and any implied warranties for the associated TI product or service and is an unfair and deceptive business practice. TI is not responsible or liable for any such statements.

Following are URLs where you can obtain information on other Texas Instruments products and application solutions:

Products		Applications	
Amplifiers	amplifier.ti.com	Audio	www.ti.com/audio
Data Converters	dataconverter.ti.com	Automotive	www.ti.com/automotive
DSP	dsp.ti.com	Broadband	www.ti.com/broadband
Interface	interface.ti.com	Digital Control	www.ti.com/digitalcontrol
Logic	logic.ti.com	Military	www.ti.com/military
Power Mgmt	power.ti.com	Optical Networking	www.ti.com/opticalnetwork
Microcontrollers	microcontroller.ti.com	Security	www.ti.com/security
		Telephony	www.ti.com/telephony
		Video & Imaging	www.ti.com/video
		Wireless	www.ti.com/wireless

Mailing Address: Texas Instruments
Post Office Box 655303 Dallas, Texas 75265