

Actual information about approvals can be found on
<http://www.schurter.com/approvals>



C14



70° C



Standard- or Medical-Filter

Description

- Panel mount:
- Snap-in or screw-on mounting from front side
- 3 Functions:
- Connector Protection class I, Line switch 1- or 2-pole, Line filter in standard and medical version
- Quick connect terminals 6.3 x 0.8 mm
- Alternative: version without line filter [DC11](#)
- Substitute for type [KFB1](#); [KFB2](#)

Characteristics

- Compact design with optimal shielding
- All single elements are already wired
- Line switch non-illuminated
- Universal line filter for standard applications
- Ideal for application with high transient loads
- Qualified for use in equipment according IEC/EN 60950

Other versions on request:

- solder terminals
- other rocker marking
- line switch, illuminated
- Capacitance CX1
- medical version M80
- for protection class II

Technical data

Ratings IEC	1 - 10 A @ Ta 40 °C / 250 VAC; 50 Hz
Ratings UL/CSA	1 - 10 A @ Ta 40 °C / 125 VAC; 60 Hz
Leakage current	standard < 0.5 mA (250 V / 60 Hz) medical < 5 µA (250 V / 60 Hz)
Dielectric strength	> 1.7 kVDC between L-N > 2.7 kVDC between L/N-PE Test voltage (2 sec)
Allowable operation temp.	-25 °C to 85 °C
Climatic category	25/085/21, IEC 60068-1
Degree of protection	from front side IP40 acc. to IEC 60529
Protection class	Suitable for appliances with protection class I acc. to IEC 61140
Terminals	Quick connect terminals 6.3 x 0.8 mm
Panel thickness s	Screw-on: max 8 mm Mounting screw torque max 0.5 Nm Snap-in: 1 mm to 3 mm
Materials: Housing	Thermoplastic, black, UL 94V-0

Appliance-inlet /-outlet	C14 acc. to IEC/EN 60320-1, UL 498, CSA C22.2 no. 42 (for cold condition) pin-temperature 70 °C, 10 A, Protection class I
Line switch	Rocker switch 1- or 2-pole, non-illuminated, acc. to IEC 61058-1 Technical details GENERAL PRODUCT INFORMATION
Line filter	Standard and medical version, IEC 60939, IEC 60601-1, UL 1283, UL 544, EN 133 200, CSA C22.2 no. 8 Technical details GENERAL PRODUCT INFORMATION

Dimensions

Screw-on mounting

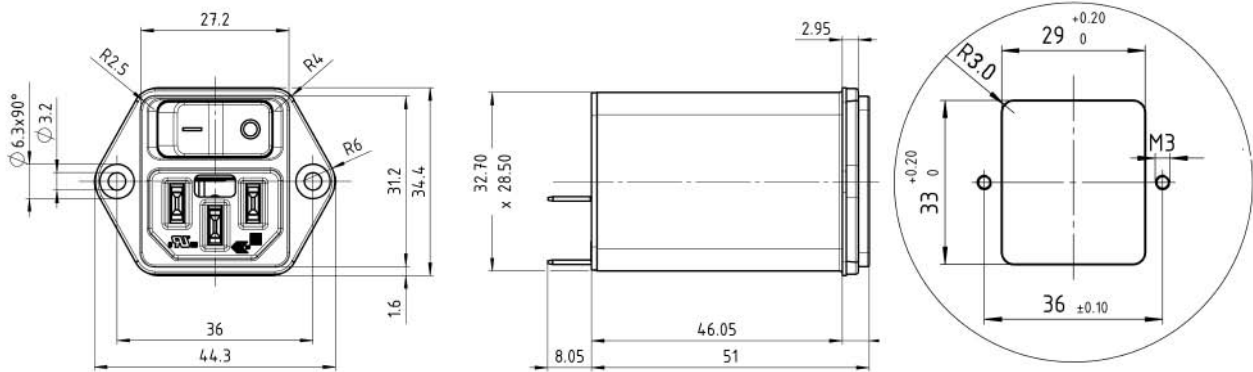

Snap-in mounting

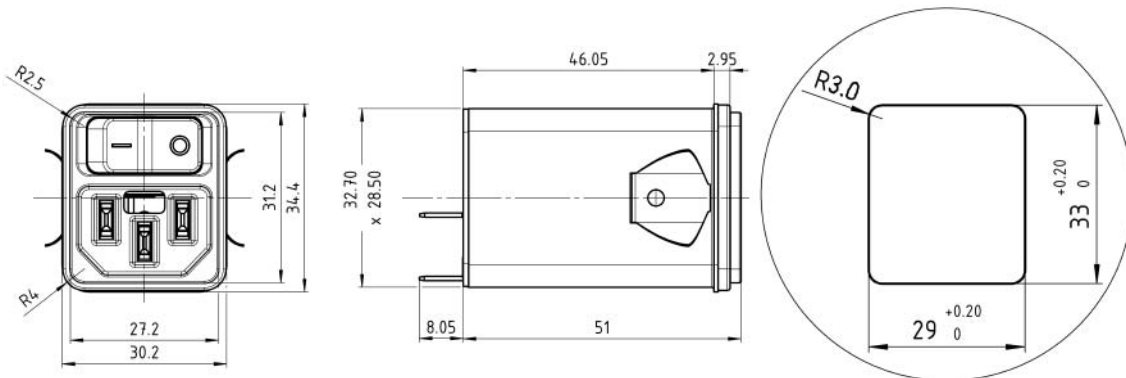

Technical data of filter-components

Rated current [A]	Filter-Type	Inductances L [mH]	Capacitance CX [nF]	Capacitance CY [nF]	R [MΩ]
1	Standard Version	2 x 10	100	2.2	1
2	Standard Version	2 x 4	100	2.2	1
4	Standard Version	2 x 1.5	100	2.2	1
6	Standard Version	2 x 0.8	100	2.2	1
10	Standard Version	2 x 0.3	100	2.2	1
1	Medical Version (M5)	2 x 10	100		1
2	Medical Version (M5)	2 x 4	100		1
4	Medical Version (M5)	2 x 1.5	100		1
6	Medical Version (M5)	2 x 0.8	100		1
10	Medical Version (M5)	2 x 0.3	100		1

Diagrams

Standard filter 1-pole

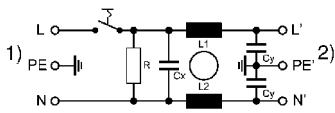

1) Line
2) Load

Standard filter 2-pole

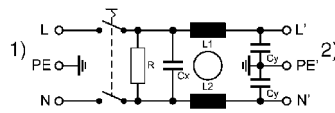

1) Line
2) Load

Medical filter 1-pole (M5)

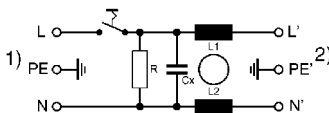

1) Line
2) Load

Medical filter 2-pole (M5)

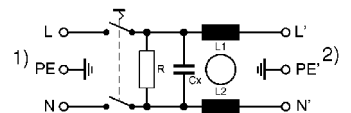

1) Line
2) Load

Attenuation loss

--- differential mode ____ common mode

Standard version

1 A

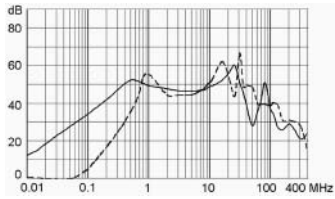

2 A

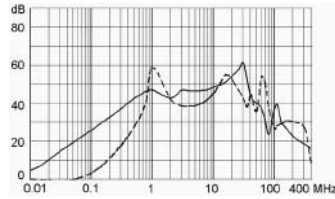

4 A

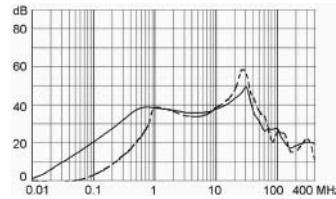

6 A

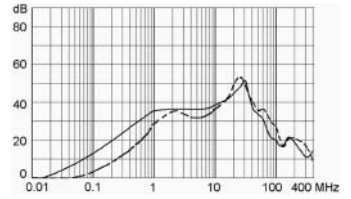

10 A

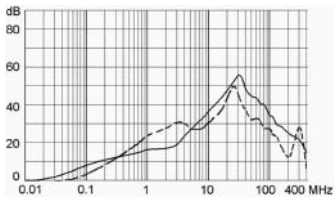

Medical version

1 A

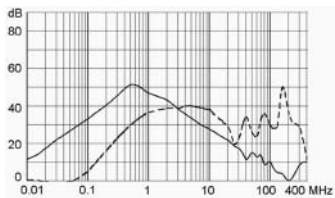

2 A

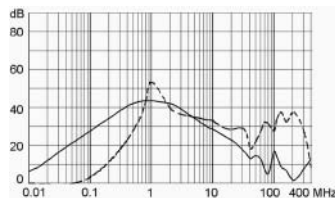

4 A

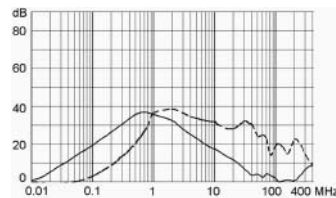

6 A

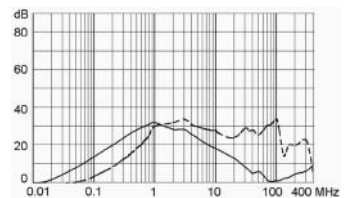

10 A

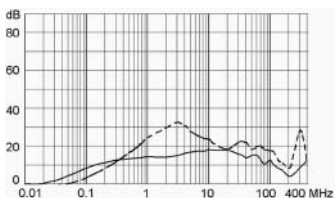

Variants

Order Number	Rated current [A]	Filter-Type	Panel mounting	Line switch
DC12.1102.103	1	Standard Version	Snap-in	1-pole
DC12.2102.103	2	Standard Version	Snap-in	1-pole
DC12.3102.103	4	Standard Version	Snap-in	1-pole
DC12.4102.103	6	Standard Version	Snap-in	1-pole
DC12.5102.103	10	Standard Version	Snap-in	1-pole
DC12.1102.101	1	Standard Version	Snap-in	2-pole
DC12.2102.101	2	Standard Version	Snap-in	2-pole
DC12.3102.101	4	Standard Version	Snap-in	2-pole
DC12.4102.101	6	Standard Version	Snap-in	2-pole
DC12.5102.101	10	Standard Version	Snap-in	2-pole
DC12.1102.003	1	Standard Version	Screw-on	1-pole
DC12.2102.003	2	Standard Version	Screw-on	1-pole
DC12.3102.003	4	Standard Version	Screw-on	1-pole
DC12.4102.003	6	Standard Version	Screw-on	1-pole
DC12.5102.003	10	Standard Version	Screw-on	1-pole
DC12.1102.001	1	Standard Version	Screw-on	2-pole
DC12.2102.001	2	Standard Version	Screw-on	2-pole
DC12.3102.001	4	Standard Version	Screw-on	2-pole
DC12.4102.001	6	Standard Version	Screw-on	2-pole
DC12.5102.001	10	Standard Version	Screw-on	2-pole
DC12.1202.103	1	Medical Version (M5)	Snap-in	1-pole
DC12.2202.103	2	Medical Version (M5)	Snap-in	1-pole
DC12.3202.103	4	Medical Version (M5)	Snap-in	1-pole
DC12.4202.103	6	Medical Version (M5)	Snap-in	1-pole
DC12.5202.103	10	Medical Version (M5)	Snap-in	1-pole
DC12.1202.101	1	Medical Version (M5)	Snap-in	2-pole
DC12.2202.101	2	Medical Version (M5)	Snap-in	2-pole
DC12.3202.101	4	Medical Version (M5)	Snap-in	2-pole
DC12.4202.101	6	Medical Version (M5)	Snap-in	2-pole
DC12.5202.101	10	Medical Version (M5)	Snap-in	2-pole
DC12.1202.003	1	Medical Version (M5)	Screw-on	1-pole
DC12.2202.003	2	Medical Version (M5)	Screw-on	1-pole
DC12.3202.003	4	Medical Version (M5)	Screw-on	1-pole
DC12.4202.003	6	Medical Version (M5)	Screw-on	1-pole
DC12.5202.003	10	Medical Version (M5)	Screw-on	1-pole
DC12.1202.001	1	Medical Version (M5)	Screw-on	2-pole
DC12.2202.001	2	Medical Version (M5)	Screw-on	2-pole
DC12.3202.001	4	Medical Version (M5)	Screw-on	2-pole
DC12.4202.001	6	Medical Version (M5)	Screw-on	2-pole
DC12.5202.001	10	Medical Version (M5)	Screw-on	2-pole

Packaging unit

10 Pcs

Accessories

ACCESSORIES