



Dual Ultrafast Voltage Comparator

ADCMP566

FEATURES

- 250 ps propagation delay input to output
- 50 ps propagation delay dispersion
- Differential ECL compatible outputs
- Differential latch control
- Robust input protection
- Input common-mode range -2.0 V to $+3.0\text{ V}$
- Input differential range $\pm 5\text{ V}$
- ESD protection $>3\text{ kV HBM}$, $>200\text{ V MM}$
- Power supply sensitivity $> 65\text{ dB}$
- 200 ps minimum pulsewidth
- 5 GHz equivalent input rise time bandwidth
- Typical output rise/fall of 165 ps

APPLICATIONS

- High speed instrumentation
- Scope and logic analyzer front ends
- Window comparators
- High speed line receivers and signal restoration
- Threshold detection
- Peak detection
- High speed triggers
- Patient diagnostics
- Disk drive read channel detection
- Hand-held test instruments
- Zero-crossing detectors
- Clock drivers
- Automatic test equipment

FUNCTIONAL BLOCK DIAGRAM

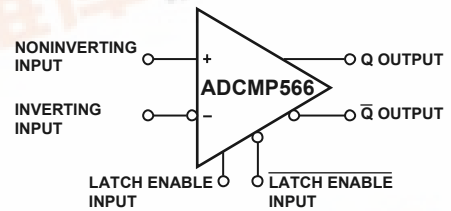

03633-0-001

Figure 1.

GENERAL DESCRIPTION

The ADCMP566 is an ultrafast voltage comparator fabricated on Analog Devices' proprietary XFCB process. The device features 250 ps propagation delay with less than 35 ps overdrive dispersion. Overdrive dispersion, a particularly important characteristic of high speed comparators, is a measure of the difference in propagation delay under differing overdrive conditions.

A fast, high precision differential input stage permits consistent propagation delay with a wide variety of signals in the common-mode range from -2.0 V to $+3.0\text{ V}$. Outputs are complementary digital signals fully compatible with ECL 10 K and 10 KH logic families. The outputs provide sufficient drive current to directly drive transmission lines terminated in $50\ \Omega$ to -2 V . A latch input is included, which permits tracking, track-and-hold, or sample-and-hold modes of operation.

The ADCMP566 is available in a 32-lead LFCSP package.



ADCMP566

TABLE OF CONTENTS

Specifications.....	3	Optimizing High Speed Performance	9
Absolute Maximum Ratings.....	5	Comparator Propagation Delay Dispersion	9
Thermal Considerations.....	5	Comparator Hysteresis	10
ESD Caution.....	5	Minimum Input Slew Rate Requirement	10
Pin Configuration and Function Descriptions.....	6	Typical Application Circuits	11
Timing Information	8	Typical Performance Characteristics	12
Application Information.....	9	Outline Dimensions	14
Clock Timing Recovery.....	9	Ordering Guide	14

REVISION HISTORY

Revision 0: Initial Version

SPECIFICATIONS

Table 1. ADCMP566 ELECTRICAL CHARACTERISTICS (V_{CC} = +5.0 V, V_{EE} = -5.2 V, T_A = 25°C, unless otherwise noted.)

Parameter	Symbol	Condition	Min	Typ	Max	Unit
DC INPUT CHARACTERISTICS (See Note)						
Input Common-Mode Range	V _{CM}		-2.0		+3.0	V
Input Differential Voltage			-5		+5	V
Input Offset Voltage	V _{OS}		-5.0	±1.0	+5.0	mV
Input Offset Voltage Channel Matching				±1.0		mV
Offset Voltage Tempco	DV _{OS} /dT			10.0		µV/°C
Input Bias Current	I _{BC}		-10	+24	+42	µA
Input Bias Current Tempco				10.0		nA/°C
Input Offset Current			-8.0	±0.5	+8.0	µA
Input Capacitance	C _{IN}			0.75		pF
Input Resistance, Differential Mode				100		kΩ
Input Resistance, Common Mode				600		kΩ
Open Loop Gain				60		dB
Common-Mode Rejection Ratio	CMRR	V _{CM} = -2.0 V to +3.0 V		69		dB
Hysteresis				±1.0		mV
LATCH ENABLE CHARACTERISTICS						
Latch Enable Common-Mode Range	V _{LCM}		-2.0		0	V
Latch Enable Differential Input Voltage	V _{LD}		0.4		2.0	V
Input High Current		@ 0.0 V	-12	+6	+12	µA
Input Low Current		@ -2.0 V	-12	+6	+12	µA
Latch Setup Time	t _S	250 mV overdrive		50		ps
Latch to Output Delay	t _{PLOH} , t _{PLOL}	250 mV overdrive		250		ps
Latch Pulsewidth	t _{PL}	250 mV overdrive		150		ps
Latch Hold Time	t _H	250 mV overdrive		75		ps
OUTPUT CHARACTERISTICS						
Output Voltage—High Level	V _{OH}	ECL 50 Ω to -2.0 V	-1.06		-0.81	V
Output Voltage—Low Level	V _{OL}	ECL 50 Ω to -2.0 V	-1.95		-1.65	V
Rise Time	t _R	20% to 80%		170		ps
Fall Time	t _F	20% to 80%		140		ps
AC PERFORMANCE						
Propagation Delay	t _{PD}	1 V overdrive		240		ps
Propagation Delay	t _{PD}	20 mV overdrive		290		ps
Propagation Delay Tempco				0.5		ps/°C
Prop Delay Skew—Rising Transition to Falling Transition				±10		ps
Within Device Propagation Delay Skew—Channel to Channel				±10		ps
Propagation Delay Dispersion vs. Duty Cycle		1 MHz, 1 ns t _R , t _F		±10		ps
Propagation Delay Dispersion vs. Overdrive		50 mV to 1.5 V		35		ps
Propagation Delay Dispersion vs. Overdrive		20 mV to 1.5 V		50		ps
Propagation Delay Dispersion vs. Slew Rate		0 V to 1 V swing, 20% to 80%, 50 and 600 ps t _R , t _F		50		ps
Propagation Delay Dispersion vs. Common-Mode Voltage		1 V swing, -1.5 V to 2.5 V _{CM}		5		ps
Equivalent Input Rise Time Bandwidth	BW	0 V to 1 V swing, 20% to 80%, 50 ps t _R , t _F		5000		MHz

ADCMP566

Parameter	Symbol	Condition	Min	Typ	Max	Unit
AC PERFORMANCE (continued)						
Toggle Rate	PW	>50% output swing		5		Gbps
Minimum Pulsewidth		Δt_{pd} from 10 ns to 200 ps < ± 25 ps		200		ps
Unit to Unit Propagation Delay Skew					± 10	
POWER SUPPLY						
Positive Supply Current	$I_{V_{CC}}$	@ +5.0 V	9	13	18	mA
Negative Supply Current	$I_{V_{EE}}$	@ -5.2 V	60	70	85	mA
Positive Supply Voltage	V_{CC}	Dual	4.75	5.0	5.25	V
Negative Supply Voltage	V_{EE}	Dual	-4.96	-5.2	-5.45	V
Power Dissipation		Dual, without load	375	450	525	mW
Power Dissipation		Dual, with load		550		mW
Power Supply Sensitivity— V_{CC}	$PSS_{V_{CC}}$			68		dB
Power Supply Sensitivity— V_{EE}	$PSS_{V_{EE}}$			85		dB

NOTE: Under no circumstances should the input voltages exceed the supply voltages.

ABSOLUTE MAXIMUM RATINGS

Table 2. ADCMP566 Absolute Maximum Ratings

	Parameter	Rating
Supply Voltages	Positive Supply Voltage (V_{CC} to GND)	-0.5 V to +6.0 V
	Negative Supply Voltage (V_{EE} to GND)	-6.0 V to +0.5 V
	Ground Voltage Differential	-0.5 V to +0.5 V
Input Voltages	Input Common-Mode Voltage	-3.0 V to +4.0 V
	Differential Input Voltage	-7.0 V to +7.0 V
	Input Voltage, Latch Controls	V_{EE} to 0.5 V
Output	Output Current	30 mA
Temperature	Operating Temperature, Ambient	-40°C to +85°C
	Operating Temperature, Junction	125°C
	Storage Temperature Range	-65°C to +150°C

Stress above those listed under Absolute Maximum Ratings may cause permanent damage to the device. This is a stress rating only and functional operation of the device at these or any other conditions above those indicated in the operational sections of this specification is not implied. Exposure to absolute maximum rating conditions for extended periods may affect device reliability.

ESD CAUTION

ESD (electrostatic discharge) sensitive device. Electrostatic charges as high as 4000 V readily accumulate on the human body and test equipment and can discharge without detection. Although this product features proprietary ESD protection circuitry, permanent damage may occur on devices subjected to high energy electrostatic discharges. Therefore, proper ESD precautions are recommended to avoid performance degradation or loss of functionality.



THERMAL CONSIDERATIONS

The ADCMP566 LFCSP 32-lead package option has a θ_{JA} (junction-to-ambient thermal resistance) of 27.2°C/W in still air.

ADCMP566

PIN CONFIGURATION AND FUNCTION DESCRIPTIONS

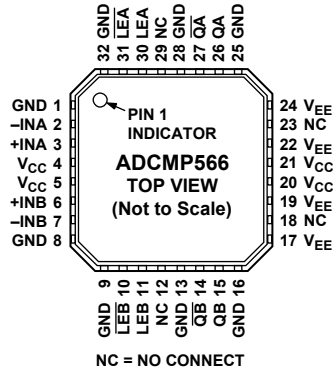

03633-0-002

Figure 2. ADCMP566 Pin Configuration

Table 3. ADCMP566 Pin Descriptions

Pin No.	Mnemonic	Function
1	GND	Analog Ground
2	-INA	Inverting analog input of the differential input stage for Channel A. The inverting A input must be driven in conjunction with the noninverting A input.
3	+INA	Noninverting analog input of the differential input stage for Channel A. The noninverting A input must be driven in conjunction with the inverting A input.
4	V _{CC}	Positive Supply Terminal
5	V _{CC}	Positive Supply Terminal
6	+INB	Noninverting analog input of the differential input stage for Channel B. The noninverting B input must be driven in conjunction with the inverting B input.
7	-INB	Inverting analog input of the differential input stage for Channel B. The inverting B input must be driven in conjunction with the noninverting B input.
8	GND	Analog Ground
9	GND	Analog Ground
10	LEB	One of two complementary inputs for Channel B Latch Enable. In the compare mode (logic low), the output will track changes at the input of the comparator. In the latch mode (logic high), the output will reflect the input state just prior to the comparator's being placed in the latch mode. LEB must be driven in conjunction with <u>LEB</u> .
11	LEB	One of two complementary inputs for Channel B Latch Enable. In the compare mode (logic high), the output will track changes at the input of the comparator. In the latch mode (logic low), the output will reflect the input state just prior to the comparator's being placed in the latch mode. LEB must be driven in conjunction with LEB.
12	NC	No Connect. Leave pin unconnected.
13	GND	Digital Ground
14	QB	One of two complementary outputs for Channel B. QB will be at logic low if the analog voltage at the noninverting input is greater than the analog voltage at the inverting input (provided the comparator is in the compare mode). See the LEB description (Pin 11) for more information.
15	QB	One of two complementary outputs for Channel B. QB will be at logic high if the analog voltage at the noninverting input is greater than the analog voltage at the inverting input (provided the comparator is in the compare mode). See the LEB description (Pin 11) for more information.
16	GND	Digital Ground
17	V _{EE}	Negative Supply Terminal
18	NC	No Connect. Leave pin unconnected.
19	V _{EE}	Negative Supply Terminal
20	V _{CC}	Positive Supply Terminal
21	V _{CC}	Positive Supply Terminal

Pin No.	Mnemonic	Function
22	V _{EE}	Negative Supply Terminal
23	NC	No Connect. Leave pin unconnected.
24	V _{EE}	Negative Supply Terminal
25	GND	Digital Ground
26	QA	One of two complementary outputs for Channel A. QA will be at logic high if the analog voltage at the noninverting input is greater than the analog voltage at the inverting input (provided the comparator is in the compare mode). See the LEA description (Pin 30) for more information.
27	\overline{QA}	One of two complementary outputs for Channel A. \overline{QA} will be at logic low if the analog voltage at the noninverting input is greater than the analog voltage at the inverting input (provided the comparator is in the compare mode). See the LEA description (Pin 30) for more information.
28	GND	Digital Ground
29	NC	No Connect. Leave pin unconnected.
30	LEA	One of two complementary inputs for Channel A Latch Enable. In the compare mode (logic high), the output will track changes at the input of the comparator. In the latch mode (logic low), the output will reflect the input state just prior to the comparator's being placed in the latch mode. LEA must be driven in conjunction with \overline{LEA} .
31	\overline{LEA}	One of two complementary inputs for Channel A Latch Enable. In the compare mode (logic low), the output will track changes at the input of the comparator. In the latch mode (logic high), the output will reflect the input state just prior to the comparator's being placed in the latch mode. LEA must be driven in conjunction with \overline{LEA} .
32	GND	Analog Ground

ADCMP566

TIMING INFORMATION

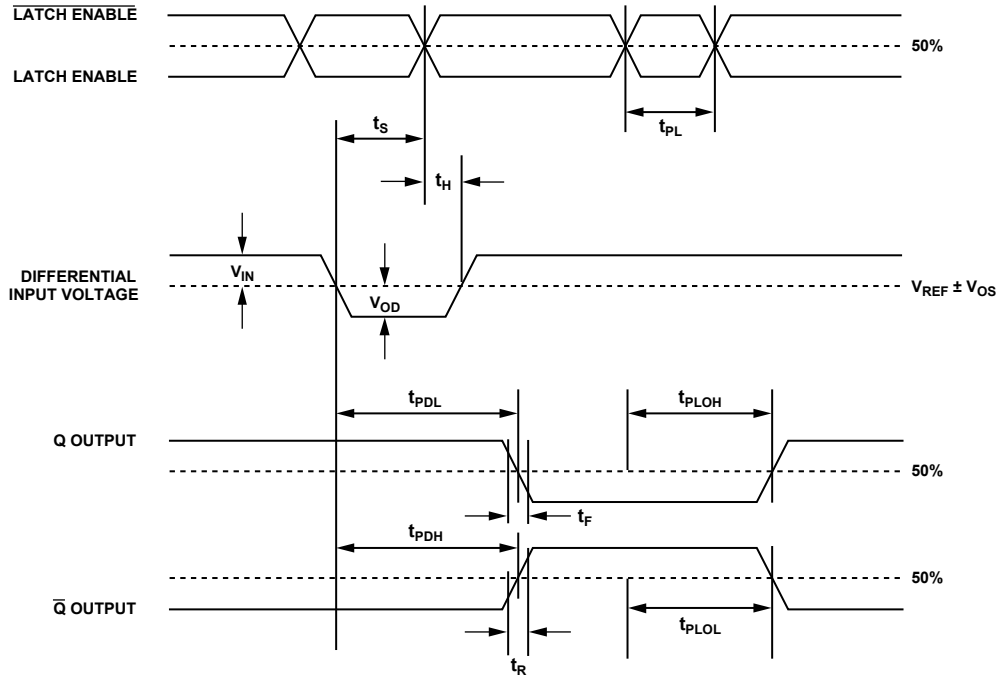

03633-0-003

Figure 3. System Timing Diagram

The timing diagram in Figure 3 shows the ADCMP566 compare and latch features. Table 4 describes the terms in the diagram.

Table 4. Timing Descriptions

Symbol	Timing	Description
t_{PDH}	Input to output high delay	Propagation delay measured from the time the input signal crosses the reference (\pm the input offset voltage) to the 50% point of an output low-to-high transition
t_{PDL}	Input to output low delay	Propagation delay measured from the time the input signal crosses the reference (\pm the input offset voltage) to the 50% point of an output high-to-low transition
t_{PLOH}	Latch enable to output high delay	Propagation delay measured from the 50% point of the Latch Enable signal low-to-high transition to the 50% point of an output low-to-high transition
t_{PLOL}	Latch enable to output low delay	Propagation delay measured from the 50% point of the Latch Enable signal low-to-high transition to the 50% point of an output high-to-low transition

Symbol	Timing	Description
t_H	Minimum hold time	Minimum time after the negative transition of the Latch Enable signal that the input signal must remain unchanged to be acquired and held at the outputs
t_{PL}	Minimum latch enable pulsewidth	Minimum time that the Latch Enable signal must be high to acquire an input signal change
t_S	Minimum setup time	Minimum time before the negative transition of the Latch Enable signal that an input signal change must be present to be acquired and held at the outputs
t_R	Output rise time	Amount of time required to transition from a low to a high output as measured at the 20% and 80% points
t_F	Output fall time	Amount of time required to transition from a high to a low output as measured at the 20% and 80% points
V_{OD}	Voltage overdrive	Difference between the differential input and reference input voltages

APPLICATION INFORMATION

The ADCMP566 comparators are very high speed devices. Consequently, high speed design techniques must be employed to achieve the best performance. The most critical aspect of any ADCMP566 design is the use of a low impedance ground plane. A ground plane, as part of a multilayer board, is recommended for proper high speed performance. Using a continuous conductive plane over the surface of the circuit board can create this, allowing breaks in the plane only for necessary signal paths. The ground plane provides a low inductance ground, eliminating any potential differences at different ground points throughout the circuit board caused by ground bounce. A proper ground plane also minimizes the effects of stray capacitance on the circuit board.

It is also important to provide bypass capacitors for the power supply in a high speed application. A 1 μ F electrolytic bypass capacitor should be placed within 0.5 inches of each power supply pin to ground. These capacitors will reduce any potential voltage ripples from the power supply. In addition, a 10 nF ceramic capacitor should be placed as close as possible from the power supply pins on the ADCMP566 to ground. These capacitors act as a charge reservoir for the device during high frequency switching.

The LATCH ENABLE input is active low (latched). If the latching function is not used, the LATCH ENABLE input should be grounded (ground is an ECL logic high), and the complementary input, $\overline{\text{LATCH ENABLE}}$, should be tied to -2.0 V. This will disable the latching function.

Occasionally, one of the two comparator stages within the ADCMP566 will not be used. The inputs of the unused comparator should not be allowed to float. The high internal gain may cause the output to oscillate (possibly affecting the comparator that is being used) unless the output is forced into a fixed state. This is easily accomplished by ensuring that the two inputs are at least one diode drop apart, while also appropriately connecting the LATCH ENABLE and $\overline{\text{LATCH ENABLE}}$ inputs as described above.

The best performance is achieved with the use of proper ECL terminations. The open emitter outputs of the ADCMP566 are designed to be terminated through 50 Ω resistors to -2.0 V, or any other equivalent ECL termination. If a -2.0 V supply is not available, an 82 Ω resistor to ground and a 130 Ω resistor to -5.2 V provide a suitable equivalent. If high speed ECL signals must be routed more than a centimeter, microstrip or stripline techniques may be required to ensure proper transition times and prevent output ringing.

CLOCK TIMING RECOVERY

Comparators are often used in digital systems to recover clock timing signals. High speed square waves transmitted over a distance, even tens of centimeters, can become distorted due to stray capacitance and inductance. Poor layout or improper termination can also cause reflections on the transmission line, further distorting the signal waveform. A high speed comparator can be used to recover the distorted waveform while maintaining a minimum of delay.

OPTIMIZING HIGH SPEED PERFORMANCE

As with any high speed comparator amplifier, proper design and layout techniques should be used to ensure optimal performance from the ADCMP566. The performance limits of high speed circuitry can easily be a result of stray capacitance, improper ground impedance, or other layout issues.

Minimizing resistance from source to the input is an important consideration in maximizing the high speed operation of the ADCMP566. Source resistance in combination with equivalent input capacitance could cause a lagged response at the input, thus delaying the output. The input capacitance of the ADCMP566 in combination with stray capacitance from an input pin to ground could result in several picofarads of equivalent capacitance. A combination of 3 k Ω source resistance and 5 pF of input capacitance yields a time constant of 15 ns, which is significantly slower than the sub 500 ps capability of the ADCMP566. Source impedances should be significantly less than 100 Ω for best performance.

Sockets should be avoided due to stray capacitance and inductance. If proper high speed techniques are used, the ADCMP566 should be free from oscillation when the comparator input signal passes through the switching threshold.

COMPARATOR PROPAGATION DELAY DISPERSION

The ADCMP566 has been specifically designed to reduce propagation delay dispersion over an input overdrive range of 100 mV to 1 V. Propagation delay overdrive dispersion is the change in propagation delay that results from a change in the degree of overdrive (how far the switching point is exceeded by the input). The overall result is a higher degree of timing accuracy since the ADCMP566 is far less sensitive to input variations than most comparator designs.

Propagation delay dispersion is a specification that is important in critical timing applications such as ATE, bench instruments, and nuclear instrumentation. Overdrive dispersion is defined

ADCMP566

as the variation in propagation delay as the input overdrive conditions are changed (Figure 4). For the ADCMP566, overdrive dispersion is typically 35 ps as the overdrive is changed from 100 mV to 1 V. This specification applies for both positive and negative overdrive since the ADCMP566 has equal delays for positive and negative going inputs.

The 35 ps propagation delay overdrive dispersion of the ADCMP566 offers considerable improvement of the 100 ps dispersion of other similar series comparators.

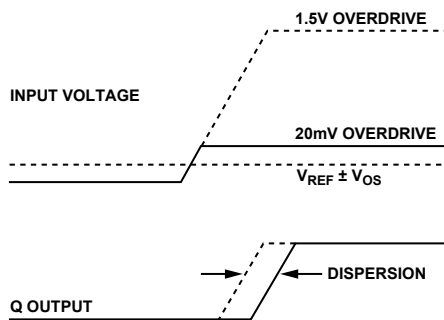

Figure 4. Propagation Delay Dispersion

COMPARATOR HYSTERESIS

The addition of hysteresis to a comparator is often useful in a noisy environment or where it is not desirable for the comparator to toggle between states when the input signal is at the switching threshold. The transfer function for a comparator with hysteresis is shown in Figure 5. If the input voltage approaches the threshold from the negative direction, the comparator will switch from a 0 to a 1 when the input crosses $+V_H/2$. The new switching threshold becomes $-V_H/2$. The comparator will remain in a 1 state until the threshold $-V_H/2$ is crossed coming from the positive direction. In this manner, noise centered on 0 V input will not cause the comparator to switch states unless it exceeds the region bounded by $\pm V_H/2$.

Positive feedback from the output to the input is often used to produce hysteresis in a comparator (Figure 9). The major problem with this approach is that the amount of hysteresis varies with the output logic levels, resulting in a hysteresis that is not symmetrical around zero.

Another method to implement hysteresis is generated by introducing a differential voltage between LATCH ENABLE and LATCH ENABLE inputs (Figure 10). Hysteresis generated in this manner is independent of output swing and is symmetrical around zero. The variation of hysteresis with input voltage is shown in Figure 6.

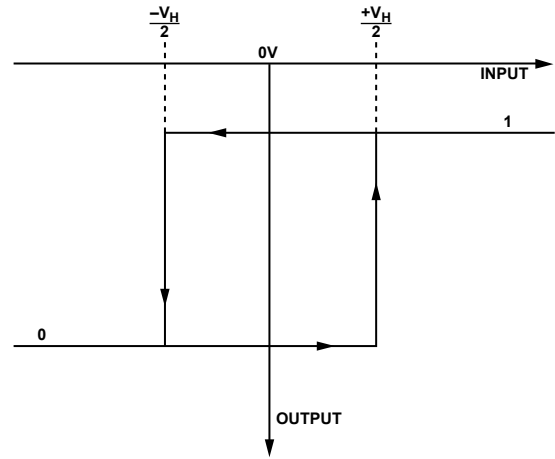

Figure 5. Comparator Hysteresis Transfer Function

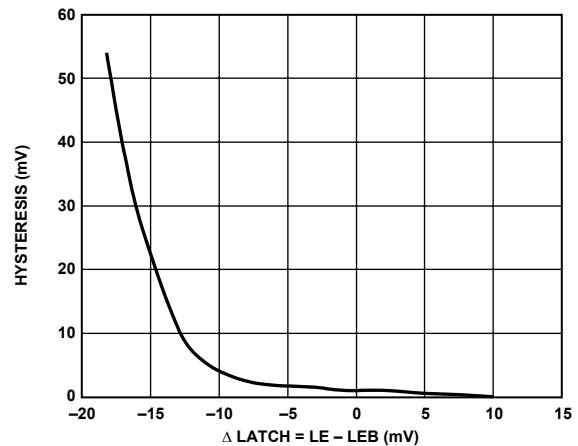
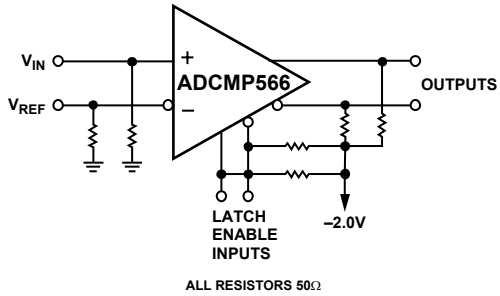

Figure 6. Comparator Hysteresis Transfer Function Using Latch Enable Input

MINIMUM INPUT SLEW RATE REQUIREMENT

As for all high speed comparators, a minimum slew rate must be met to ensure that the device does not oscillate when the input crosses the threshold. This oscillation is due in part to the high input bandwidth of the comparator and the parasitics of the package. Analog Devices recommends a slew rate of 5 V/μs or faster to ensure a clean output transition. If slew rates less than 5 V/μs are used, then hysteresis should be added to reduce the oscillation.

TYPICAL APPLICATION CIRCUITS



03633-0-007

Figure 7. High Speed Sampling Circuits

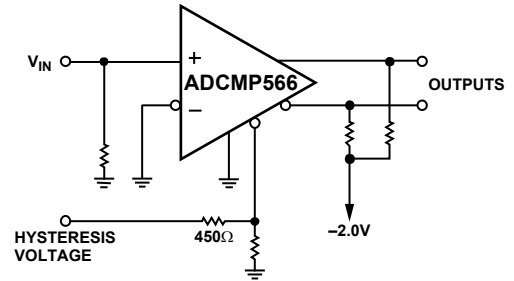

03633-0-010

Figure 10. Hysteresis Using Latch Enable Input

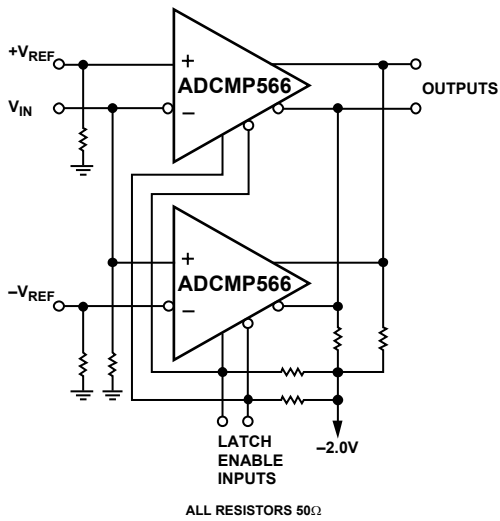

03633-0-008

Figure 8. High Speed Window Comparator

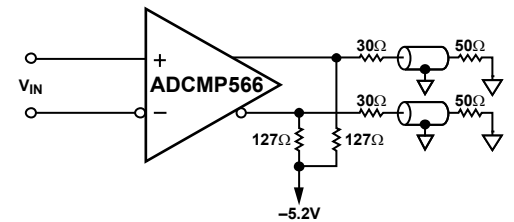
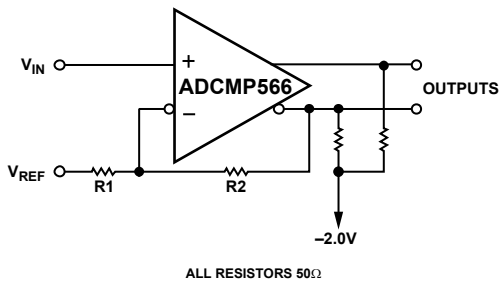

Figure 11. How to Interface an ECL Output to an Instrument with a 50Ω to Ground Input



03633-0-009

Figure 9. Hysteresis Using Positive Feedback

ADCMP566

TYPICAL PERFORMANCE CHARACTERISTICS

($V_{CC} = +5.0\text{ V}$, $V_{EE} = -5.2\text{ V}$, $T_A = 25^\circ\text{C}$, unless otherwise noted.)

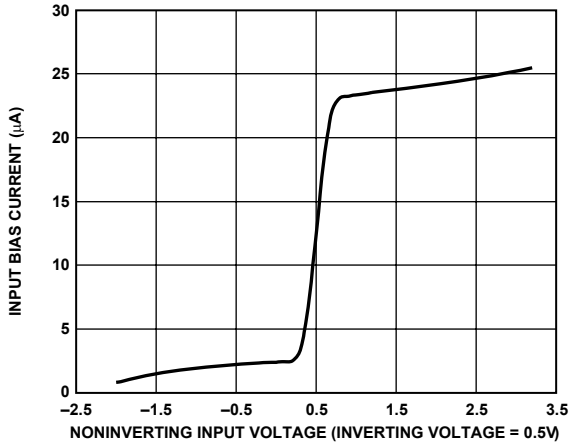

Figure 12. Input Bias Current vs. Input Voltage

03633-0-013

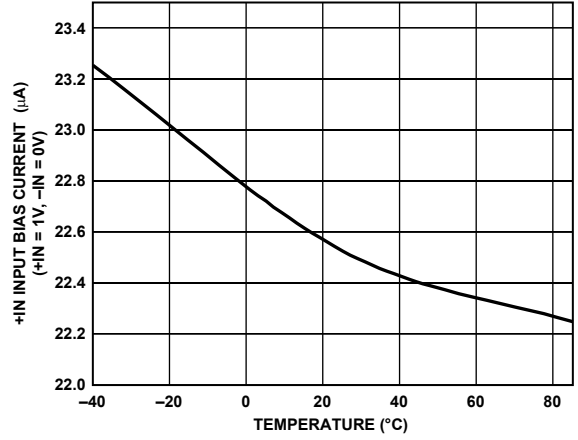

Figure 15. Input Bias Current vs. Temperature

03633-0-016

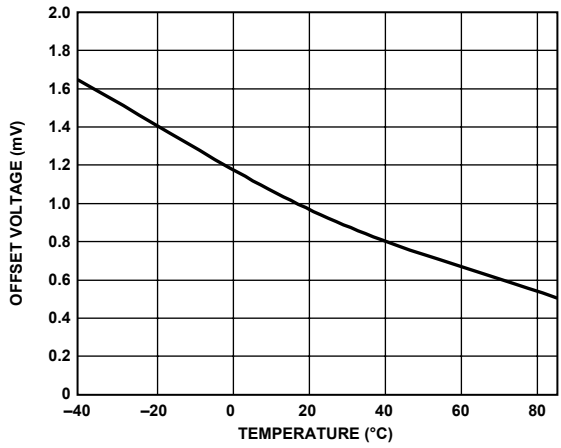

Figure 13. Input Offset Voltage vs. Temperature

03633-0-014

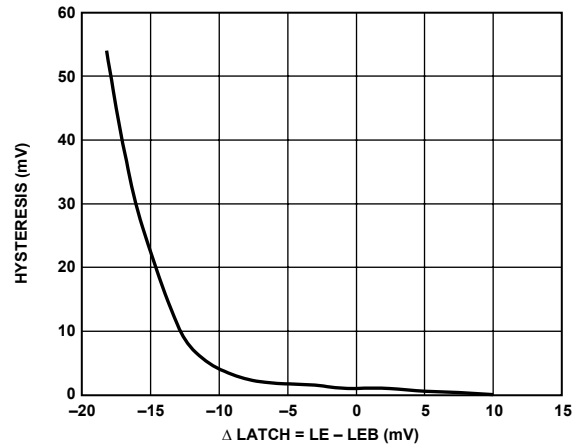

Figure 16. Hysteresis vs. ΔLatch

03633-0-017

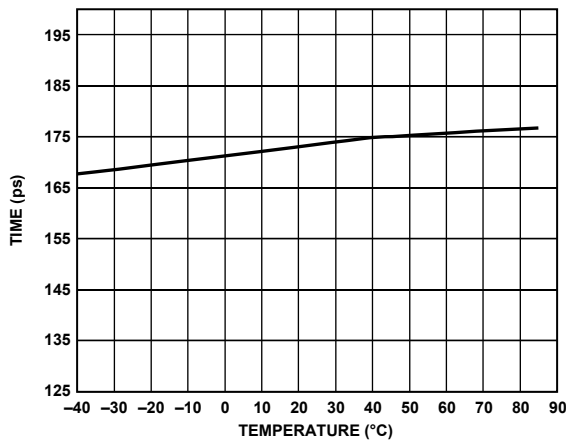

Figure 14. Rise Time vs. Temperature

03633-0-015

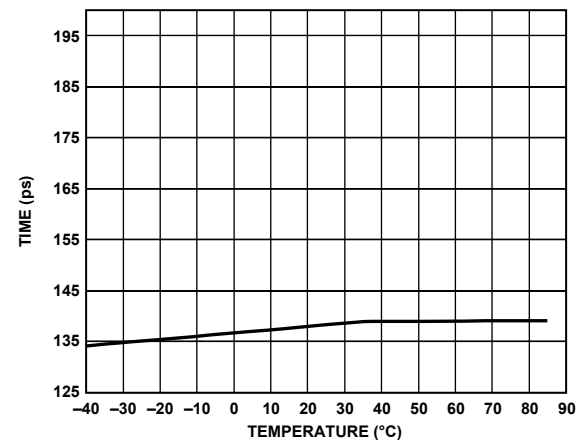

Figure 17. Fall Time vs. Temperature

03633-0-018

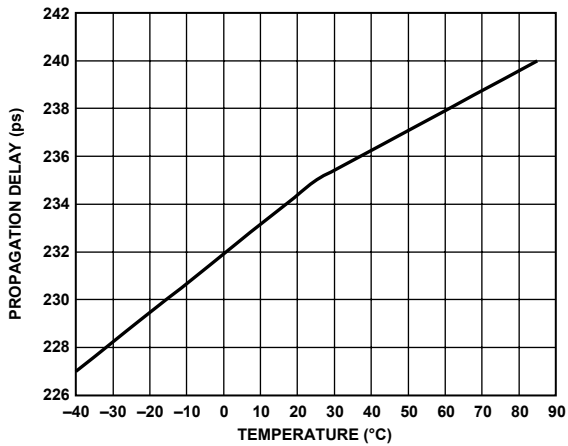

Figure 18. Propagation Delay vs. Temperature

03633-0-019

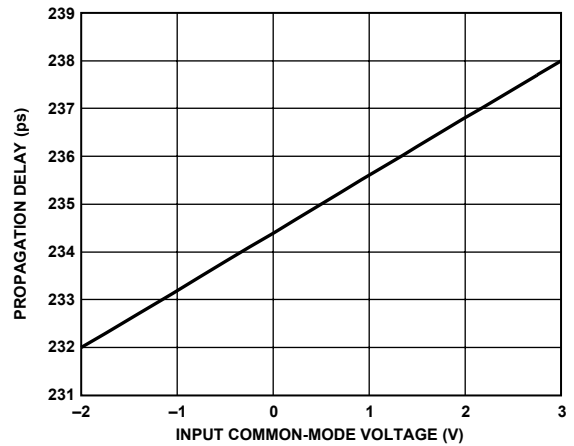

Figure 21. Propagation Delay vs. Common-Mode Voltage

03633-0-022

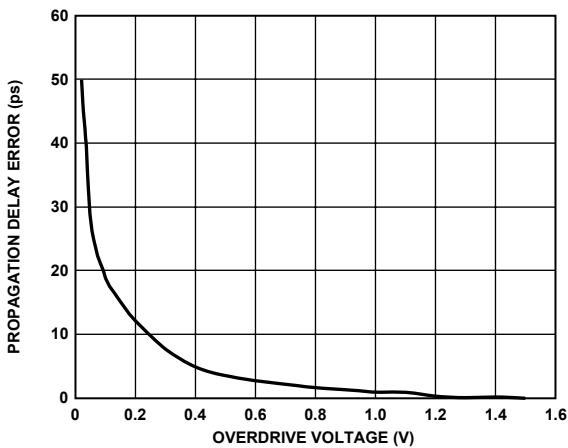

Figure 19. Propagation Delay Error vs. Overdrive Voltage

03633-0-020

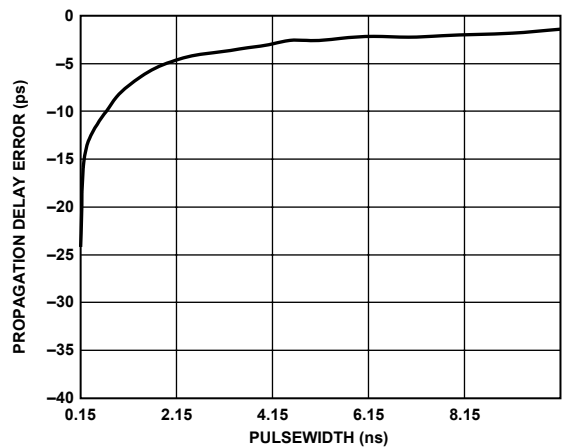

Figure 22. Propagation Delay Error vs. Pulsewidth

03633-0-023

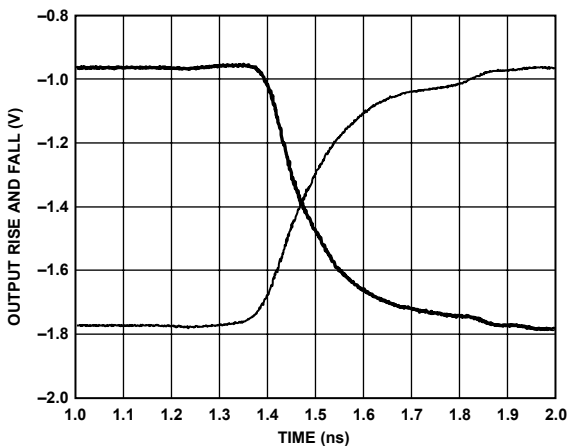
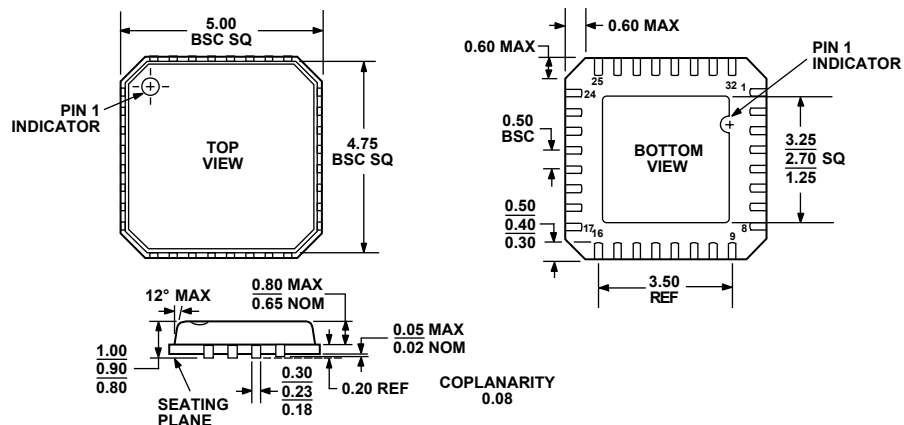

Figure 20. Rise and Fall of Outputs vs. Time

03633-0-021

ADCMP566

OUTLINE DIMENSIONS



COMPLIANT TO JEDEC STANDARDS MO-220-VHHD-2
 Figure 23. 32-Lead Lead Frame Chip Scale Package [LFCSPP]
 (CP-32)
 Dimensions shown in millimeters

ORDERING GUIDE

Model	Temperature Range	Package Description	Package Option
ADCMP566BCP	-40°C to +85°C	LFCSPP-32	CP-32

Notes

ADCMP566

Notes