

# DIODE MODULE

## DD130F

UL;E76102 (M)

Power Diode Module **DD130F** series are designed for various rectifier circuits. **DD130F** has two diode chips connected in series in a package and the mounting base is electrically isolated from elements for simple heatsink construction. Wide voltage rating up to, 1,600V is available for various input voltage.

- Isolated mounting base
- Two elements in a package for simple (single and three phase) bridge connections
- Highly reliable glass passivated chips
- High surge current capability

**(Applications)**

Various rectifiers, Battery chargers, DC motor drives

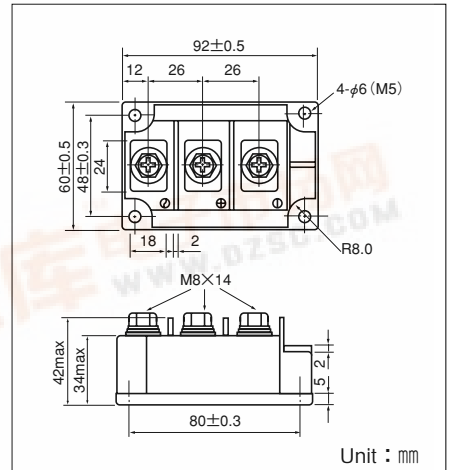
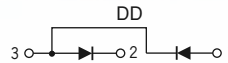

■ **Maximum Ratings**

(Tj=25°C unless otherwise specified)

Symbol	Item	Ratings				Unit
		DD130F40	DD130F80	DD130F120	DD130F160	
VRRM	Repetitive Peak Reverse Voltage	400	800	1200	1600	V
VRSM	Non-Repetitive Peak Reverse Voltage	480	960	1300	1700	V

Symbol	Item	Conditions	Ratings	Unit	
IF (AV)	Average Forward Current	Single phase, half wave, 180° conduction, Tc : 90°C	130	A	
IF (RMS)	R.M.S. Forward Current	Single phase, half wave, 180° conduction, Tc : 90°C	205	A	
IFSM	Surge Forward Current	½ cycle, 50/60Hz, peak value, non-repetitive	4000/4400	A	
I²t	I²t	Value for one cycle of surge current	80000	A²S	
Viso	Isolation Breakdown Voltage (R.M.S)	A.C.1minute	2500	°C	
Tj	Junction Temperature		-40 to +125	°C	
Tstg	Storage Temperature		-40 to +125	V	
	Mounting Torque	Mounting (M5)	Recommended Value 1.5-2.5 (15-25)	2.7 (28)	N·m (kgf·cm)
		Terminal (M8)	Recommended Value 8.8-10 (90-105)	11 (115)	
	Mass			510	g

■ **Electrical Characteristics**

Symbol	Item	Conditions	Ratings	Unit
IRRM	Repetitive Peak Reverse Current, max.	at VDRM, single phase, half wave. Tj=125°C	50	mA
VFM	Forward Voltage Drop, max.	Forward current 400A, Tj=25°C, Inst. measurement	1.40	V
Rth(j-c)	Thermal Impedance, max.	Junction to case	0.20	°C/W



### Maximum Forward Characteristics

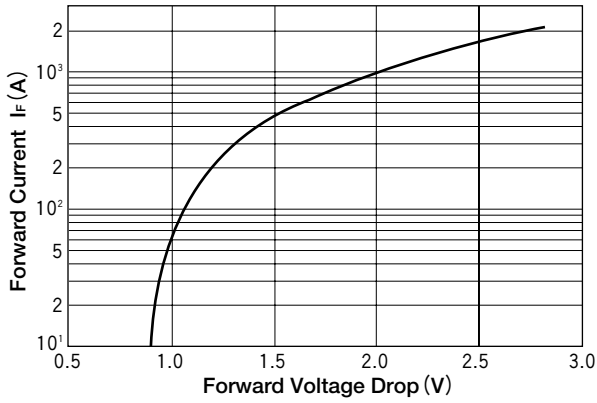

### Average Forward Current vs. Power Dissipation

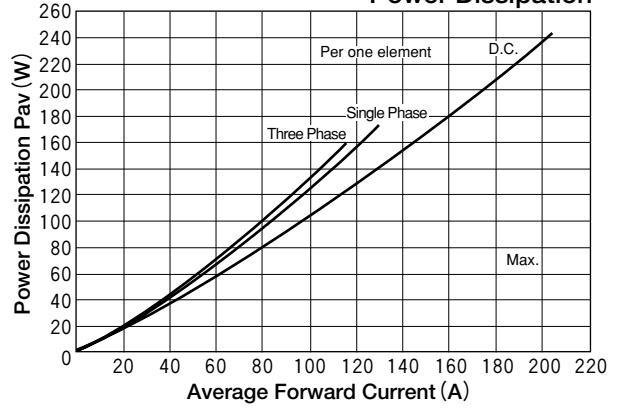

### Average Forward Current vs. Allowable Case Temperature

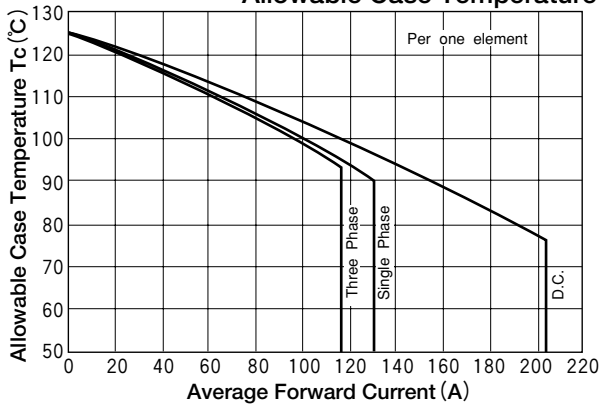

### Cycle Surge Forward Current Rating (Non-Repetitive)

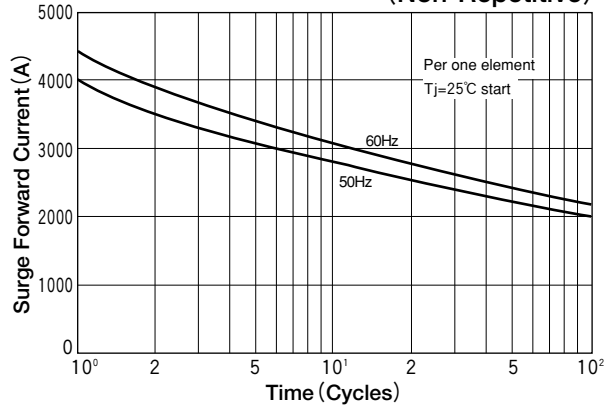

### Transient Thermal Impedance

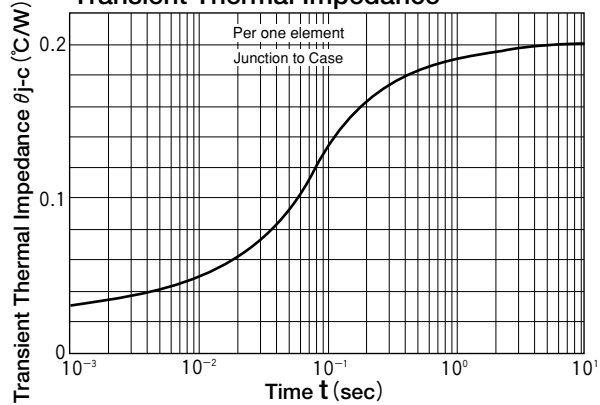

### Output Current

### B2; Two Pulse Bridge connection

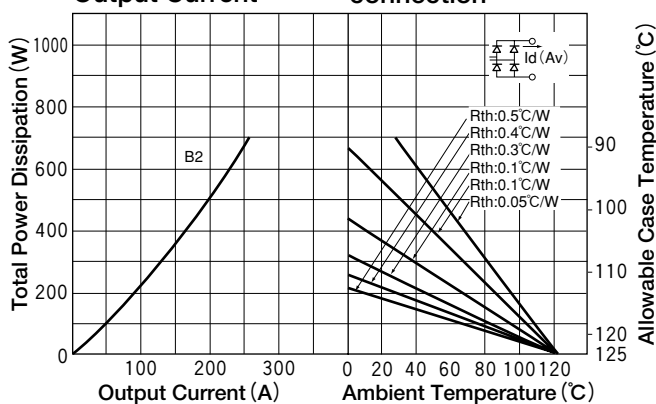

### Output Current

### B6; Six pulse Bridge connection

