

DIODE MODULE

DD25F/KD25F

UL:E76102 (M)

Power Diode Module DD25F series are designed for various rectifier circuits. DD25F has two diode chips connected in series in 25mm (1inch) width package and the mounting base is electrically isolated from elements for simple heatsink construction. Wide voltage rating up to, 1,600V is available for various input voltage.

- Isolated mounting base
- Two elements in a package for simple (single and three phase) bridge connections
- Highly reliable glass passivated chips
- High surge current capability

(Applications)

Various rectifiers, Battery chargers, DC motor drives

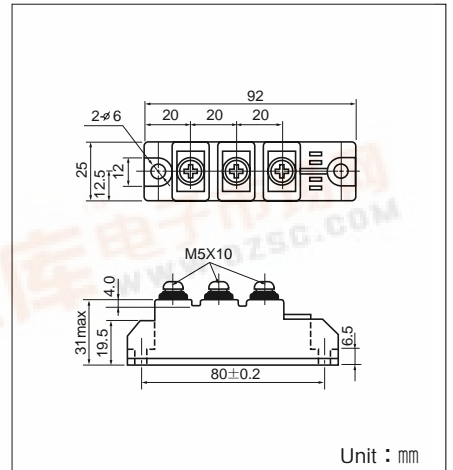
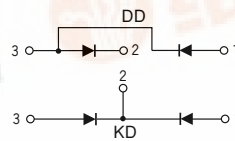

Maximum Ratings

(Tj=25°C unless otherwise specified)

Symbol	Item	Ratings				Unit
		DD25F40	DD25F80	DD25F120	DD25F160	
VRRM	Repetitive Peak Reverse Voltage	400	800	1200	1600	V
VRSM	Non-Repetitive Peak Reverse Voltage	480	960	1300	1700	V

Symbol	Item	Conditions	Ratings	Unit	
IF (AV)	Average Forward Current	Single phase, half wave, 180° conduction, Tc : 96°C	25	A	
IF (RMS)	R.M.S. Forward Current	Single phase, half wave, 180° conduction, Tc : 96°C	39	A	
IFSM	Surge Forward Current	½ cycle, 50/60Hz, peak Value, non-repetitive	530/580	A	
I²t	I²t	Value for one cycle of surge current	1400	A²S	
Viso	Isolation Breakdown Voltage (R.M.S.)	A.C.1minute	2500	°C	
Tj	Junction Temperature		-40 to +125	°C	
Tstg	Storage Temperature		-40 to +125	V	
	Mounting Torque	Mounting (M5)	Recommended Value 1.5-2.5 (15-25)	2.7 (28)	N·m (kgf·cm)
		Terminal (M5)	Recommended Value 1.5-2.5 (15-25)	2.7 (28)	
	Mass			170	g

Electrical Characteristics

Symbol	Item	Conditions	Ratings	Unit
IRRM	Repetitive Peak Reverse Current, max.	at VDRM, single phase, half wave. Tj=125°C	10	mA
VFM	Forward Voltage Drop, max.	Forward current 75A, Tj=25°C, Inst. measurement	1.55	V
Rth(j-c)	Thermal Impedance, max.	Junction to case	0.78	°C/W



DD25F/KD25F

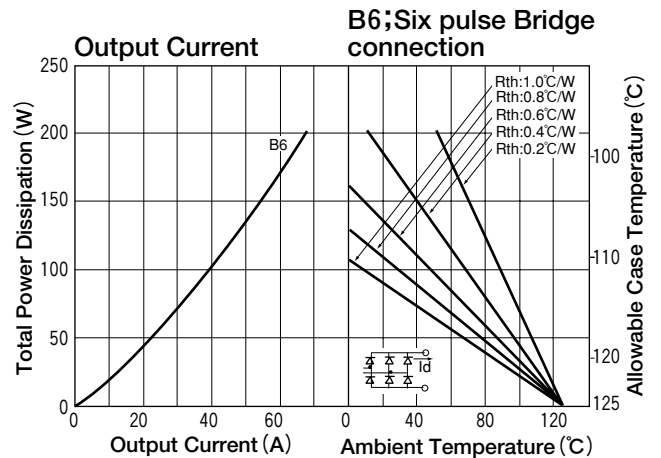
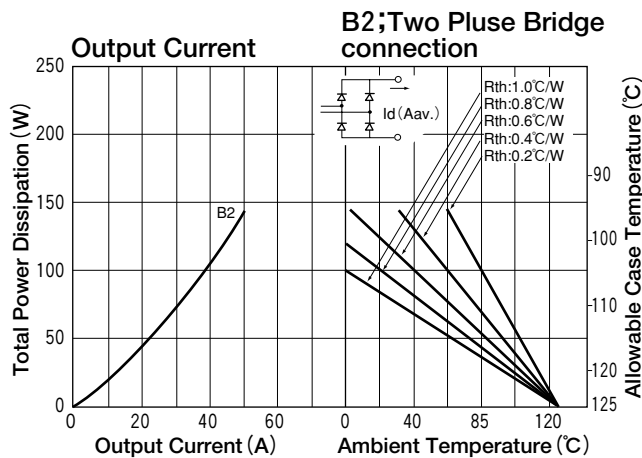
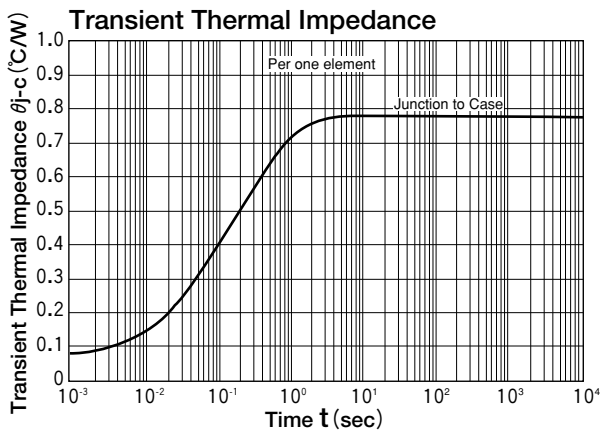
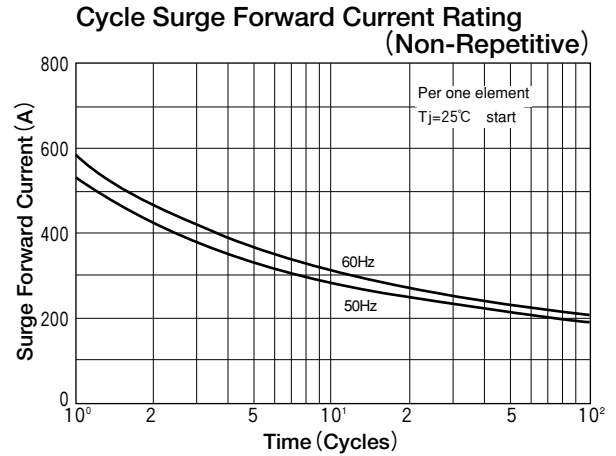
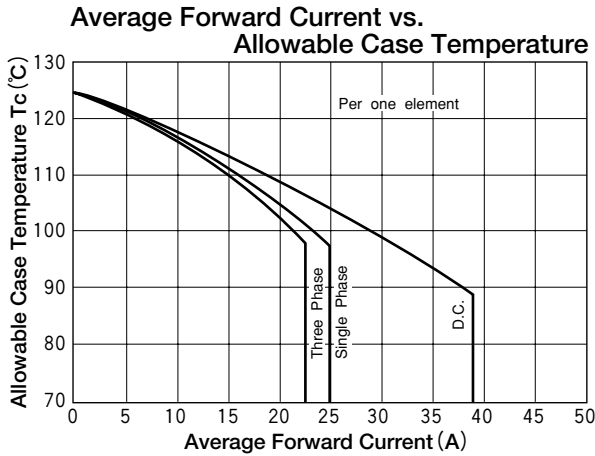
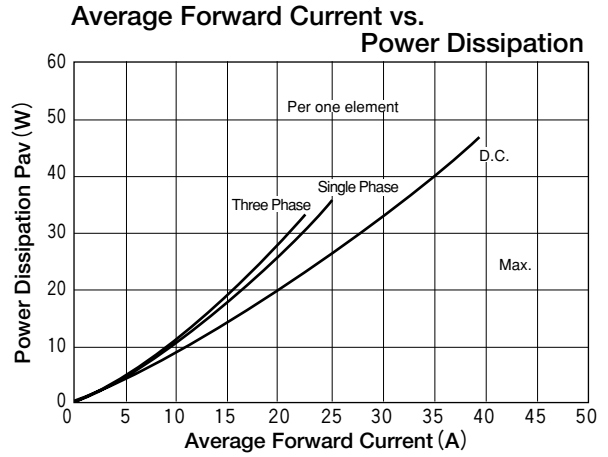
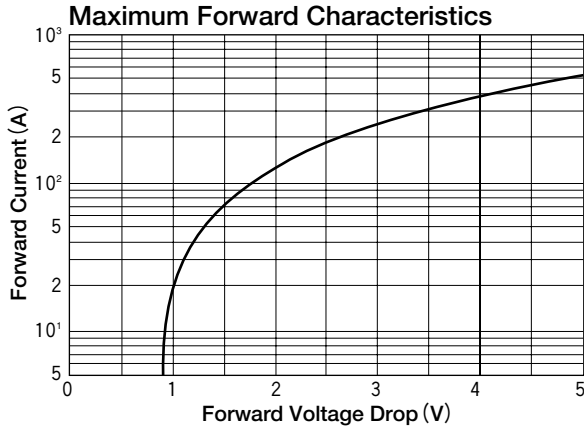

This datasheet has been download from:

www.datasheetcatalog.com

Datasheets for electronics components.