



DDTA (R1 = R2 SERIES) E

PNP PRE-BIASED SMALL SIGNAL SOT-523 SURFACE MOUNT TRANSISTOR

NEW PRODUCT

Features

- Epitaxial Planar Die Construction
- Complementary NPN Types Available (DDTC)
- Built-In Biasing Resistors, R1 = R2

Mechanical Data

- Case: SOT-523, Molded Plastic
- Case material - UL Flammability Rating 94V-0
- Moisture sensitivity: Level 1 per J-STD-020A
- Terminals: Solderable per MIL-STD-202, Method 208
- Terminal Connections: See Diagram
- Marking: Date Code and Marking Code (See Diagrams & Page 2)
- Weight: 0.002 grams (approx.)
- Ordering Information (See Page 2)

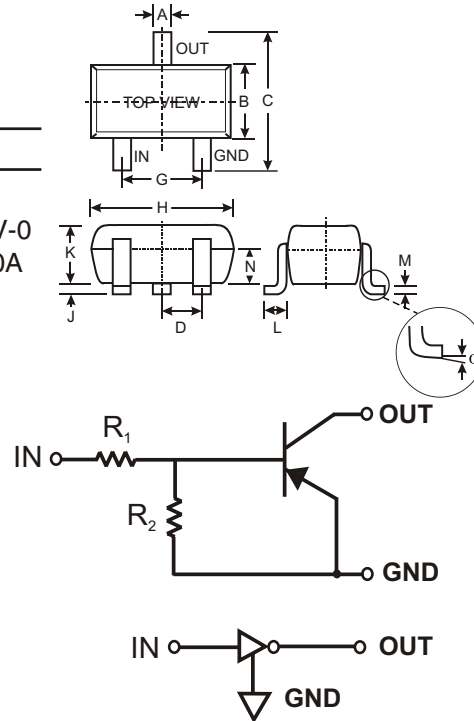

SOT-523			
Dim	Min	Max	Typ
A	0.15	0.30	0.22
B	0.75	0.85	0.80
C	1.45	1.75	1.60
D	—	—	0.50
G	0.90	1.10	1.00
H	1.50	1.70	1.60
J	0.00	0.10	0.05
K	0.60	0.80	0.75
L	0.10	0.30	0.22
M	0.10	0.20	0.12
N	0.45	0.65	0.50
α	0°	8°	—
All Dimensions in mm			

P/N	R1, R2 (NOM)	MARKING
DDTA123EE	2.2K Ω	P04
DDTA143EE	4.7K Ω	P08
DDTA114EE	10K Ω	P13
DDTA124EE	22K Ω	P17
DDTA144EE	47K Ω	P20
DDTA115EE	100K Ω	P24

SCHEMATIC DIAGRAM

Maximum Ratings @ T_A = 25°C unless otherwise specified

Characteristic	Symbol	Value	Unit
Supply Voltage, (3) to (1)	V _{CC}	-50	V
Input Voltage, (2) to (1)	V _{IN}	+10 to -12 +10 to -30 +10 to -40 +10 to -40 +10 to -40 +10 to -40 +10 to -40	V
Output Current	I _O	-100 -100 -50 -30 -30 -20	mA
Power Dissipation	P _d	150	mW
Thermal Resistance, Junction to Ambient Air (Note 1)	R _{θJA}	833	°C/W
Operating and Storage and Temperature Range	T _j , T _{STG}	-55 to +150	°C

Note: 1. Mounted on FR4 PC Board with recommended pad layout at <http://www.diodes.com/datasheets/ap02001.pdf>.

Electrical Characteristics @ $T_A = 25^\circ\text{C}$ unless otherwise specified

Characteristic		Symbol	Min	Typ	Max	Unit	Test Condition
Input Voltage		$V_{I(off)}$	-0.5	-1.1	—	V	$V_{CC} = 5V, I_O = 100\mu A$
		$V_{I(on)}$	—	-1.9	-3		$V_O = 0.3V, I_O = 20mA, DDTA123EE$ $V_O = 0.3V, I_O = 20mA, DDTA143EE$ $V_O = 0.3V, I_O = 10mA, DDTA114EE$ $V_O = 0.3V, I_O = 5mA, DDTA124EE$ $V_O = 0.3V, I_O = 2mA, DDTA144EE$ $V_O = 0.3V, I_O = 1mA, DDTA115EE$
Output Voltage		$V_{O(on)}$	—	-0.1	-0.3	V	$I_O/I_I = 10mA/0.5mA, DDTA123EE$ $I_O/I_I = 10mA/0.5mA, DDTA143EE$ $I_O/I_I = 10mA/0.5mA, DDTA114EE$ $I_O/I_I = 10mA/0.5mA, DDTA124EE$ $I_O/I_I = 10mA/0.5mA, DDTA144EE$ $I_O/I_I = 5mA/0.25mA, DDTA115EE$
Input Current	DDTA123EE DDTA143EE DDTA114EE DDTA124EE DDTA144EE DDTA115EE	I_I	—	—	-3.8 -1.8 -.88 -.36 -.18 -.15	mA	$V_I = -5V$
Output Current		$I_{O(off)}$	—	—	0.5	μA	$V_{CC} = -50V, V_I = 0V$
DC Current Gain	DDTA123EE DDTA143EE DDTA114EE DDTA124EE DDTA144EE DDTA115EE	G_I	-20 -20 -30 -56 -68 -82	—	—	—	$V_O = -5V, I_O = -20mA$ $V_O = -5V, I_O = -10mA$ $V_O = -5V, I_O = -5mA$ $V_O = -5V, I_O = -5mA$ $V_O = -5V, I_O = -5mA$ $V_O = -5V, I_O = -5mA$
Input Resistor (R_1) Tolerance		DR_1	-30	—	+30	%	—
Resistance Ratio		R_2/R_1	0.8	1	1.2	—	—
Gain-Bandwidth Product*		f_T	—	250	—	MHz	$V_{CE} = -10V, I_E = 5mA,$ $f = 100MHz$

* Transistor - For Reference Only

Ordering Information (Note 2)

Device	Packaging	Shipping
DDTA123EE-7	SOT-523	3000/Tape & Reel
DDTA143EE-7	SOT-523	3000/Tape & Reel
DDTA114EE-7	SOT-523	3000/Tape & Reel
DDTA124EE-7	SOT-523	3000/Tape & Reel
DDTA144EE-7	SOT-523	3000/Tape & Reel
DDTA115EE-7	SOT-523	3000/Tape & Reel

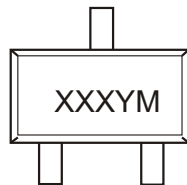
Notes: 2. For Packaging Details, go to our website at <http://www.diodes.com/datasheets/ap02007.pdf>.**Marking Information**

XXX = Product Type Marking Code (See Page 1, e.g. P04 = DDTA123EE)

YM = Date Code Marking

Y = Year ex: N = 2002

M = Month ex: 9 = September

Date Code Key

Year	2002	2003	2004	2005	2006	2007	2008	2009
Code	N	P	R	S	T	U	V	W

Month	Jan	Feb	March	Apr	May	Jun	Jul	Aug	Sep	Oct	Nov	Dec
Code	1	2	3	4	5	6	7	8	9	O	N	D

TYPICAL CURVES - DDTA143E

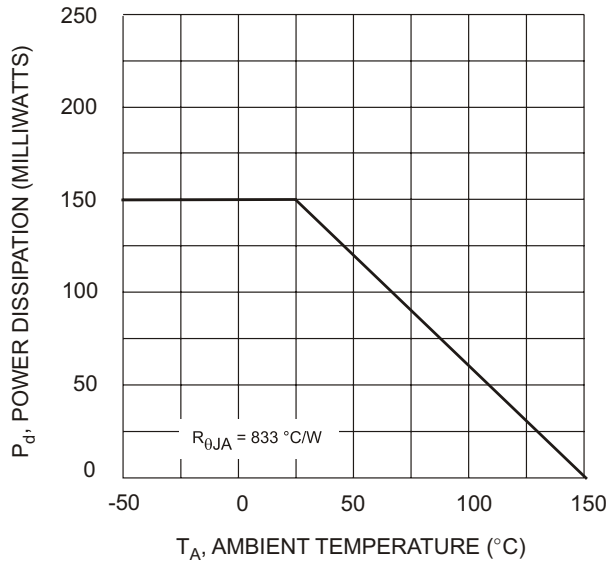

Fig. 1 Derating Curve

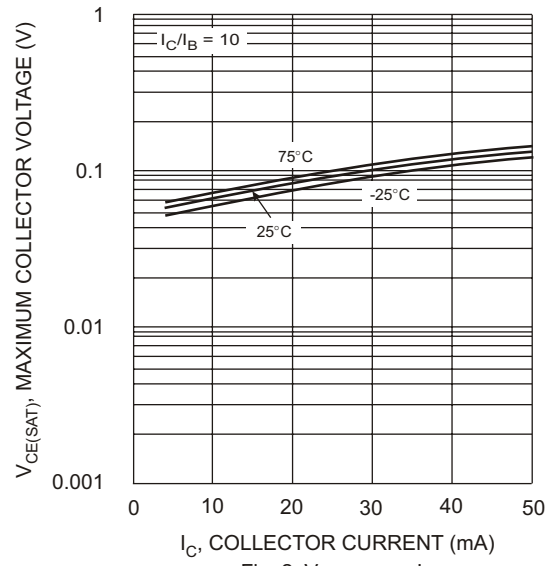

Fig. 2 $V_{CE(SAT)}$ vs. I_C

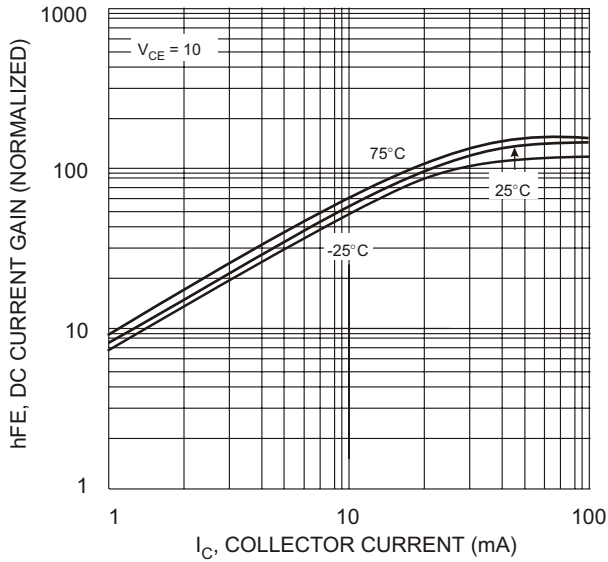

Fig. 3 DC CURRENT GAIN

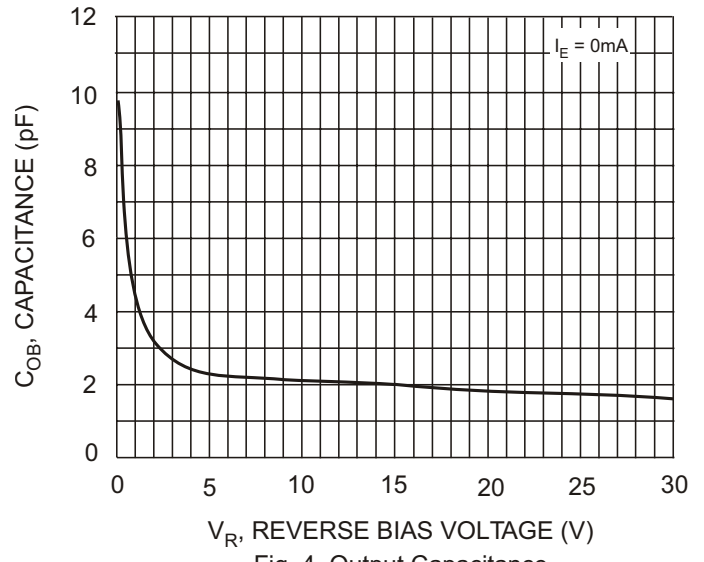

Fig. 4 Output Capacitance

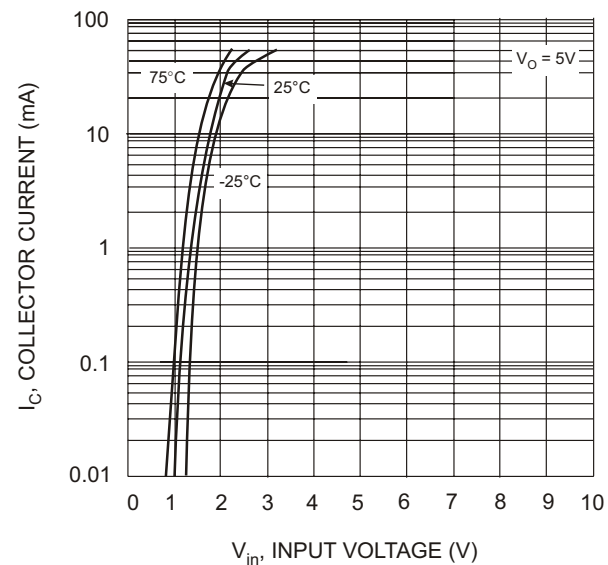

Fig. 5 Collector Current Vs. Input Voltage

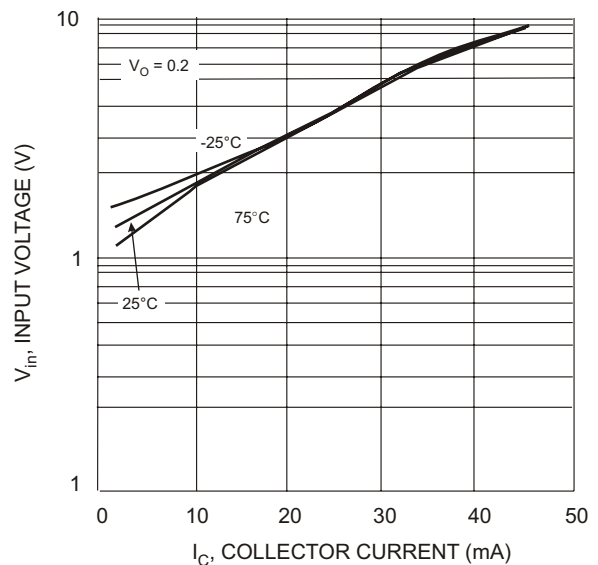

Fig. 6 Input Voltage vs. Collector Current