



DDTA (R1 R2 SERIES) UA

PNP PRE-BIASED SMALL SIGNAL SOT-323 SURFACE MOUNT TRANSISTOR

Features

- Epitaxial Planar Die Construction
- Complementary NPN Types Available (DDTC)
- Built-In Biasing Resistors, R1 R2

Mechanical Data

- Case: SOT-323, Molded Plastic
- Case material - UL Flammability Rating 94V-0
- Moisture sensitivity: Level 1 per J-STD-020A
- Terminals: Solderable per MIL-STD-202, Method 208
- Terminal Connections: See Diagram
- Marking: Date Code and Marking Code (See Diagrams & Page 3)
- Weight: 0.006 grams (approx.)

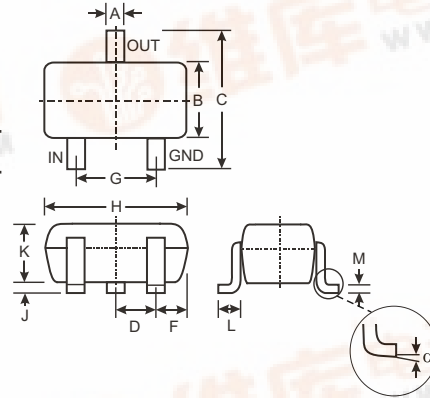

SOT-323		
Dim	Min	Max
A	0.25	0.40
B	1.15	1.35
C	2.00	2.20
D	0.65 Nominal	
E	0.30	0.40
G	1.20	1.40
H	1.80	2.20
J	0.0	0.10
K	0.90	1.00
L	0.25	0.40
M	0.10	0.18
	0	8
All Dimensions in mm		

P/N	R1 (NOM)	R2 (NOM)	MARKING
DDTA113ZUA	1K	10K	P02
DDTA123YUA	2.2K	10K	P05
DDTA123JUA	2.2K	47K	P06
DDTA143XUA	4.7K	10K	P09
DDTA143FUA	4.7K	22K	P10
DDTA143ZUA	4.7K	47K	P11
DDTA114YUA	10K	47K	P14
DDTA114WUA	10K	4.7K	P15
DDTA124XUA	22K	47K	P18
DDTA144VUA	47K	10K	P21
DDTA144WUA	47K	22K	P22

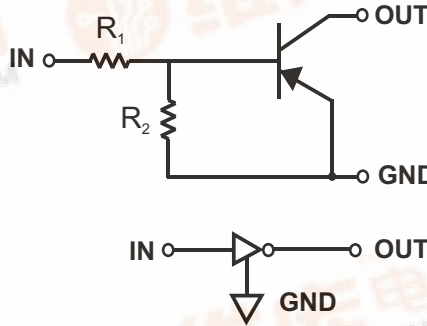

SCHEMATIC DIAGRAM

Maximum Ratings @ T_A = 25 °C unless otherwise specified

Characteristic	Symbol	Value	Unit
Supply Voltage, (3) to (1)	V _{CC}	-50	V
Input Voltage, (2) to (1)	V _{IN}	+5 to -10 +5 to -12 +5 to -12 +7 to -20 +6 to -30 +5 to -30 +6 to -40 +10 to -30 +10 to -40 +15 to -40 +10 to -40	V
Output Current	I _O	-100 -100 -100 -100 -100 -100 -70 -100 -50 -30 -30	mA
Output Current	I _C (Max)	-100	mA
Power Dissipation	P _d	200	mW
Thermal Resistance, Junction to Ambient Air (Note 1)	R _{JA}	625	C/W
Operating and Storage and Temperature Range	T _J , T _{STG}	-55 to +150	C

Note: 1. Mounted on FR4 PC Board with recommended pad layout at <http://www.diodes.com/datasheets/ap02001.pdf>.

NEW PRODUCT



Electrical Characteristics @ T_A = 25 C unless otherwise specified

Characteristic		Symbol	Min	Typ	Max	Unit	Test Condition
Input Voltage	DDTA113ZUA DDTA123YUA DDTA123JUA DDTA143XUA DDTA143FUA DDTA143ZUA DDTA114YUA DDTA114WUA DDTA124XUA DDTA144VUA DDTA144WUA	V _{I(off)}	-0.3 -0.3 -0.5 -0.3 -0.3 -0.5 -0.3 -0.8 -0.4 -1.0 -0.8			V	V _{CC} = 5V, I _O = 100 A
	DDTA113ZUA DDTA123YUA DDTA123JUA DDTA143XUA DDTA143FUA DDTA143ZUA DDTA114YUA DDTA114WUA DDTA124XUA DDTA144VUA DDTA144WUA		V _{I(on)}				
Output Voltage		V _{O(on)}		-0.1	-0.3	V	I _O /I _I = -5mA/-0.25mA DDTA123JUA I _O /I _I = -5mA/-0.25mA DDTA143ZUA I _O /I _I = -5mA/-0.25mA DDTA114YUA I _O /I _I = -10mA/-0.5mA All Others
Input Current	DDTA113ZUA DDTA123YUA DDTA123JUA DDTA143XUA DDTA143FUA DDTA143ZUA DDTA114YUA DDTA114WUA DDTA124XUA DDTA144VUA DDTA144WUA	I _I			-7.2 -3.8 -3.6 -1.8 -1.8 -1.8 -0.88 -0.88 -0.36 -0.16 -0.16	mA	V _I = -5V
Output Current		I _{O(off)}			-0.5	A	V _{CC} = -50V, V _I = 0V
DC Current Gain	DDTA113ZUA DDTA123YUA DDTA123JUA DDTA143XUA DDTA143FUA DDTA143ZUA DDTA114YUA DDTA114WUA DDTA124XUA DDTA144VUA DDTA144WUA	G _I	-33 -33 -80 -30 -68 -80 -68 -24 -68 -33 -56				V _O = -5V, I _O = -10mA
Input Resistor Tolerance		DR ₁	-30		+30	%	
Resistance Ratio Tolerance		DR ₂ /R ₁	-20		+20	%	
Gain-Bandwidth Product*		f _T		250		MHz	V _{CE} = -10V, I _E = 5mA, f = 100MHz

* Transistor - For Reference Only

Ordering Information (Note 2)

Device	Packaging	Shipping
DDTA113ZUA-7	SOT-323	3000/Tape & Reel
DDTA123YUA-7	SOT-323	3000/Tape & Reel
DDTA123JUA-7	SOT-323	3000/Tape & Reel
DDTA143XUA-7	SOT-323	3000/Tape & Reel
DDTA143FUA-7	SOT-323	3000/Tape & Reel
DDTA143ZUA-7	SOT-323	3000/Tape & Reel
DDTA114YUA-7	SOT-323	3000/Tape & Reel
DDTA114WUA-7	SOT-323	3000/Tape & Reel
DDTA124XUA-7	SOT-323	3000/Tape & Reel
DDTA144VUA-7	SOT-323	3000/Tape & Reel
DDTA144WUA-7	SOT-323	3000/Tape & Reel

Notes: 2. For Packaging Details, go to our website at <http://www.diodes.com/datasheets/ap02007.pdf>.

Marking Information

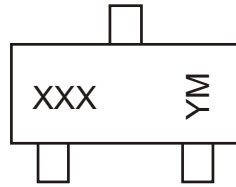

XXX = Product Type Marking Code
 See Sheet 1 Diagrams
 YM = Date Code Marking
 Y = Year ex: N = 2002
 M = Month ex: 9 = September

Date Code Key

Year	2002	2003	2004	2005	2006	2007	2008	2009
Code	N	P	R	S	T	U	V	W

Month	Jan	Feb	March	Apr	May	Jun	Jul	Aug	Sep	Oct	Nov	Dec
Code	1	2	3	4	5	6	7	8	9	O	N	D

TYPICAL CURVES - DDTA123JUA

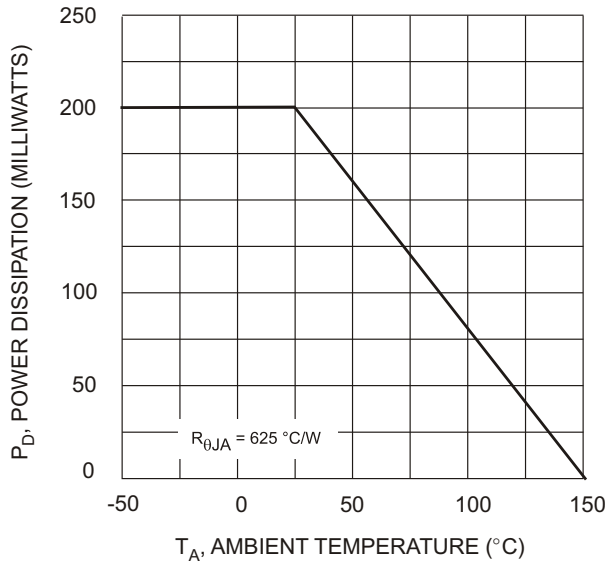

Fig. 1 Derating Curve

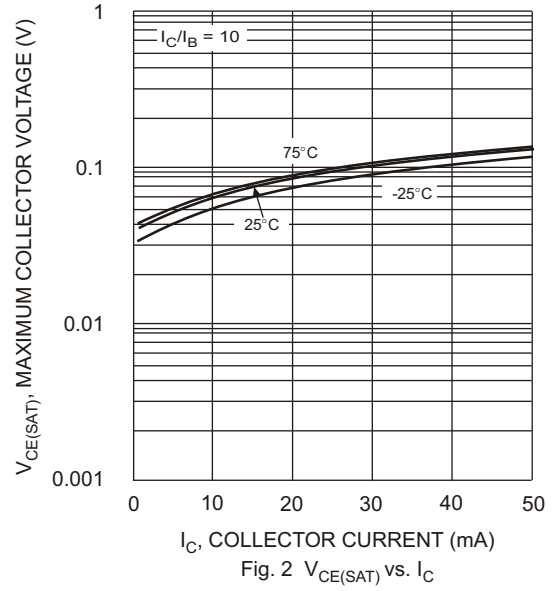

Fig. 2 V_{CE(SAT)} vs. I_C

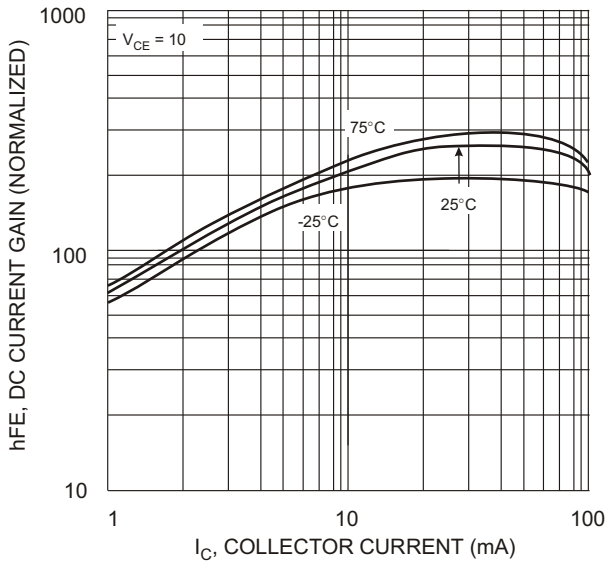

Fig. 3 DC CURRENT GAIN

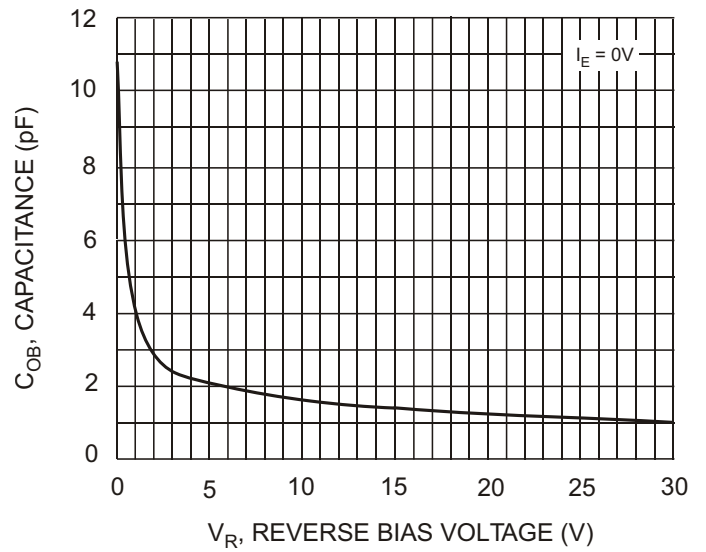

Fig. 4 Output Capacitance

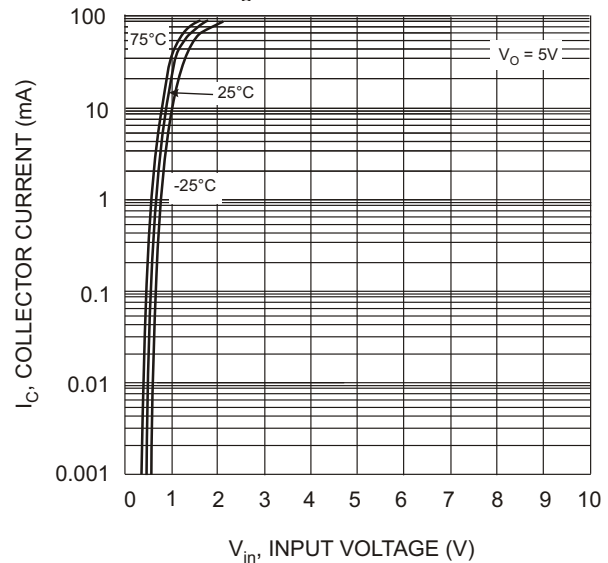

Fig. 5 Collector Current Vs. Input Voltage

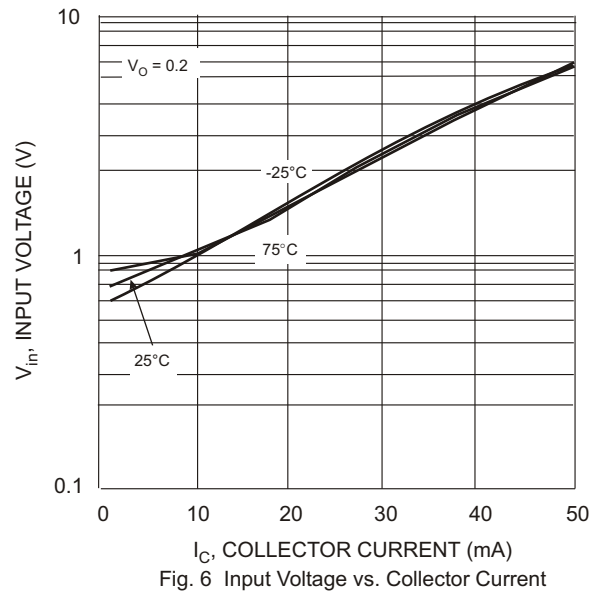

Fig. 6 Input Voltage vs. Collector Current